



gmm

**2025
CATALOG**



PROVIDING **AMMO** FOR ALL YOUR **ELECTRICAL** NEEDS



Extensive Inventory Selection

Explore a world of opportunities with our wide-ranging and diverse assortment of electrical supplies, catering to all your electrical requirements, ranging from fittings to various types of conduit pipes and accessories.

Streamlined Delivery Services:

We value your time and prioritize it. Our efficient shipping process guarantees your ordered items prompt and flawless arrival.

Customer Assistance:

Your satisfaction remains our utmost priority, and our dedicated customer support team embodies this dedication. Whether you have questions about product specifications or need guidance in selecting the ideal solutions for your project, our knowledgeable and friendly experts are here to assist you through the entire process. We don't just focus on products; we prioritize partnerships, ensuring that you make informed choices and achieve the most favorable results.



Affordable Pricing:

At AMMO Electric, we firmly believe that quality shouldn't be synonymous with high costs. We are dedicated to providing competitive pricing while upholding the highest standards of excellence. Our commitment to offering budget-friendly solutions enables you to successfully accomplish your projects without putting a strain on your budget.

Your Power Partner:

AMMO Electric's Resilient Service goes beyond mere product offerings; it's about forging lasting connections.

We're not just providers; we're collaborative partners in your ventures, striving together to enhance your achievements. Join us in reshaping the standards of excellence in electrical supply, delivery, and customer assistance. Reach out to us today, and let's ignite the potential of your possibilities to amplify your success. Join us in redefining excellence in electrical supply, delivery, and customer support. Contact us today and let's power up your possibilities. today and let's power up your possibilities.

 718 338 1851

 info@ammoelectric.com

 www.ammoelectric.com



LEADERSHIP TEAM



BOB FERENS

President

✉ bf@ammoelectric.com

BENNY DIDONATO

EVP of Sales and
Business Development

✉ benny@ammoelectric.com

KIRK NORMAN

National Sales Manager

✉ kn@ammoelectric.com

ADRIANA GÓMEZ

President of Operations

✉ adriana@ammoelectric.com

CHARLIE STOVER

VP of Sales

✉ charlie@ammoelectric.com

STEPHEN CARPENTER

Quotations Manager

✉ sc@ammoelectric.com

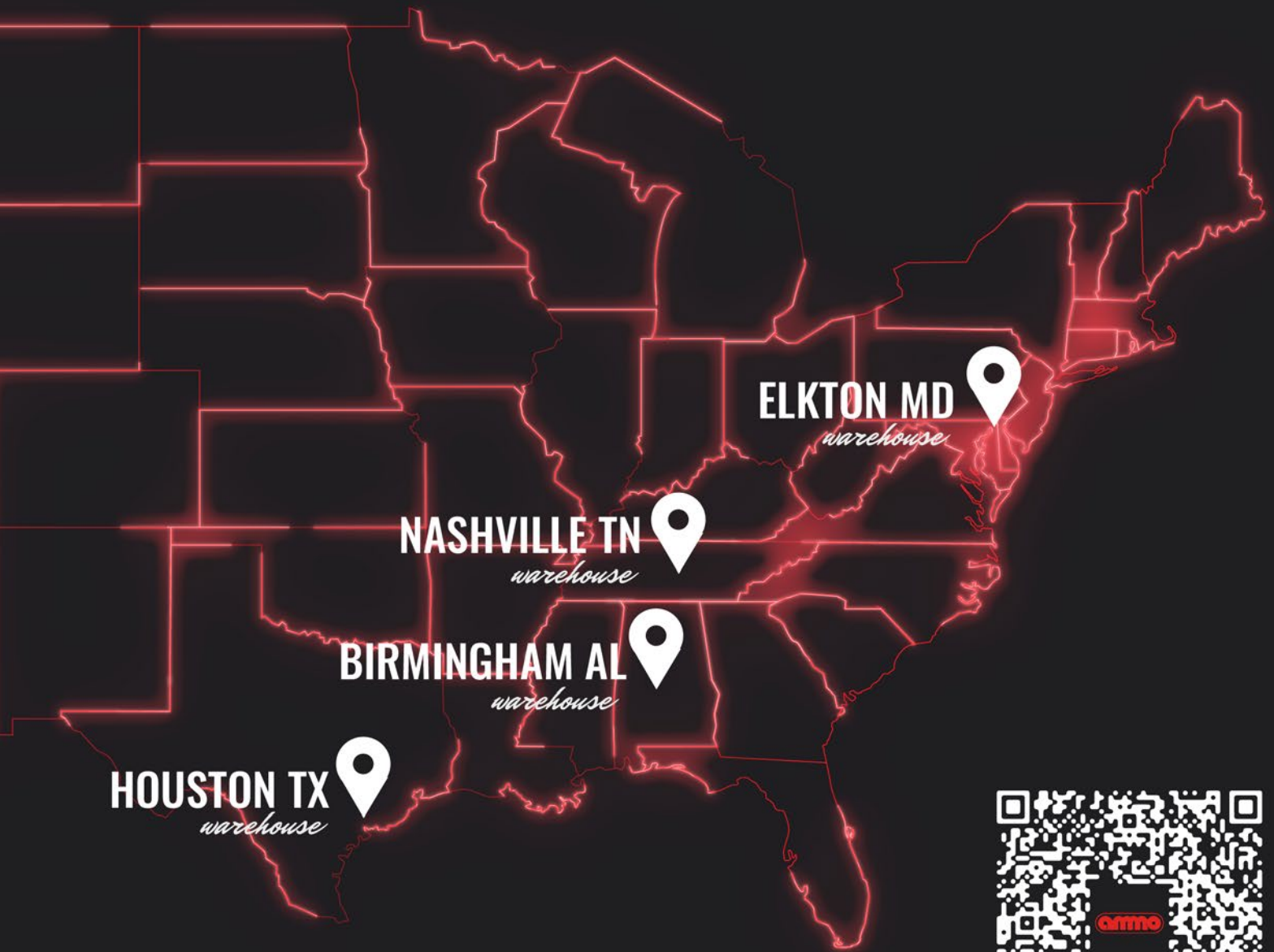

Please check our website for information about our representatives across the country.

<https://ammoelectric.com/authorized-representatives/>



TABLE OF CONTENTS

ELECTRICAL BOXES & COVERS

3-1/2" Octagon Boxes and Round Covers	10
Round Ceiling Pan	11
4" Octagon Boxes and Extension Rings 1-1/2" Deep	12
4" Octagon Boxes 1-1/2" Deep	14
4" Octagon Boxes 2-1/8" Deep	16
4" Octagon Round Covers	17
Square Boxes 1-1/2" and 1-1/4"	18
4" Square Boxes and Extension Rings	20
4" Square Extension Rings 1-1/2" Deep	22
4" Square Device and Tile Rings	24
4" Square Covers	25
4" Square Industrial Covers Raised	26
4" Square Industrial Covers Raised	28
4-11/16" Square Boxes	29
4-11/16" Square Device and Tile Rings	29
4-11/16" Square Boxes 2-1/8"	30
4-11/16" Square Combination Device and Tile Covers	31
4-11/16" Square Cover	32
4-11/16" Industrial Cover Raised	32
Hanger Bars	34
Box Mounting Brackets	35
Multi-Device Switch Boxes	36
Multi-Gang Switch Boxes Extension	38
Devices Covers for Gang Boxes	40
Multi Gang Box Covers	42
Masonry Boxes	43
Multi-Device Switch Boxes 2-1/2" Deep Welded	44
4" Octagon Concrete Rings	45
Octagon Concrete Ring Covers	46
4 X 2" Handy Boxes	47
4 X 2" Handy Box Covers	49
3 X 2" Switch Boxes	50
Add-A-Depth Ring	60
Blank Covers	61
Reducing Washers	62
Nail Safety Plates	63
Nail Drive Straps	63
Steel Knockout Seals	64
PVC New Work Boxes	65
PVC Old Work Boxes	67
Plastic Extension Rings	68



WEATHERPROOF

One Gang Weatherproof Boxes	72
Weatherproof Extension Single Gang	74
Two Gang Weatherproof Boxes	75
Closure Plug	78
Three Gang Weatherproof Box	79
One Gang Weatherproof Covers	80
Two Gang Weatherproof Covers	82
Three Gang Weatherproof Covers	82
In-Use Covers	83
Round Weatherproof Boxes	84
Lampholders	85
Lampholder Covers	86
Vapor Tight Light Fixtures	87
Service Entrance Caps	88



ELECTRICAL CONDUIT

Flexible Steel Conduit	92
Flexible Aluminum Conduit	93
ENT Conduit Coil	94
Flexible Liquid Tight Conduit	95
Liquid Tight Non-Metallic Tubing	96
EMT Conduit	97
True Color EMT	98
Rigid Steel Conduit	102
IMC Conduit	103
Aluminum Rigid Conduit	105



NIPPLES, ELBOWS & COUPLINGS

EMT Elbows	108
Rigid Elbows	110
Aluminum Elbows	112
Rigid Conduit Nipples	114
Rigid Couplings	118
Aluminum Couplings	119

PVC

PVC Conduit	122
Rigid PVC Conduit	123
PVC Conduit Bodies	126
PVC Elbow Sch40	128
PVC Elbow Sch80	130
PVC Fittings	132



CONDUIT BODIES

Aluminum Conduit Bodies	140
Mogul Conduit Bodies	142
Rigid/IMC Combination Conduit Bodies	144
EMT Conduit Bodies	146
Malleable Iron Conduit Bodies	148
Malleable Iron Form 7 Conduit Bodies	150
Conduit Body Covers	152



ELECTRICAL FITTINGS

EMT Connectors & Couplings	156
AC, MC, BX, Flex and NM Connectors	168
Bushings	183
Nylon Liquid Tight Connectors	184
Liquid Tight Connectors	186
Liquid Tight Malleable Iron Connectors	188
Rigid Connectors & Couplings	192
Grounding Bushings	196
Reducing Bushings	198
Plastic Bushings	199
Conduit Supports	200
Watertight Hubs	204
Locknuts	205
Chase Nipples	206
Offset Nipples	207
Strap EMT & BX	208
Straps Rigid	210
Metal Cable Staples	211
Insulated Connectors	212
Electrical Tape	216
Wire Connectors	217
Cable Ties	218



SPRING STEEL FASTENERS

Cable & Conduit _____	226
Beams & Purlins _____	236
Acoustical _____	239
Hanging & Hanging Support _____	241
Datacomm _____	243
Stud & Drywall _____	245



GROUNDING

Ground Rod _____	248
Bronze Ground Rod Clamps _____	249
Split Bolts _____	249
Grounding Fittings _____	250
Mechanical Lugs _____	252
Lugs _____	253
Compression Lugs _____	254
Grounding Bushbars _____	258
Ground Screws & Pigtails _____	259



STRUT & THREADED ROD

Threaded Rod _____	262
Strut Channels _____	263
Strut Fittings _____	265
Strut Clamps _____	266
Spring Nuts _____	267
Fitting Threaded Rod _____	268



ELECTRICAL WIRE

Cat 6 Wire _____	272
Cat 5 Wire _____	272
RG6 Dual/Quad _____	274
THHN Wire Stranded _____	275
THHN Wire Solid _____	287



WIRING DEVICES

GFCI'S & USB Devices _____	298
Residential Switches _____	300
Residential Receptacles _____	302
Industrial Receptacles & Plugs _____	308
Metal Wallplates _____	310
Plastic Wallplates _____	314
Red Indicator Plates _____	318
Ceiling Blank up Covers _____	319



LIGHTING AND ACCESSORIES

Lampholders _____	322
Vapor Tight Light Fixtures _____	325
Exit Signs _____	326
Emergency LED _____	327
Temporary Light Fixtures _____	328
Lamps _____	329
LED Work Lights _____	330
LED Strings _____	331



LINE SUPPLIES

Guy Clamps _____	334
Wire Rope Clips _____	334
Support Grip _____	334
Pipe Mounting Wireholders _____	335
Bolt & Anchors _____	336
Cable Storage Brackets _____	340
Nuts _____	341
Washers _____	341
Chains _____	342
Batteries _____	343



VENTILATION FANS

Fans _____	346
Fan Accessories _____	352

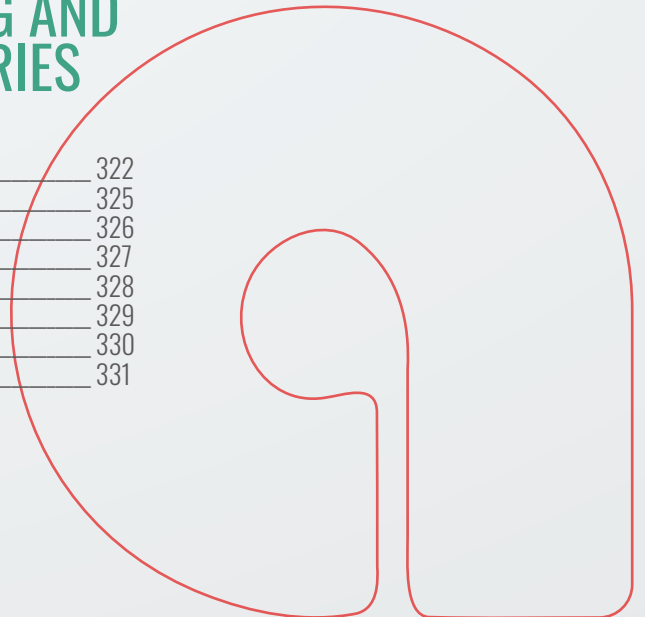

3-1/2" Octagon Boxes and _____	10	Masonry Boxes _____	43
Round Covers _____	10	Multi-Device Switch Boxes _____	44
Round Ceiling Pan _____	11	2-1/2" Deep Welded _____	44
4" Octagon Boxes and _____	12	4" Octagon Concrete Rings _____	45
Extension Rings 1-1/2" Deep _____	12	Octagon Concrete Ring Covers _____	46
4" Octagon Boxes 1-1/2" Deep _____	14	4" x 2" Handy Boxes _____	47
4" Octagon Boxes 2-1/8" Deep _____	16	4" x 2" Handy Box Covers _____	49
4" Octagon Round Covers _____	17	3" x 2" Switch Boxes _____	50
Square Boxes 1-1/2" and 1-1/4" _____	18	Add-A-Depth Ring _____	60
4" Square Boxes and Extension Rings _____	20	Blank Covers _____	61
4" Square Extension Rings 1-1/2" Deep _____	22	Reducing Washers _____	62
4" Square Device and Tile Rings _____	24	Nail Safety Plates _____	63
4" Square Covers _____	25	Nail Drive Strap _____	63
4" Square Industrial Covers Raised _____	26	Steel Knockout Seals _____	64
4" Square Industrial Covers Raised _____	28	PVC New Work Boxes _____	65
4-11/16" Square Boxes _____	29	PVC Old Work Boxes _____	67
4-11/16" Square Device and Tile Rings _____	29	Plastic Extension Rings _____	68
4-11/16" Square Boxes 2-1/8" _____	30		
4-11/16" Square Combination _____	31		
Device and Tile Covers _____	31		
4-11/16" Square Cover _____	32		
4-11/16" Industrial Cover Raised _____	32		
Hanger Bars _____	34		
Box Mounting Brackets _____	35		
Multi-Device Switch Boxes _____	36		
Multi-Gang Switch Boxes Extension _____	38		
Devices Covers for Gang Boxes _____	40		
Multi Gang Box Covers _____	42		

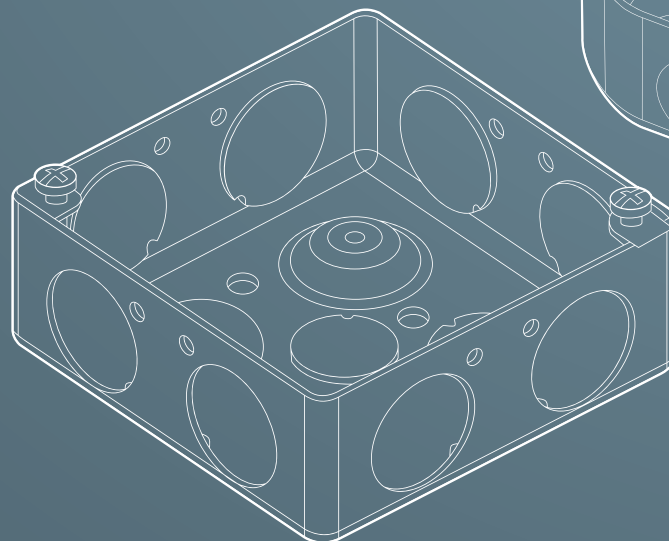
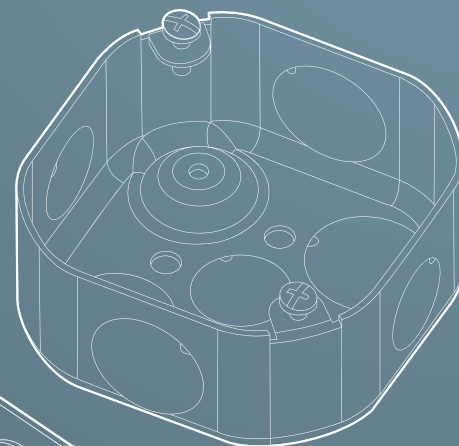
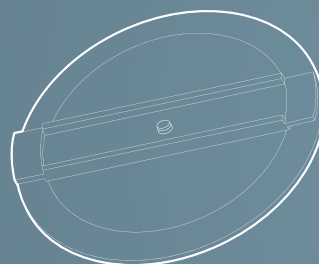

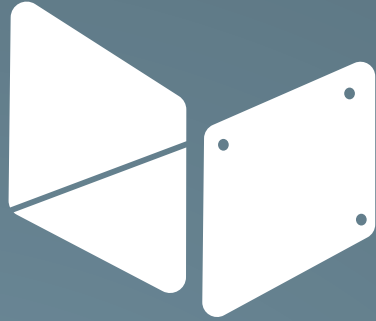

ELECTRICAL BOXES & COVERS





3-1/2" Octagon Boxes



 An octagon electrical box is a versatile and commonly used box that is typically used for installing light fixtures on a wall or ceiling.

AMMO#	SIDE KO	BOTTOM KO	BRACKET, SETBACK	PKG
AR110	(4)1/2"	(1)1/2"	-	50
AR111	(4)1/2"	-	-	50
AR112	4 Cables, (2)-1/2"	(1)-1/2"	NMSC Clamps	50



AR110



AR111

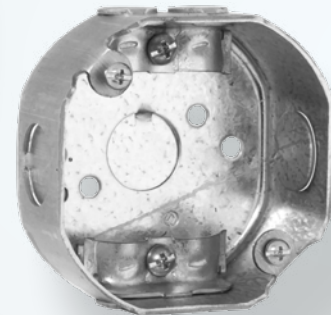

AR112



3-1/2" Round Covers

 Installation of cover without removing the box screws, used to close 3-1/2" octagon boxes when used as junction boxes.



AMMO#	DESCRIPTION	PKG
AR703	Flat, 1/2" KO	100

3-1/2" Round Ceiling Pan

1/2" Deep
6.0 Cu In Drawn



AMMO#	BOTTOM KO	BRACKET, SETBACK	PKG
AR292	(1)1/2"	NM Clamps	50



AR292



AR293

Round ceiling pans are manufactured from pre-galvanized steel, designed to house and protect electrical wiring and support light fixtures.

4" Round Ceiling Pan

1/2" Deep
6.0 Cu In Drawn



AMMO#	BOTTOM KO	BRACKET, SETBACK	PKG
AR293	(5)1/2"	-	50

4" Octagon Boxes and Extension Rings

1-1/2" Deep
15.5 Cu In Drawn



An octagon electrical box is a versatile and commonly used box that is typically used for installing light fixtures on a wall or ceiling.

AMMO#	SIDE KO	BOTTOM KO	BRACKET, SETBACK	PKG
AR125	(4)1/2"	(4)1/2"	-	50
AR126	(4) 3/4"	(2) 1/2", (2) 3/4"	-	50
AR127	(2)1/2", (2)3/4"	(2)1/2", (2)3/4"	-	50
AR128	(4)1/2"	-	-	50
AR129	(8)1/2, 3/4"	-	-	50
AR130	(2)1/2", (2)3/4"	-	-	50
AR145	4 Cables, (2)1/2"	(1)1/2"	-	50
AR146	4 Cables (2)1/2"	(1)1/2"	-	50
AR150	4 Cables (2)1/2"	(1)1/2"	-	50
AR4RB-MKO	(1)1/2", (2)MKO	(3)1/2", (2)3/4" FB, 1/2"	-	50
AR152	4 Cables 1/2"	(1) 1/2"	F BRKT, 1/2"	50
AR4RB-MKO-FB	(2)1/2", (2)MKO	(3)1/2", (2)3/4"	TS BRKT, 1/2"	50

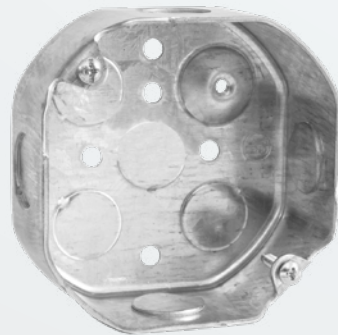

AR125

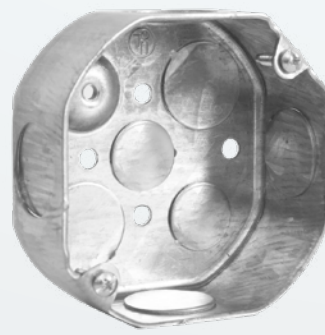

AR126



AR127



AR128



AR129



AR130

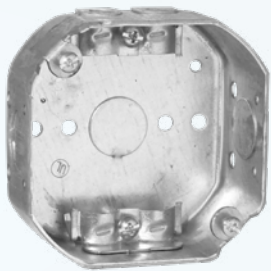

AR145

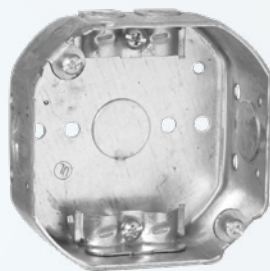

AR146



AR150



AR4RB-MKO

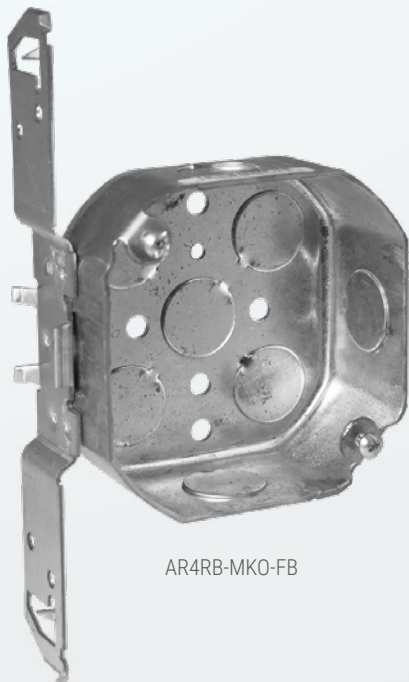

AR4RB-MKO-FB

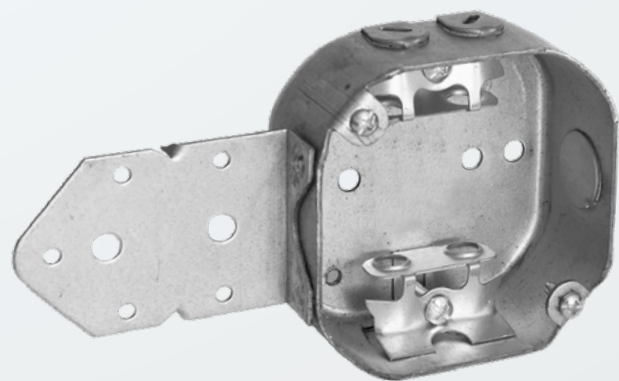

AR152

4" Octagon Boxes 1-1/2" Deep 15.5 Cu In Drawn



An octagon electrical box is a versatile and commonly used box that is typically used for installing light fixtures on a wall or ceiling.

AMMO#	SIDE KO	BOTTOM KO	BRACKET, SETBACK	PKG
AR153	4 Cables, (2)1/2"	(1)1/2"	AC/MC/Flex Clamps	50
AR158	(4)1/2"	(5)1/2"	J BRKT, 1/2"	50
AR160	4 Cables, (2)1/2"	(1)1/2"	J BRKT, 1/2"	50
AR155	4 Cables, (1)1/2"	(1)1/2"	TS BRKT, 1/2"	50
AR157	4 Cables, (2)1/2"	(1)1/2"	J BRKT, 1/2"	50
AR161	(3)1/2"	(5)1/2"	TS BRKT, 1/2"	50
AR164	4 Cables, (1)1/2"	(1)1/2"	TS BRKT, 1/2"	50
AR324	(4) 1/2"	(4)1/2"	3/8"Stud, Adj.	25
AR325	4 Cables, (2)1/2"	-	3/8"Stud, Adj.	25
AR326	4 Cables, (2)1/2"	-	3/8"Stud, Adj.	25

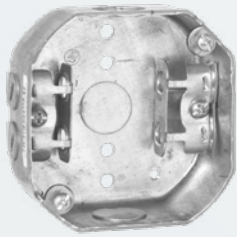

AR153



AR158

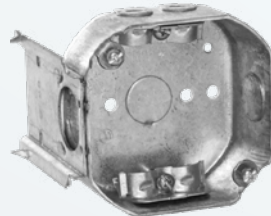

AR160



AR157

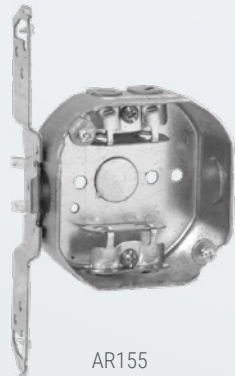

AR155

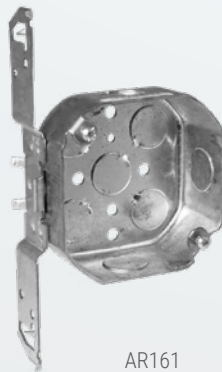

AR161

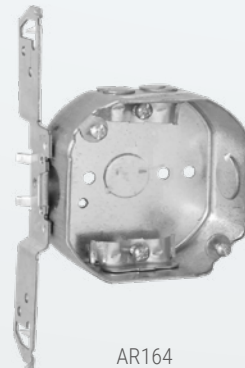

AR164



AR324

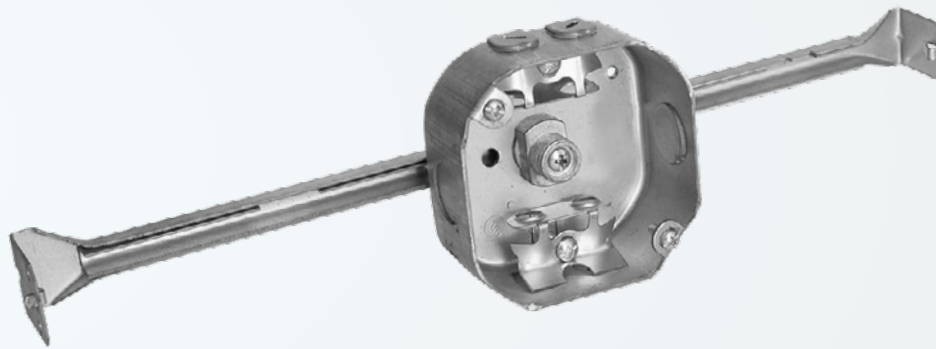

AR325

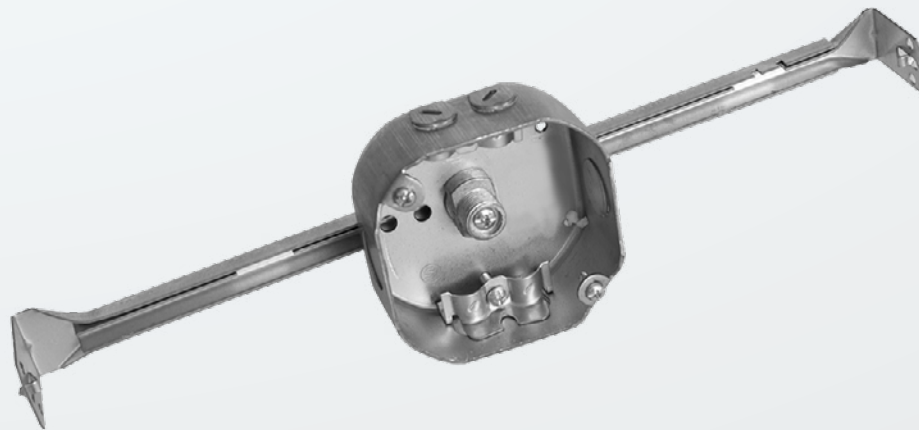

AR326

4" Octagon Boxes 2-1/8" Deep 21.50 Cu In Drawn



A deep octagon electrical box is a versatile and commonly used box that is typically used for installing light fixtures on a wall or ceiling where extra wires are needed

AMMO#	SIDE KO	BOTTOM KO	BRACKET, SETBACK	PKG
AR165	(4)1/2"	(5)1/2"	-	50
AR166	(4)3/4"	(2)1/2", (2)3/4"	-	50
AR167	(2)1/2", (2)3/4"	(2)3/4", (2)1/2"	-	50
AR175	4 Cables, (2)1/2"	(1)1/2"	-	50
AR176	4 Cables, (2)1/2"	(1)1/2"	J BRKT, 5/8"	25
AR177	4 Cables, (1)1/2"	(1)1/2"	TS BRKT, 1/2"	25



AR165

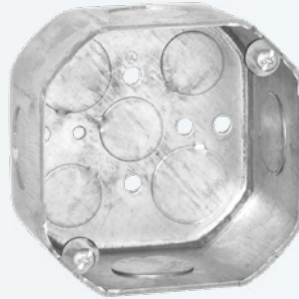

AR166

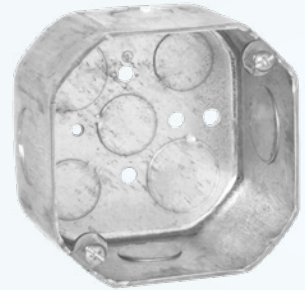

AR167



AR175

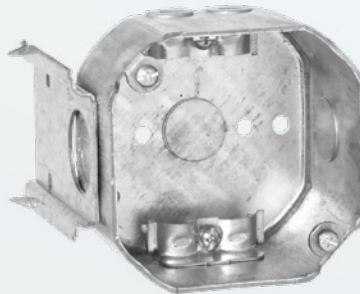

AR176

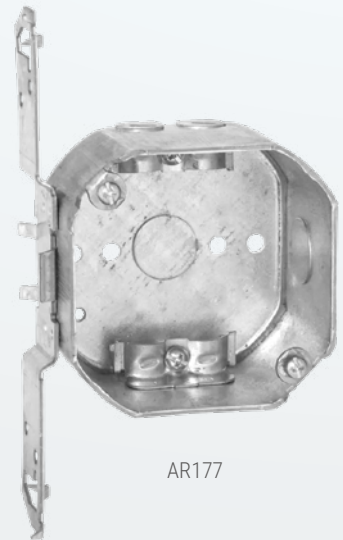

AR177

4" Octagon And Round Covers

Electrical Box Cover is used to seal off a 4" box to protect the wiring components inside.

AMMO#	DESCRIPTION	CU IN	PKG
AR722	Flat, Blank	-	100
AR724	Flat, 1/2" KO	-	100
AR729	Flat, Toggle Switch	-	100
AR731	Flat, Duplex Receptacle	-	100
AR4RBC-MKO	Flat, 1/2" KO In The Center	-	100
AR737	1/2" Raised	3.0	50
AR727	5/8" Raised	3.8	
AR4R075	3/4" Raised	5.0	50
AR732	1" Raised	6.5	25
AR4R125	1-1/4" Raised	8.5	25
AR4R150	1-1/2" Raised	9.5	25
AR4R200	2" Raised	12.8	25



AR722

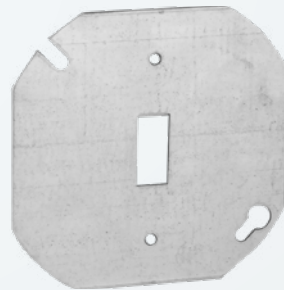

AR729



AR4RBC-MKO



AR724



AR731



AR737
AR727
AR4075
AR732
AR4R125
AR4R150
AR4R200

4" Square Boxes ^{1-1/4" Deep} 18.0 Cu In Drawn



4" Square Boxes and Extension Rings are used to install lighting fixtures, and switches, in ceilings and walls

AMMO#	SIDE KO	BOTTOM KO	PKG
AR185	(10)1/2"	(5)1/2"	50
AR187	(8)1/2", (4)3/4	-	50



AR185

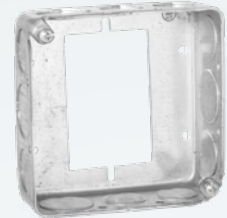

AR187

4" Square Boxes ^{1-1/2" Deep} 21.0 Cu In Welded



Extension Rings are used to install lighting fixtures, switches, in ceilings and walls

AMMO#	SIDE KO	BOTTOM KO	BRACKET, SETBACK	PKG
AR181	(8)3/4"	(1)1/2", (4)3/4"	-	50
AR189	(8)1/2", 4-EKO	(2)1/2", 2-EKO	-	50
AR193	(6)1/2", 3-EKO	(2)1/2", 2-EKO	B, Flush	24
AR196	(6)1/2", 3-EKO	(2)1/2", 2-EKO	FM, Flush	24

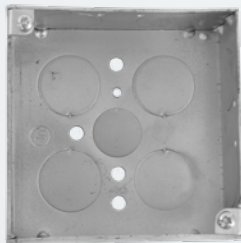

AR181

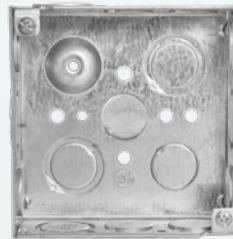

AR189

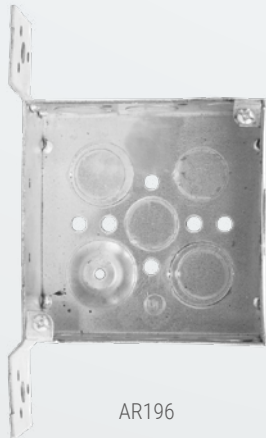

AR196

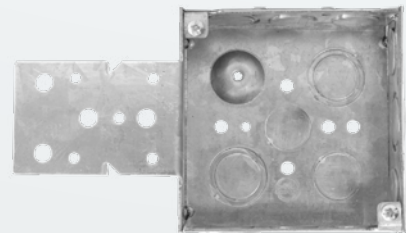

AR193

4" Square Boxes 1-1/2" Deep 21.0 Cu In Drawn

AMMO#	SIDE KO	BOTTOM KO	PKG
AR190	(12)1/2"	(4)1/2"	50
AR191	(8)3/4"	2-1/2", 2-3/4"	50
AR192	(8)1/2", (4)3/4"	(2)1/2", (2)3/4"	50



AR190



AR191



AR192



4" Square Boxes and Extension Rings

1-1/2" Deep 21.0 Cu In Welded



4" Square Boxes and Extension Rings are used to install lighting fixtures, and switches, in ceilings and walls

AMMO#	SIDE KO	BOTTOM KO	BRACKET, SETBACK	PKG
AR197	(6)1/2", 3-EKO	(3)1/2", 2-EKO	Fh, Flush	24
AR213	4 Cables, (4)1/2", 2-EKO	(1)1/2"	-	50
AR218	4 Cables, (2)1/2", 1-EKO	(1)1/2"	Fm, Flush	24
AR219	4 Cables, (2)1/2", 1-EKO	(1)1/2"	Fh, Flush	24
AR220	4 Cables, (2)1/2", 1-EKO	(1)1/2"	Fh, Flush	24
AR223	4 Cables, (2)1/2", 1-EKO	(1)1/2"	Fm, Flush	24
AR224	4 Cables, (2)1/2", 1-EKO	(1)1/2"	B, Flush	24
AR225	4 Cables, (2)1/2", 1-EKO	(1)1/2"	B, Flush	24
AR227	(6)1/2", 3-EKO	(3)1/2", 2-EKO	MS, Flush	24
AR228	4 Cables, (2)1/2", 1-EKO	(1)1/2"	MS, Flush	24
AR229	4 Cables, (2)1/2", 1-EKO	(1)1/2"	MS, Flush	24



AR197

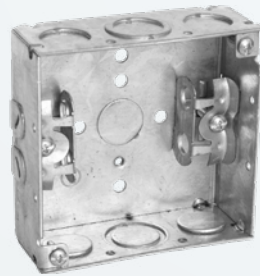

AR213

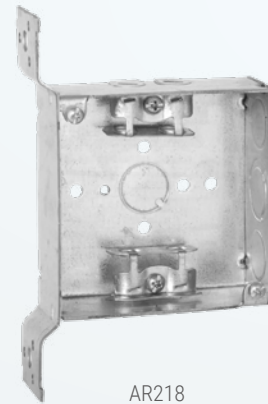

AR218

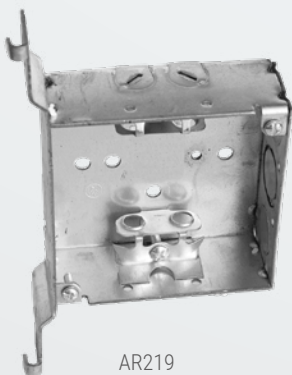

AR219

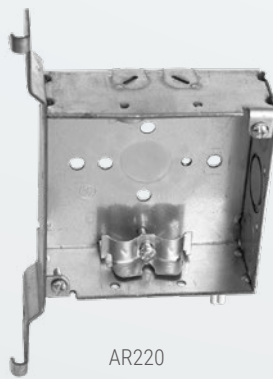

AR220

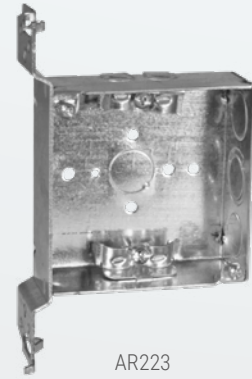

AR223

ELECTRICAL BOXES & COVERS

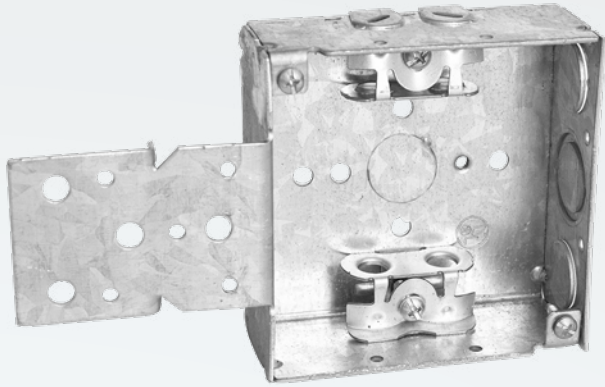

AR224

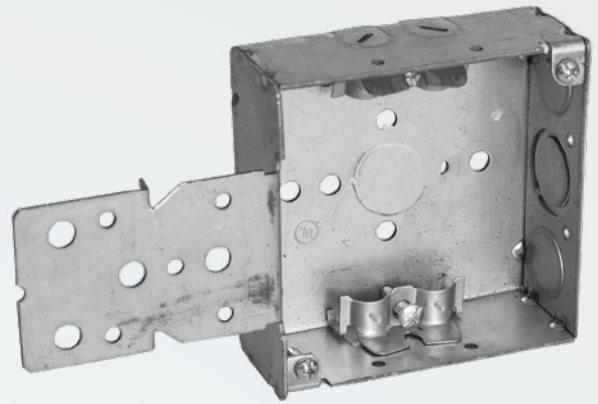

AR225

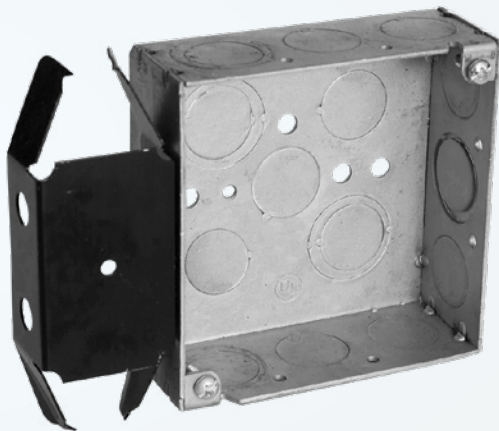

AR227

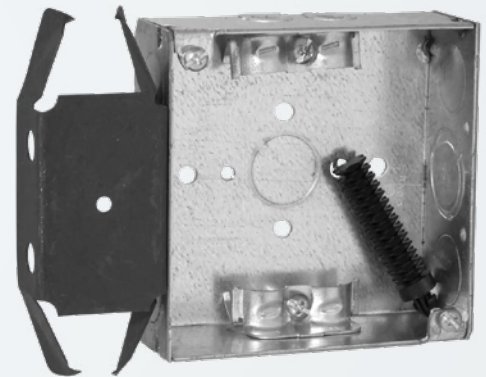

AR228

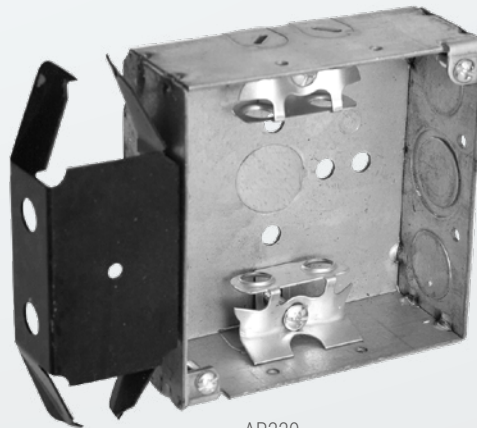

AR229

4" Square Extension Rings 1-1/2" Deep 22.5 Cu In Drawn



4" Square Boxes are used to install lighting fixtures, and switches, in ceilings and walls.

AMMO#	SIDE KO	PKG
AR201	(12)1/2"	50
AR202	(8)3/4"	50
AR203	(8)1/2", (4)3/4"	50

4" Square Boxes 2-1/8" Deep 30.3 Cu In Welded



4" Square Boxes are used to install lighting fixtures, and switches, in ceilings and walls.

AMMO#	SIDE KO	BOTTOM KO	BRACKET, SETBACK	PKG
AR231	(8)3/4"	(2)1/2", (2)3/4"	-	24
AR232	(8)1/2", 4-EKO	(2)1/2", 2-EKO	-	24
AR233	(8)1"	(2)1/2", (2)3/4"	-	24
AR242	4 Cables, (4)1/2", 2-EKO	(1)1/2"	-	24
AR244	(8)1/2", 4-EKO	(2)1/2", (2)3/4"	-	24
AR4SDB-50	(12)1/2"	-	-	24
AR4SDB-50/75	(8)1/2", (4)3/4"B	(2)1/2" KO, (2)3/4" KO	-	24
AR4SDB-75/100	(4)3/4", (4)1"	-	-	24
AR248	4 Cables, (4)1/2", 2-EKO	(1)1/2"	-	24
AR235	(6)1/2", 3-EKO	(2)1/2", 2-EKO	TS, Flush	24
AR236	(6)3/4"	(3)1/2", (2)3/4"	FM Flush	24
AR237	(6)1/2", 3-EKO	(3)1/2", 2-EKO	FM Flush	24
AR238	(6)1/2", 3-EKO	(3)1/2", 2-EKO	MS, Flush	24
AR240	4 Cables, (2) 1/2", 1-EKO	(1)1/2"	TS, Flush	24
AR241	4 Cables, (2) 1/2", 1-EKO	(1)1/2"	TS, Flush	24
AR243	4 Cables, (2)1/2", 1-EKO	(1)1/2"	MS, Flush	24
AR249	4 Cables, (3)1/2", (1)3/4"EKO		B, Flush AC/ MC/Flex Clamps	24
AR251	(9)1/2"	(5)1/2"	B Bracket	24



AR201



AR202



AR203



AR231



AR232



AR233



AR242



AR244



AR4SDB-50



AR4SDB-50/75



AR4SDB-75/100



AR248



AR235



AR236



AR237

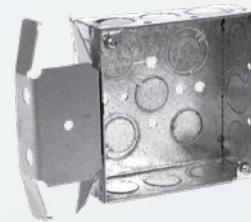

AR238

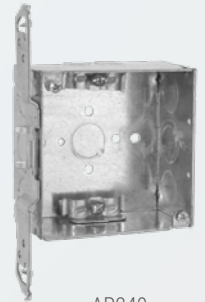

AR240

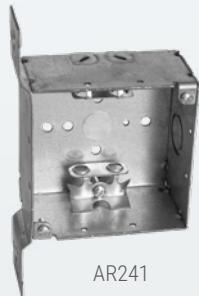

AR241

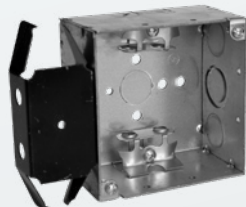

AR243

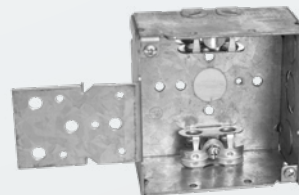

AR249

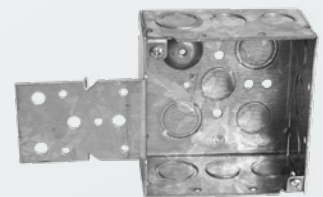

AR251

4" Square Combination Device And Tile Cover Single Device



Device Rings are used with 4" Square boxes to mount electrical fixtures, switches, and other devices.

AMMO#	DESCRIPTION	PKG
AR787	Flat	100
AR768	5/8" Raised	50
AR771	1/4" Raised	50
AR772	1/2" Raised,	50
AR773	3/4" Raised	50
AR774	1" Raised	25
AR775	1-1/4" Raised	25
AR785	1-1/2" Raised	25
AR786	2" Raised	25



AR787



AR768
AR771
AR772
AR773
AR774
AR775
AR785
AR786

4" Square Combination Device And Tile Cover



Raised device covers are used for mounting switches or receptacles



AR791



AR769
AR777
AR778
AR779
AR780
AR781
AR795
AR796

AMMO#	DESCRIPTION	CU IN	PKG
AR791	Flat	-	100
AR769	5/8" Raised,	7.5	50
AR777	1/4" Raised,	3.0	50
AR778	1/2" Raised,	5.8	50
AR779	3/4" Raised	8.8	50
AR780	1" Raised	11.8	25
AR781	1-1/4" Raised	14.5	25
AR795	1-1/2" Raised	15-5	25
AR796	2" Raised	20.7	25

4" Square Covers

Square covers are used to cover 4" square box wiring

AMMO#	DESCRIPTION	PKG
AR752	Flat, Blank	100
AR753	Flat, 1/2" KO	100
AR4BC-MKO	Flat, MKO	100
AR43000	Flat, Open	100
AR756	5/8" Raised	50
AR767	1/2" Raised	50
AR759	3/4" Raised	50
AR757	1" Raised	25
AR758	1-1/4" Raised	25
AR43150	1-1/2" Raised, Open, Ears, 2-3/4" O.C.	25
AR43200	2" Raised, Open, Ears, 2-3/4" O.C.	25

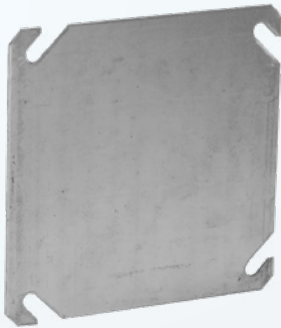

AR752

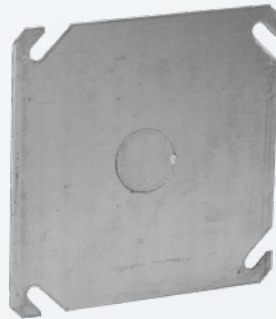

AR753



AR4BC-MKO



AR756

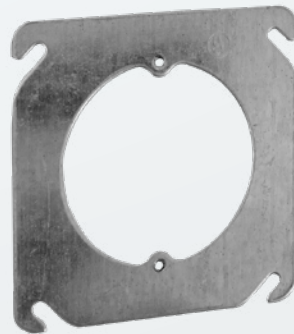

AR767

AR43000

AR759

AR757

AR758

AR43150

AR43200

4" Square Industrial Covers Raised 1/2"



AMMO#	DESCRIPTION	CU IN	PKG
AR800	1 Toggle	7.0	50
AR801	1 Receptacle 1.406" Dia	7.0	50
AR803	2 Toggle	7.0	50
AR808	1 GFCI/Decorator	7.0	50
AR809	2 GFCI/Decorator	7.0	50
AR810	30-50a Receptacle, 2.141" Dia	7.0	50
AR811	30a Locking, 1.719" Dia	7.0	50
AR812	20a Receptacle, 1.594" Dia	7.0	50
AR813	30-60a Receptacle, 2.625" Dia	7.0	50
AR814	1 GFCI & 1 Toggle Switch	7.0	50
AR902	1 Duplex Receptacle	7.0	50
AR906	1 Duplex & 1 Toggle Switch	7.0	50

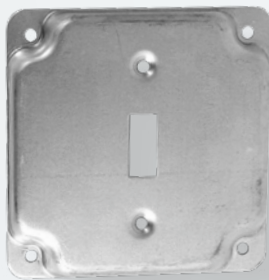

AR800



AR801



AR803



AR808



AR809



AR810



AR811



AR812



AR813

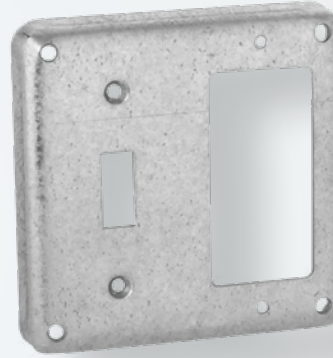

AR814



AR902

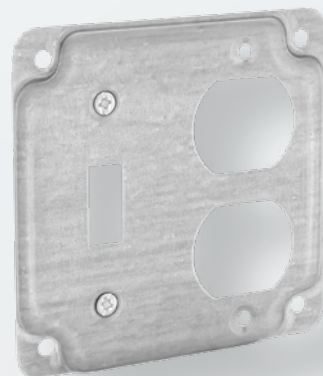

AR906

4" Square Industrial Covers Raised 1/2"



AMMO#	DESCRIPTION	CU IN	PKG
AR907	2 Duplex Receptacle	7.0	50
AR915	1 GFCI & Duplex Receptacle	7.0	50
AR4400	Blank	7.0	50
AR805	Toggle Switch / Single Receptacle	7.0	50
AR806	Duplex / Single Receptacle	7.0	50
AR4433	2 Single Receptacle, 1.406" Dia. Each	7.0	50



AR907

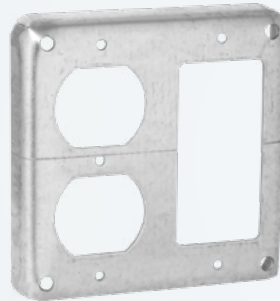

AR915

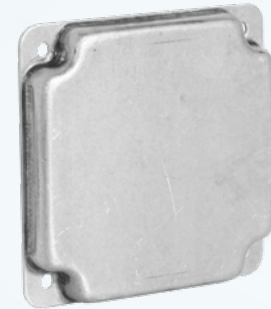

AR4400

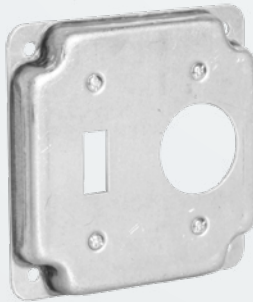

AR805

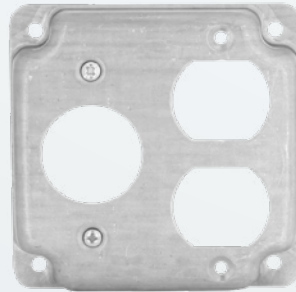

AR806

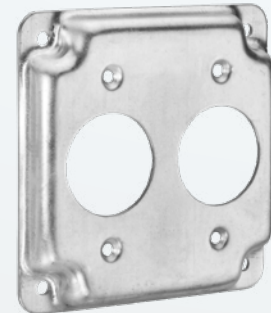

AR4433

4-11/16" Square Boxes 1-1/2" Deep 29.5 Cu In Drawn

4-11/16" Square Welded Boxes are used where large sized conductors or wiring devices are needed

AMMO#	SIDE KO	BOTTOM KO	PKG
AR245	(12)1/2"	(3)1/2", (2)3/4"	24
AR247	(4)3/4", (8)1/2"	(3)1/2", (2)3/4"	24

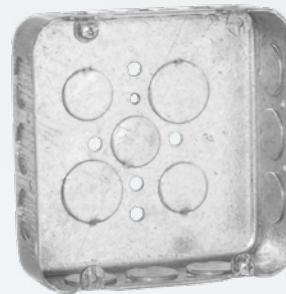

AR245



AR247

4-11/16" Square Boxes 2-1/8" Deep 42.0 Cu In Welded

AMMO#	SIDE KO	BOTTOM KO	BACKET, SETBACK	PKG
AR252	6-MKO, 4- Loom	(3)1/2", (2)3/4"	Clamps	24
AR259	(6)1-1/4"	(2)1/2", (2)3/4"	-	24
AR265	(4)3/4", (4)1"	(2)1/2", (2)3/4"	-	24
AR262	(8)1/2", (4)3/4"	-	-	24

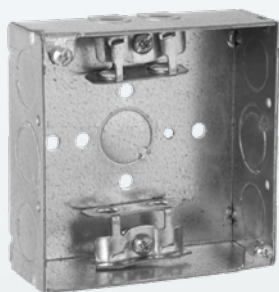

AR252

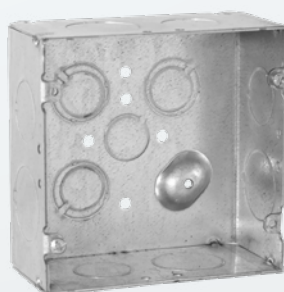

AR265

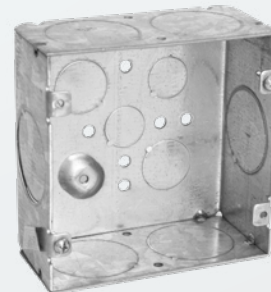

AR259

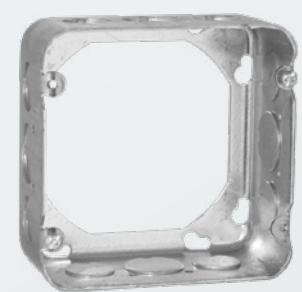

AR262



4-11/16" Square Boxes 2-1/8" Deep 42.0 Cu In Welded



 4-11/16 in. Square Welded Box are used where larger sized conductors or wiring devices are needed

AMMO#	SIDE KO	BOTTOM KO	BRACKET, SETBACK	PKG
AR257	12-EKO	(2)1/2", 2-EKO	-	24
AR258	(8)1"	(3)1/2", (2)3/4"	-	24
AR254	(2)1/2", 7-EKO	(3)1/2", 2-EKO	FM BRKT	24



AR257

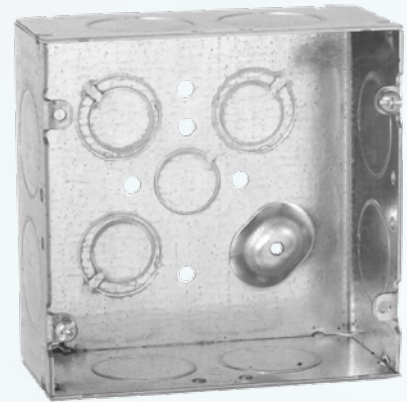

AR258

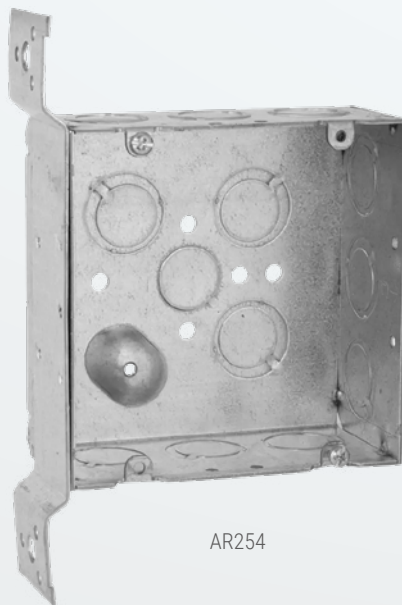

AR254

ELECTRICAL BOXES & COVERS

4-11/16" Square Combination Device And Tile Covers

Single Device

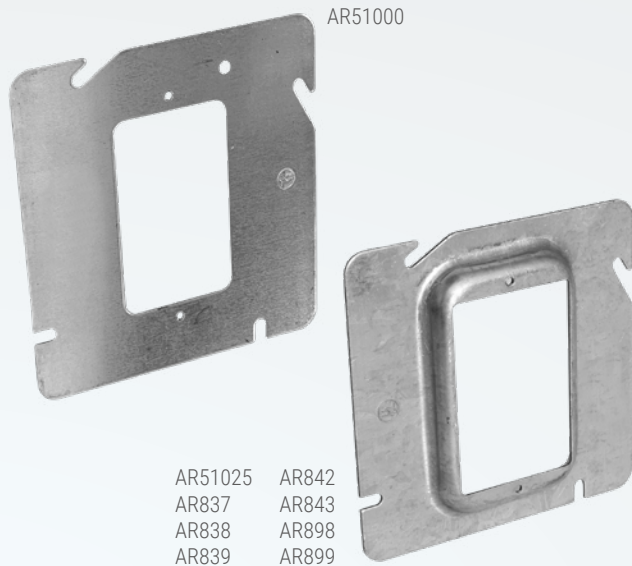

AR51025 AR842
AR837 AR843
AR838 AR898
AR839 AR899

AMMO#	DESCRIPTION	CU IN	PKG
AR51000	Flat	3.8	100
AR51025	1/4" Raised	5.5	50
AR837	1/2" Raised	3.8	50
AR838	3/4" Raised	5.5	50
AR839	1" Raised	7.5	50
AR842	1-1/4" Raised	9.4	50
AR843	5/8" Raised	4.3	50
AR898	1-1/2" Raised	11.0	50
AR899	2" Raised	14.3	50

4-11/16" Square Combination Device And Tile Covers

Two Devices



AMMO#	DESCRIPTION	CU IN	PKG
AR52000	2-3/4" OC Flat	5.8	100
AR52025	1/4" Raised	7.5	50
AR841	1/2" Raised	5.8	50
AR818	5/8" Raised	7.5	50
AR840	3/4" Raised	8.8	50
AR819	1" Raised	11.8	50
AR820	1-1/4" Raised	14.5	50
AR885	1-1/2" Raised	15.5	50
AR52200	2" Raised	20.5	50

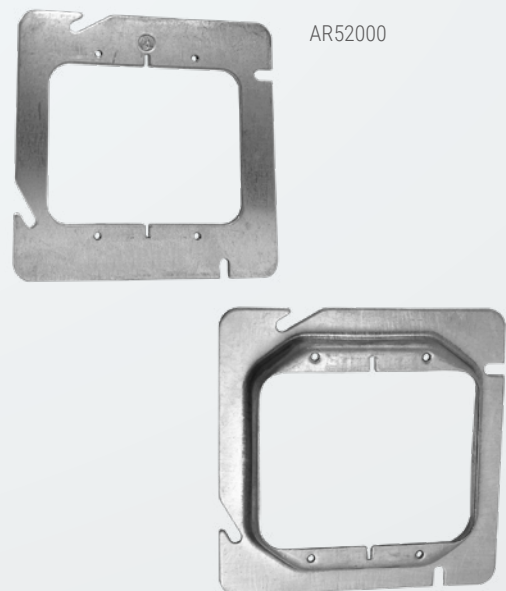

AR52025
AR841
AR818
AR819
AR820
AR840
AR885
AR52200



4-11/16" Square Covers



AMMO#	DESCRIPTION	CU IN	PKG
AR832	Flat, Blank	-	100
AR833	Flat, 1/2" KO In Center	-	100
AR5BC-MKO	Flat, MKO	-	100
AR53000	Flat, Open, Ears 2-3/4" O.C.	-	100
AR829	1/2" Raised, Open, Ears 2-3/4" O.C.	3.0	50
AR835	5/8" Raised, Open, Ears 2-3/4" O.C.	4.0	50
AR53075	3/4" Raised, Open, Ears 2-3/4" O.C.	5.0	50
AR53100	1" Raised, Open, Ears 2-3/4" O.C.	6.8	25
AR53125	1-1/4" Raised, Open, Ears 2-3/4" O.C.	8.5	25
AR53150	1-1/2" Raised, Open, Ears 2-3/4" O.C.	9.5	25
AR53200	2" Raised, Open, Ears 2-3/4" O.C.	12.8	25

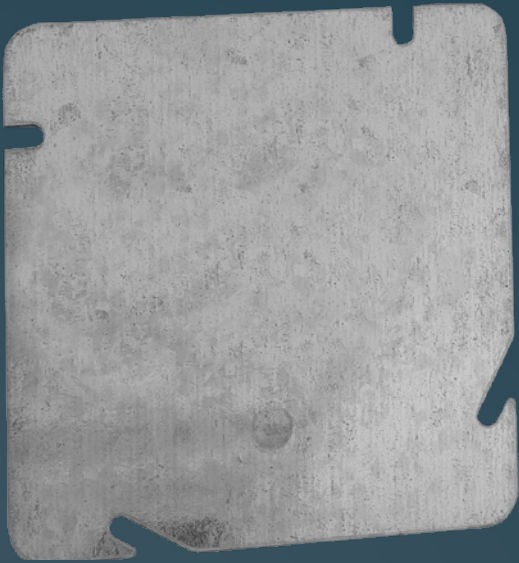

AR832



AR833



AR5BC-MKO



AR829 AR53100
AR53150 AR835
AR53075 AR53125
AR53200

Hanger Bars



Hanger bars are used to install electrical boxes that offset from stud walls

AMMO#	TYPE	RANGE	PKG
AR920	Adjustable Bar Hanger	14-1/4" To 22-1/2"	50
AR922	Adjustable Bar Hanger	16" To 24"	50
ART24	T-Bar Hanger	24"	50
AR512HD	Heavy Duty T-Bar Mount	24" Heavy Duty T-Bar Mount; 1 1/2" or 2 1/8" Boxes	25
AR925	Fan Support	16" To 24"	24



AR920
AR922

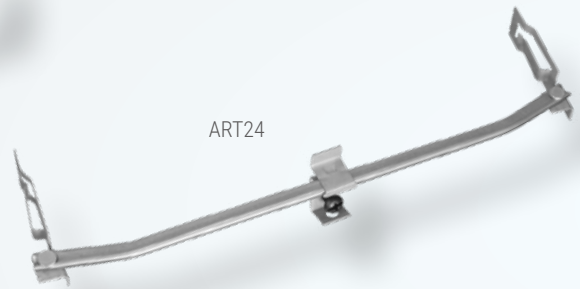

ART24



AR512HD



AR925

Adjustable Bar Hangers

AMMO#	RANGE	PKG
BHA-16	11" to 18"	50
BHA-24	15-3/4" to 26"	50



Box Mounting Brackets

AMMO#	SIZE	HOLE	PKG
ARBS16	4" or 4-11/16" Square	3	50
ARBS24	4" or 4-11/24" Square	4	50
AR23	4" or 4-11/16" Square	-	50
ARTSRB	Telescoping Rigid Box Support	16"-24" Stud Spacing	50
AB45P	4", 4 11/16", 5"	-	25
AB1624HD	14.5" to 25"	-	25
ARSSB-T5	4", 4-11/16", 5"	-	25



ARBS16

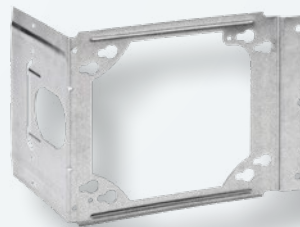

AR23

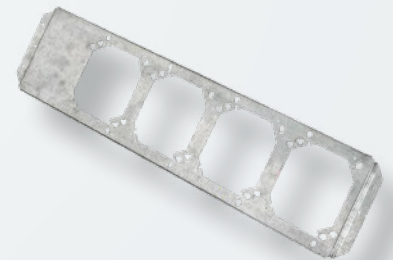

ARBS24



ARTSRB



AR45P



AB1624HD



ARSSB-T5

Multi-Device Switch Boxes 1-5/8" Deep Welded



Multi device switch boxes used to install multiple devices in one box location.

AMMO#	#GANGS	END KO	SIDE KO	BOTTOM KO	CU IN	PKG
AR951	2	4 EKO	8 EKO	(3)1/2", (2)3/4"	47.0	5
AR952	3	4 EKO	10 EKO	(6)1/2", (4)3/4"	60.0	5
AR953	4	4 EKO	12 EKO	(6)1/2", (4)3/4"	72.8	5
AR954	5	4 EKO	14 EKO	(6)1/2", (4)3/4"	85.5	5
AR955	6	4 EKO	16 EKO	(6)1/2", (4)3/4"	98.5	1
AR956	7	4 EKO	18 EKO	(9)1/2", (6)3/4"	111.5	1
AR957	8	4 EKO	20 EKO	(9)1/2", (6)3/4"	124.5	1
AR958	9	4 EKO	22 EKO	(9)1/2", (6)3/4"	137.3	1

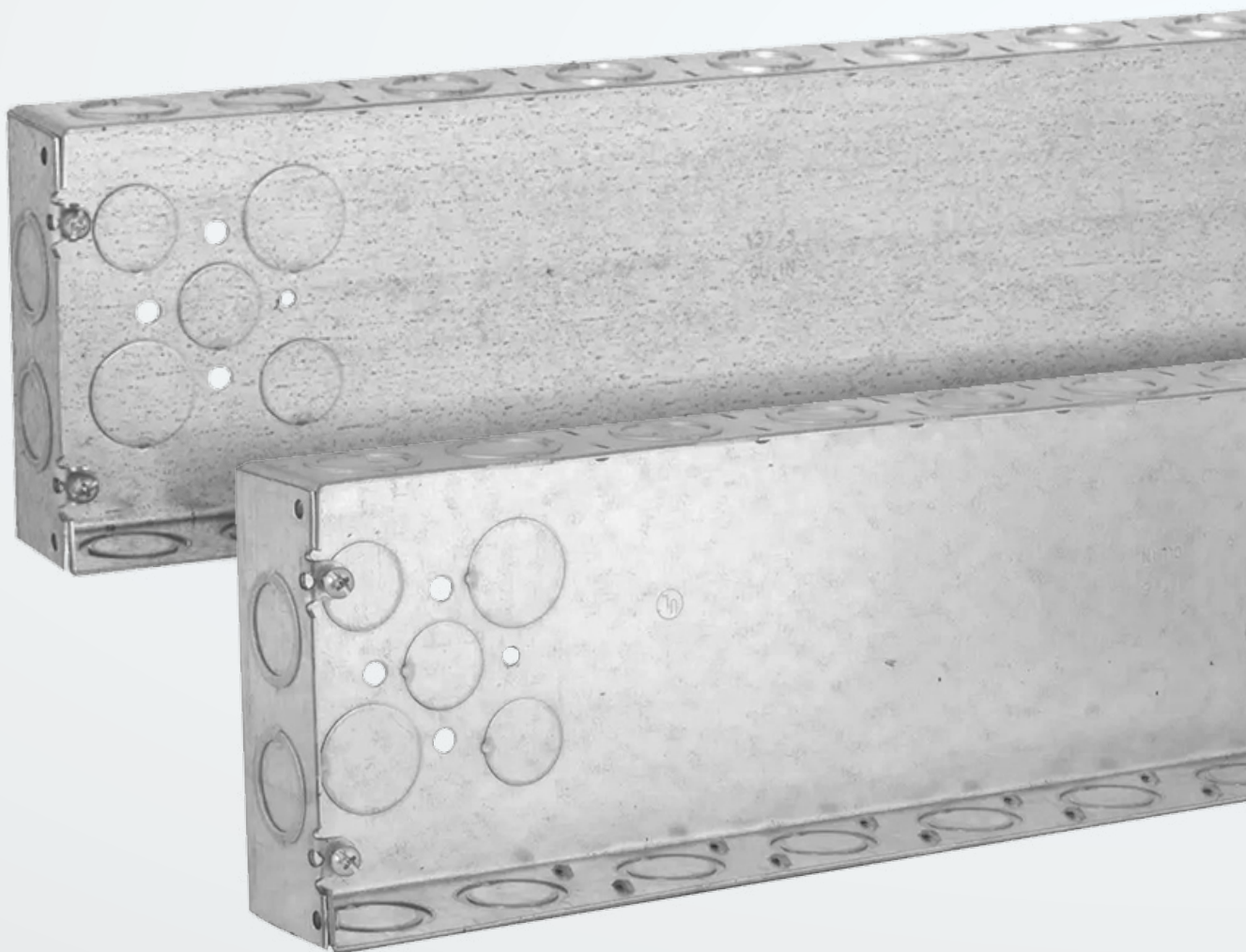

Multi-Device Switch Boxes 2-1/2" Deep

Multi device switch boxes used to install multiple devices in one box location.

AMMO#	#GANGS	END KO	SIDE KO	BOTTOM KO	CU IN	PKG
AR941	2	4 EKO	8 EKO	(3)1/2", (2)3/4"	47.0	5
AR942	3	4 EKO	10 EKO	(6)1/2", (4)3/4"	60.0	5
AR943	4	4 EKO	12 EKO	(6)1/2", (4)3/4"	72.8	5
AR944	5	4 EKO	14 EKO	(6)1/2", (4)3/4"	85.5	5
AR945	6	4 EKO	16 EKO	(6)1/2", (4)3/4"	98.5	5
AR946	7	4 EKO	18 EKO	(9)1/2", (6)3/4"	111.5	5
AR947	8	4 EKO	20 EKO	(9)1/2", (6)3/4"	124.5	5
AR948	9	4 EKO	22 EKO	(9)1/2", (6)3/4"	137.3	5





Multi Gang Switch Boxes Extension Rings 1-5/8" Deep Welded



 Welded galvanized steel construction extension rings are perfect when adding depth to the surface.

AMMO#	#GANGS	SIDE KO	CU IN	PKG
AR951-EXT	2	8 EKO	47.0	5
AR952-EXT	3	10 EKO	60.0	5
AR953-EXT	4	12 EKO	72.8	5
AR954-EXT	5	14 EKO	85.5	5
AR955-EXT	6	16 EKO	98.5	5
AR956-EXT	7	18 EKO	111.5	5
AR957-EXT	8	20 EKO	124.5	5
AR958-EXT	9	22 EKO	137.3	5

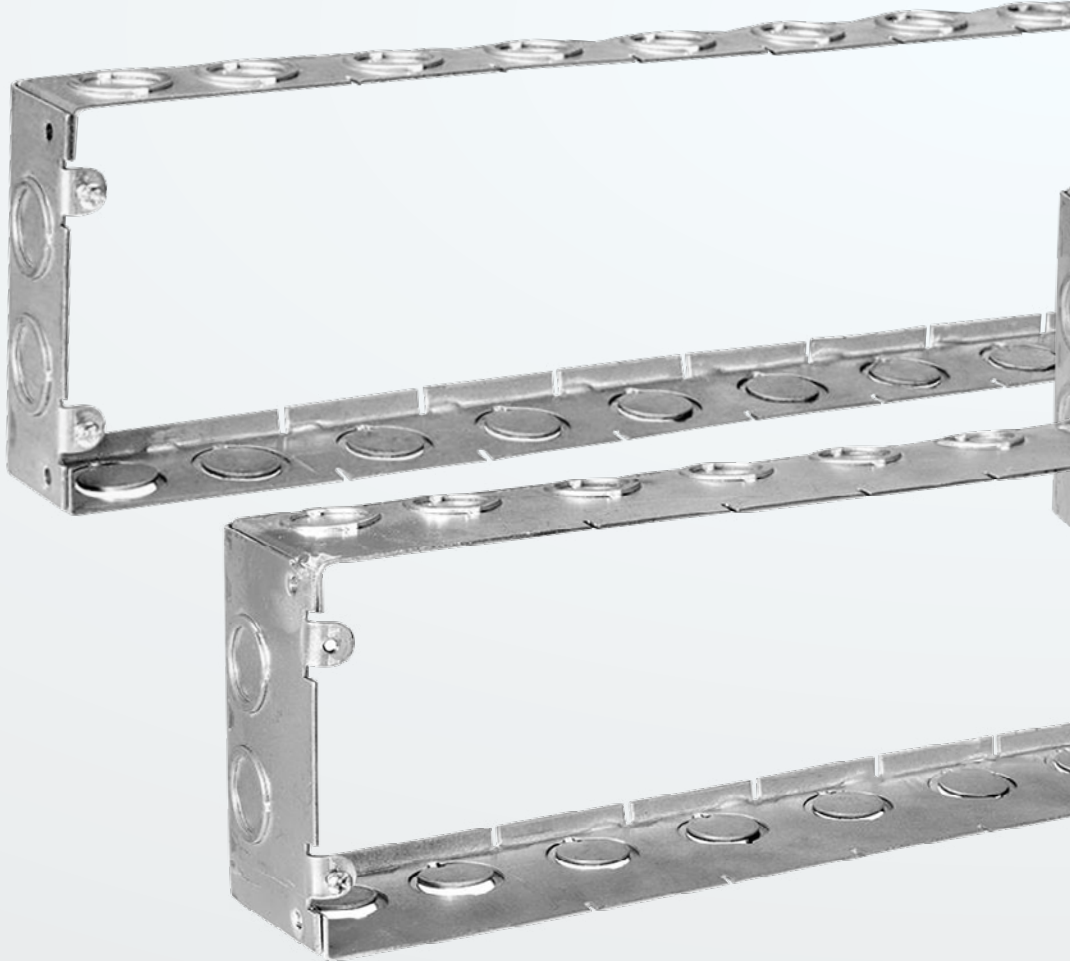

Multi Gang Switch Boxes Extension Rings 2-1/2" Deep Welded

AMMO#	#GANGS	DIMENSION	CU IN	PKG
AR941-EXT	2	1/2" & 3/4"	70.0	5
AR942-EXT	3	1/2" & 3/4"	90.0	5
AR943-EXT	4	1/2" & 3/4"	72.5	5
AR944-EXT	5	1/2" & 3/4"	130.0	5
AR945-EXT	6	1/2" & 3/4"	150.0	5
AR946-EXT	7	1/2" & 3/4"		5
AR947-EXT	8	1/2" & 3/4"	190.0	5
AR948-EXT	9	1/2" & 3/4"		5

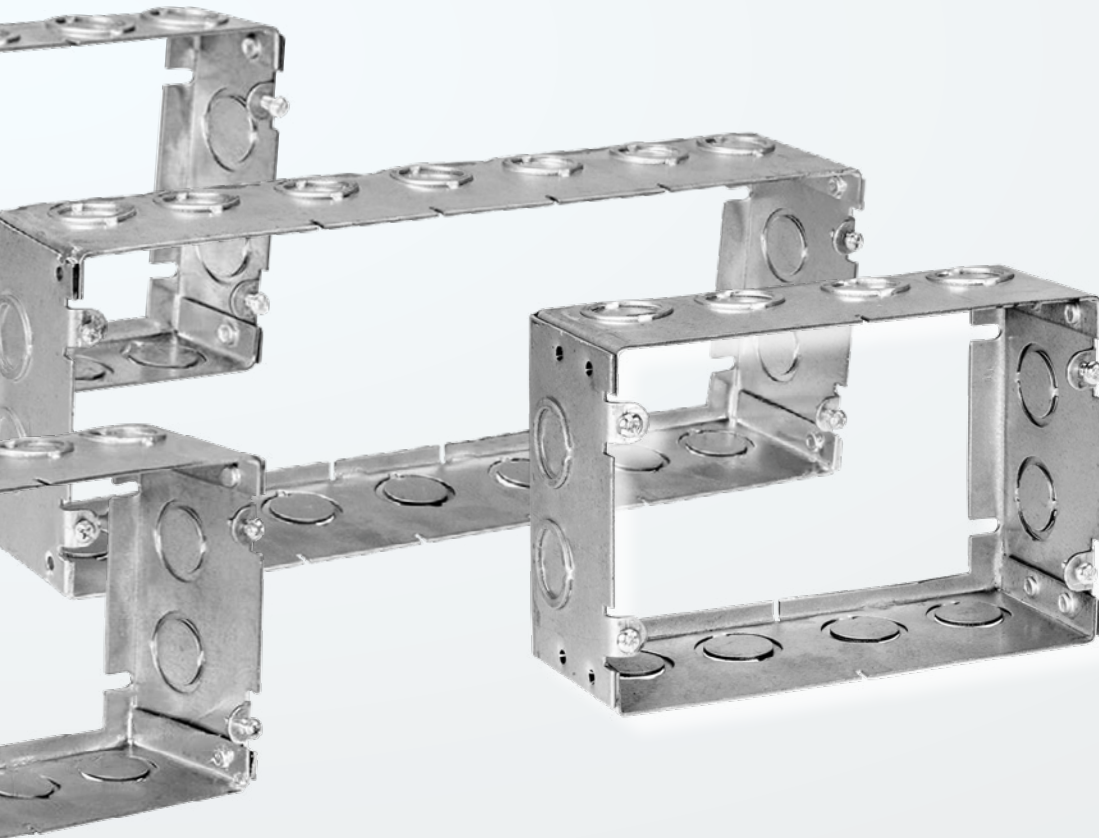

Device Covers For Gang Boxes Raised 1/2"



AMMO#	#GANGS	DIMENSION	CU IN	PKG
AR821-1/2	2	6-13/16"	9.1	5
AR822-1/2	3	8-5/8"	14.9	5
AR823-1/2	4	10-7/16"	21.0	5
AR824-1/2	5	12-1/4"	25.5	5
AR825-1/2	6	14-1-1/16"	30.8	5
AR826-1/2	7	15-7/8"	36.1	5
AR827-1/2	8	17-11/16"	41.1	5
AR828-1/2	9	19-1/2"	46.4	5

Device Covers For Gang Boxes Raised 5/8"



AMMO#	#GANGS	DIMENSION	CU IN	PKG
AR821-5/8	2	6-13/16"	9.1	5
AR822-5/8	3	8-5/8"	14.9	5
AR823-5/8	4	10-7/16"	21.0	5
AR824-5/8	5	12-1/4"	25.5	5
AR825-5/8	6	14-1-1/16"	30.8	5
AR826-5/8	7	15-7/8"	36.1	5
AR827-5/8	8	17-11/16"	41.1	5
AR828-5/8	9	19-1/2"	46.4	5

Device Covers For Gang Boxes Raised 3/4"



AMMO#	#GANGS	DIMENSION	CU IN	PKG
AR821	2	6-13/16"	9.1	5
AR822	3	8-5/8"	14.9	5
AR823	4	10-7/16"	21.0	5
AR824	5	12-1/4"	25.5	5
AR825	6	14-1-1/16"	30.8	5
AR826	7	15-7/8"	36.1	5
AR827	8	17-11/16"	41.1	5
AR828	9	19-1/2"	46.4	5

Device Covers For Gang Boxes Raised 1"



AMMO#	#GANGS	DIMENSION	CU IN	PKG
AR821-1	2	6-13/16"	9.1	5
AR822-1	3	8-5/8"	14.9	5
AR823-1	4	10-7/16"	21.0	5
AR824-1	5	12-1/4"	25.5	5
AR825-1	6	14-1-1/16"	30.8	5
AR826-1	7	15-7/8"	36.1	5
AR827-1	8	17-11/16"	41.1	5
AR828-1	9	19-1/2"	46.4	5

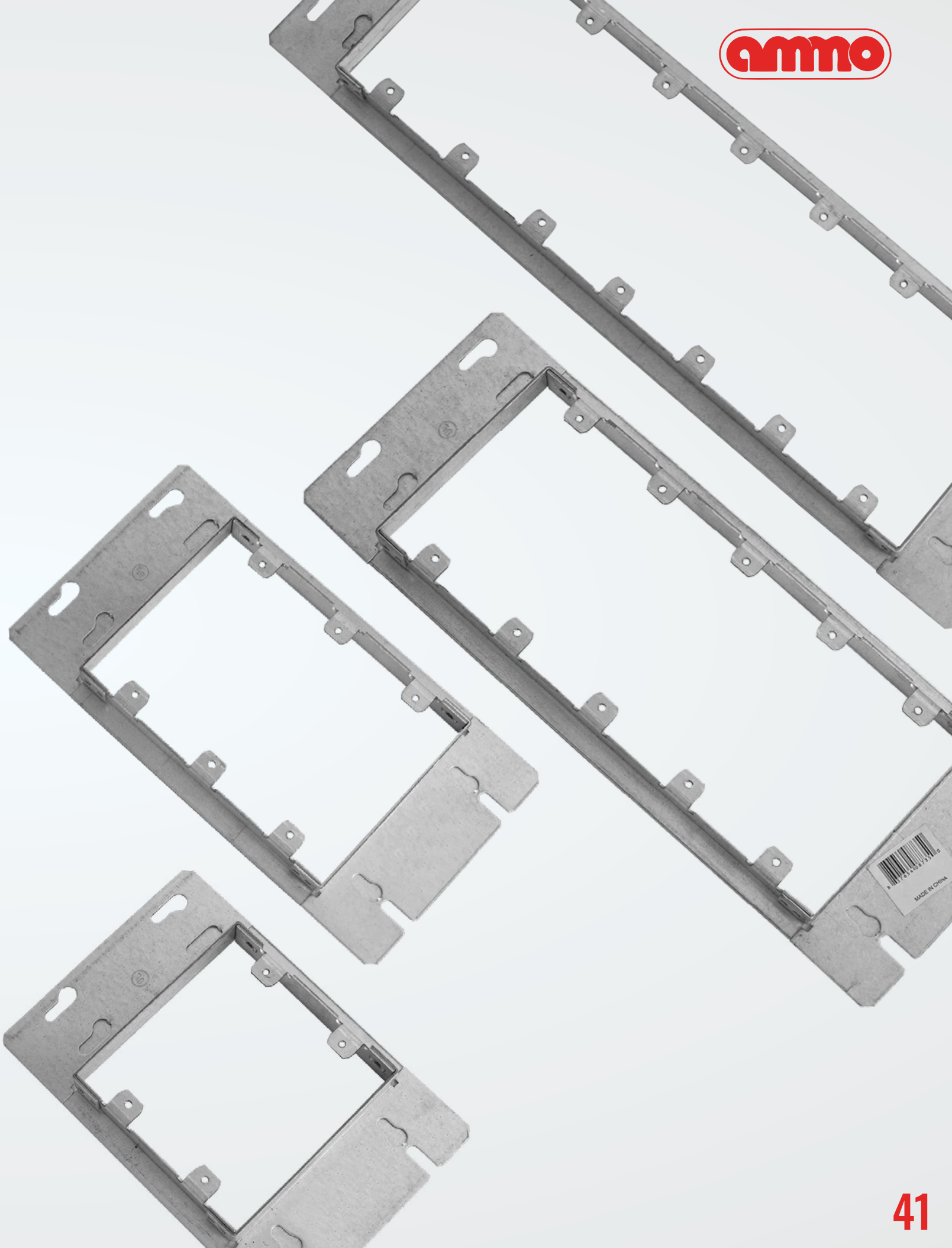

Multi Gang Box Covers Flat Blank



Covers are used to close an outlet box.

AMMO#	#GANGS	DESCRIPTION	FOR USE WITH	INNER	MASTER
AR844	2	Flat, Blank	941 or 951	5	20
AR845	3	Flat, Blank	942 or 952	5	20
AR846	4	Flat, Blank	943 or 953	5	20
AR847	5	Flat, Blank	944 or 954	1	10
AR848	6	Flat, Blank	945 or 955	1	10
AR849	7	Flat, Blank	945 or 956	1	10
AR850	8	Flat, Blank	945 or 957	1	10
AR851	9	Flat, Blank	945 or 958	1	10

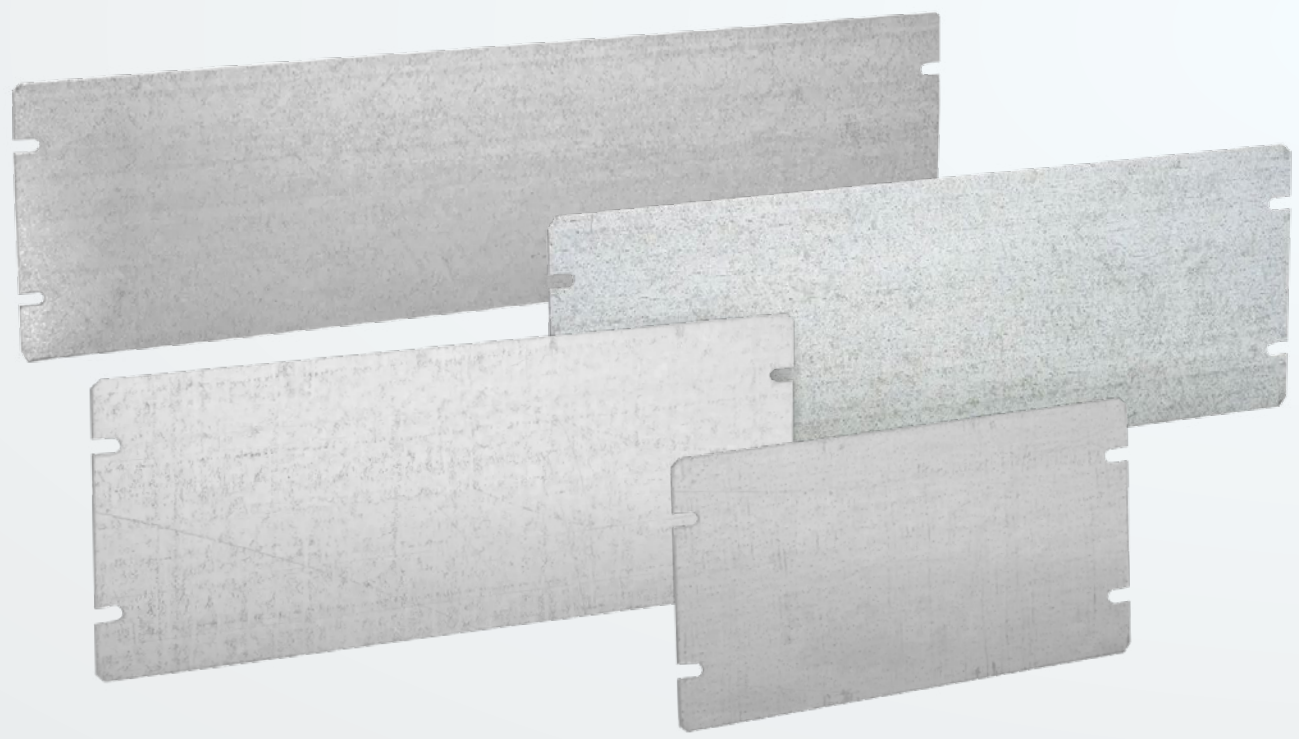

Masonry Boxes 2-1/2" Deep Welded



Masonry Boxes are manufactured from durable pre-galvanized steel, designed to house and protect electrical wiring.



AMMO#	#GANGS	END KO	SIDE KO	BOTTOM KO	FOR USE WITH	PKG
AR688	1	4 EKO	2 EKO	2 EKO	16.0	25
AR695	1	4 EKO	4 EKO	2 EKO	22.5	25
AR691	2	4 EKO	4 EKO	4 EKO	31.8	25
AR696	2	4 EKO	8 EKO	4 EKO	45.0	10
AR692	3	4 EKO	6 EKO	6 EKO	47.8	10
AR693	4	4 EKO	8 EKO	8 EKO	63.5	10
AR694	5	4 EKO	10 EKO	10 EKO	79.5	10
AR960	6	4 EKO	12 EKO	12 EKO	95.3	1



AR688

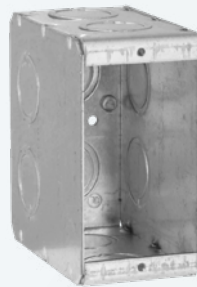

AR695



AR691

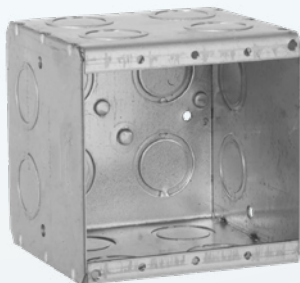

AR696

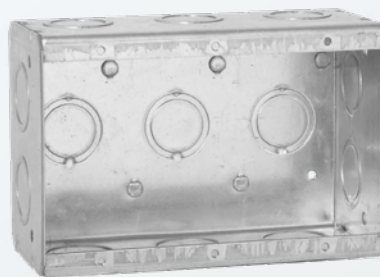

AR692

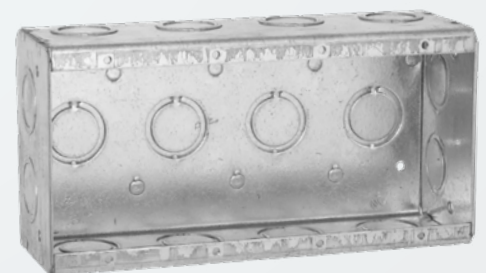

AR693

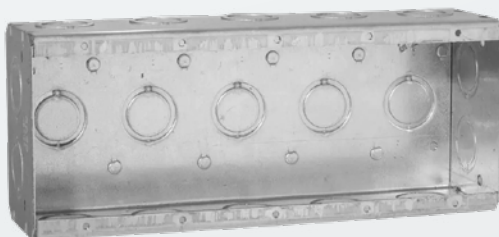

AR694



AR960

Multi-Device Switch Boxes 2-1/2" Deep Welded



Multi device switch boxes used to install multiple devices in one box location.

AMMO#	SIDE KO	END KO	BOTTOM KO	BRACKET, SETBACK	CU IN	PKG
AR686	8-EKO	2-EKO	6-EKO	3-Gang, FB BRKT	47.8	20
AR687	10-EKO	2-EKO	8-EKO	4-Gang, FB BRKT	63.5	20
ARY8MSB-5-FB	10-EKO	2-EKO	10-EKO	5-Gang, FB BRKT	79.6	10

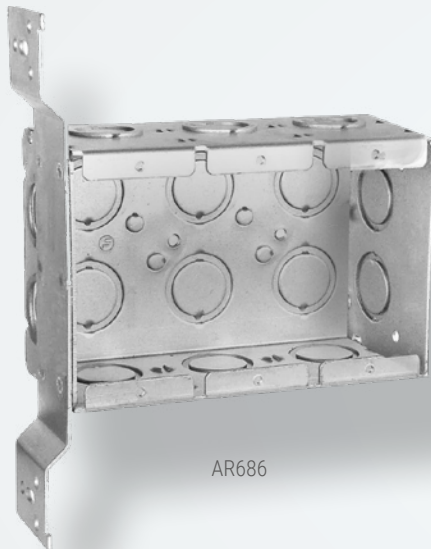

AR686



AR687



ARY8MSB-5-FB

4" Octagon Concrete Rings

Concrete rings are designed to house and protect electrical wiring and to support light fixtures.

AMMO#	DEPTH	BOTTOM KO	KO ROWS	CU IN	PKG
AR270	2"	1/2" & 3/4"	Single	24.5	25
AR271	2-1/2"	1/2" & 3/4"	Single	30.8	25
AR272	3"	1/2" & 3/4"	Single	37.0	25
AR273	3-1/2"	1/2" & 3/4"	Double	43.0	20
AR274	4"	1/2" & 3/4"	Double	49.3	20
AR275	5"	1/2" & 3/4"	Double	61.5	10
AR276	6"	1/2" & 3/4"	Double	74.0	10
AR277	3"	3/4" & 1"	Single	37.0	25
AR278	3-1/2"	3/4" & 1"	Single	43.0	20
AR279	4"	3/4" & 1"	Double	49.3	20

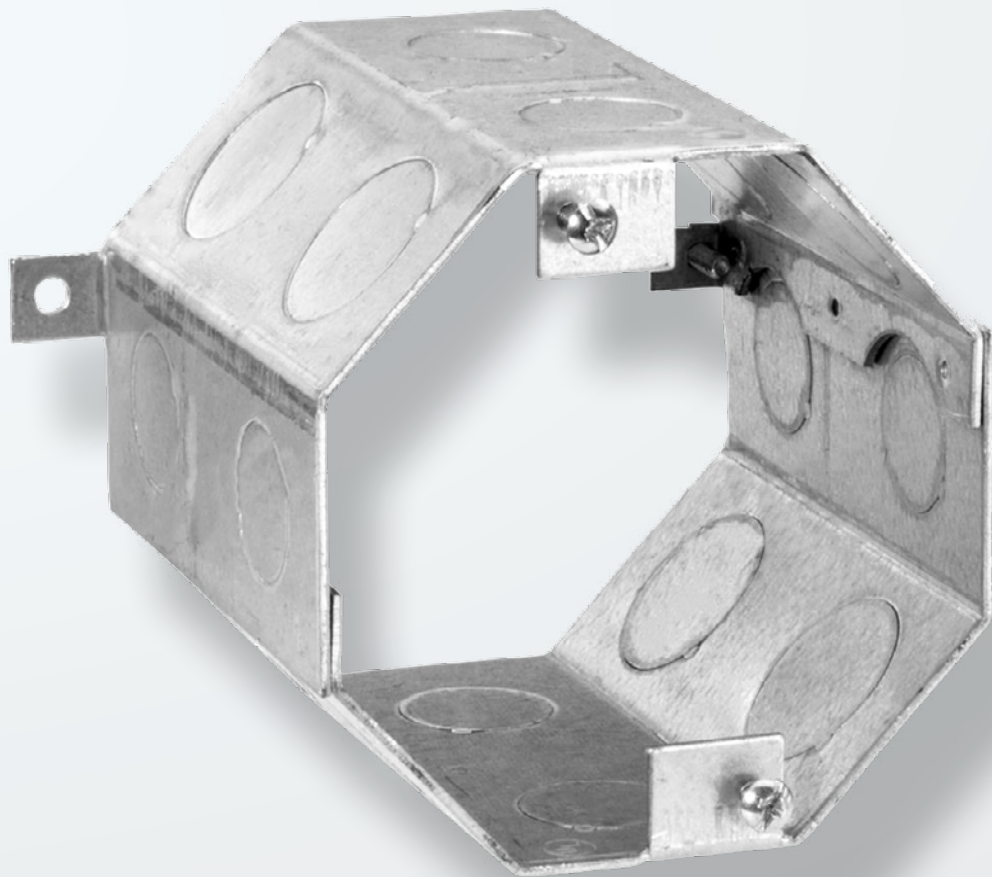

Concrete Ring Covers

Handy Box covers are used to close a Handy Box

AMMO#	DESCRIPTION	KNOCKOUTS	O.D.DIAM	PKG
AR890	Concrete Ring Cover	(3)1/2", (2)3/4"	4-1/2"	50
AR892	Flat, Blank	-	4-1/2"	50
AR891	3/8", Stud	(2)1/2", (2)3/4"	4-1/2"	50

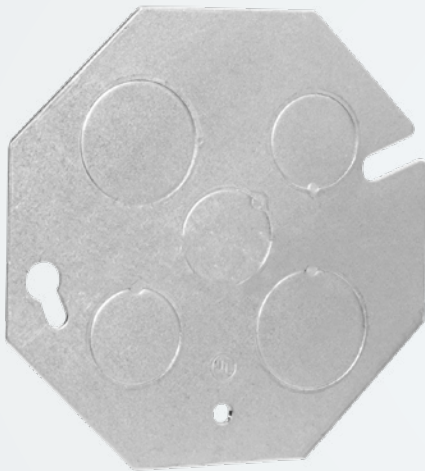

AR890

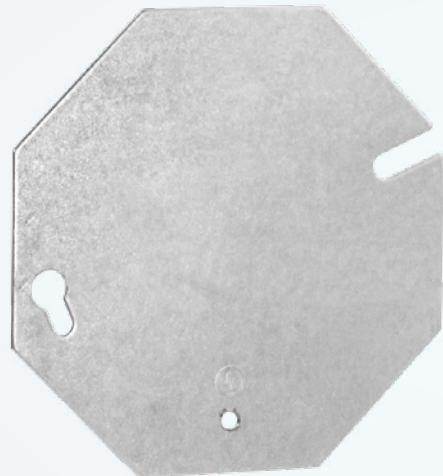

AR892

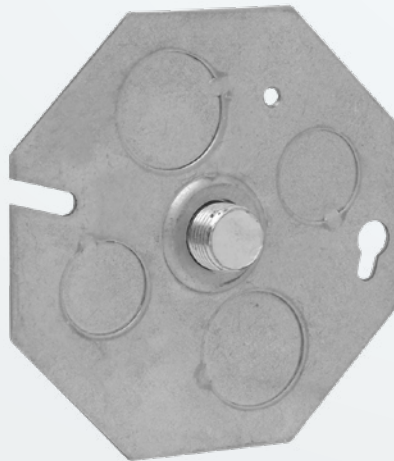

AR891

4 X 2" Handy Boxes

1-7/8" Deep
13.0 Cu In Drawn



AMMO#	SIDE KO	END KO	BOTTOM KO	BRACKET, SETBACK	PKG
AR665	6-1/2"	2-1/2"	-	-	50
AR660	6-1/2"	2-1/2"	2-1/2"	-	50
ARDHB-1-50/75	4-1/2",2-3/4"	2-3/4"	2-1/2" & 1-3/4"	-	50
AR663	4-3/4"	2-3/4"	2-3/4"	-	50
AR661	2-1/2",3-Mko		2-1/2",1-Mko	Ab, 9/16"	50
AR662	3-1/2"	2-1/2"	3-1/2"	Ts Brkt,1/2"	50

 Handy boxes are typically used to install electrical outlets or switches on exposed surfaces.



AR665



AR660



ARDHB-1-50/75



AR663



AR661



AR662

4 X 2" Handy Boxes 16.5" Cu In 1-1/2" Deep



Handy boxes are typically used to install electrical outlets or switches on exposed surfaces.

AMMO#	SIDE KO	BOTTOM KO	DEEP	PKG
AR670	(8)1/2"	(3)1/2"	16.5	50
AR674	(6)3/4"	(2)3/4"	16.5	50
AR650	(8)1/2"	(3)1/2"	1-1/2"	50
AR653	(8)1/2"	-	1-1/2"	50



AR670



AR674

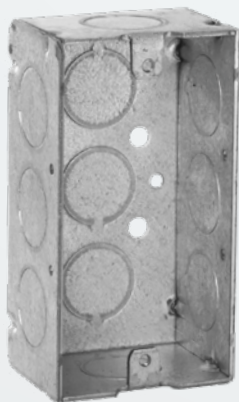

AR650



AR653

4 X 2" Handy Box Covers 2-5/16" Wide 4-3/16" Length



Handy Box covers are used to close a Handy Box, covers may also be used as single-gang wall plates

AMMO#	DESCRIPTION	PKG
AR860	Blank	100
AR861	1/2" KO In Center	100
AR862	GFCI/Decorator	100
AR865	1 Toggle Switch	100
AR864	1 Duplex Receptacle	100
AR863	Single Receptacle, 15a, 1.407" Dia	100
AR867	Power Outlet, 20a & 30a, 1.6" Dia	100

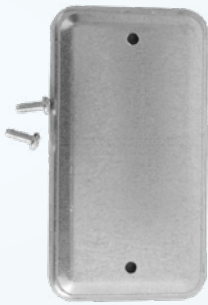

AR860



AR861



AR865



AR862



AR864



AR863



AR867



3 X 2" Switch Boxes 1" Deep 6.5 Cu In



AMMO#	END KO	BRACKET, SETBACK	PKG
AR404	4 cables	Q Clamps, 1/4"	50
AR405	4 cables	Q Clamps, 1/4", NM Cable Clamps	50



3 X 2" Switch Boxes 1-1/2" Deep 7.5 Cu In

Switch boxes are used to house wiring devices such as switches and outlets



AMMO#	END KO	BOTTOM KO	BRACKET, SETBACK	PKG
AR400	(2)1/2"	(1)1/2"	Ears	50
AR410	4 Cables	-	Ears, NM Cable Clamps	50
AR411	4 Cables	(1)1/2"	Ears, BX/MC Cable Clamps	50
AR150-DSWB	-	(1)1/2"	Cable Clamps	50

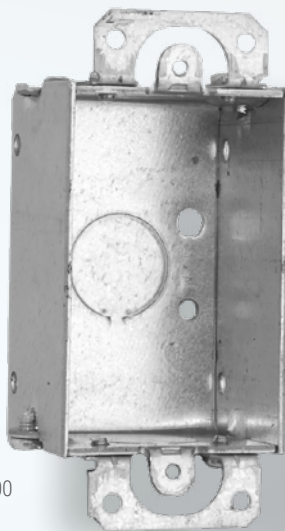

AR400

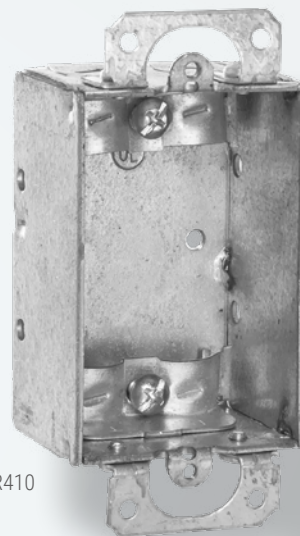

AR410

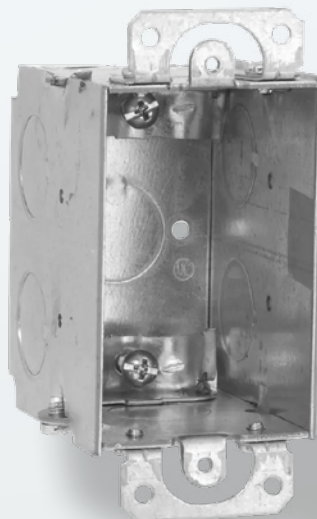

AR411

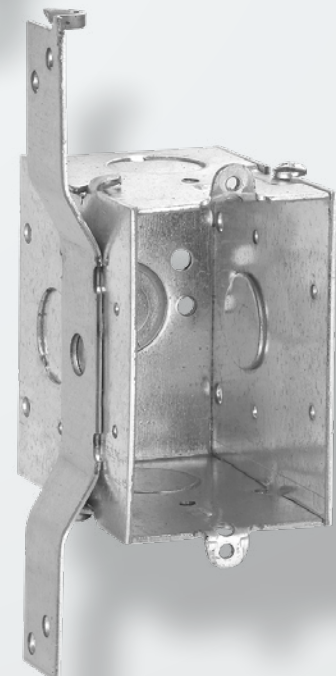

AR150-DSWB



3 X 2" Switch Boxes 2" Deep 10.0 Cu In



AMMO#	SIDE KO	END KO	BOTTOM KO	BRACKET, SETBACK	PKG
AR420	(4)1/2"	(2)1/2"	(2)1/2"	Ears	50
AR440	-	4 Cables	(1)1/2"	Ears, BX/MC Cable Clamps	50
AR445	-	4 Cables	(1)1/2"	Ears, NM Cable Clamps	50



AR420

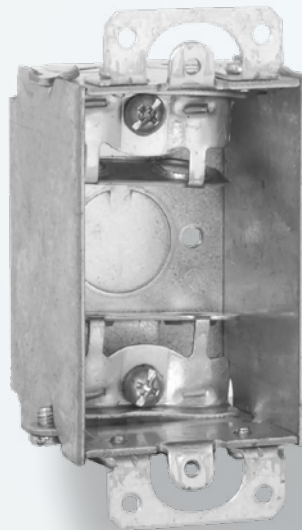

AR440

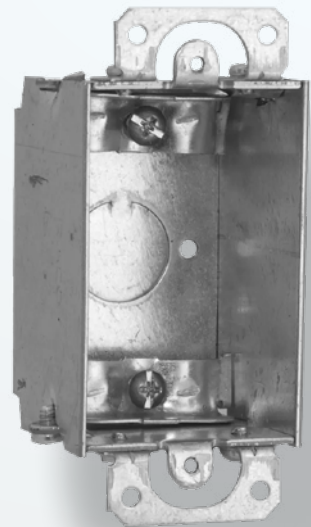

AR445

ELECTRICAL BOXES & COVERS

3 X 2" Switch Boxes ^{2-1/4" Deep} 10 Cu In



AMMO#	END KO	BOTTOM KO	BRACKET, SETBACK	PKG
AR471	(2)1/2" 4 cables	(1)1/2"	Ears, NM Cable Clamps	50
AR487	(2)1/2" 4 cables	(1)1/2"	Ears, Old Work, NM Cable	50



AR471



AR487

3 X 2" Switch Boxes 2-1/2" Deep 12.5 Cu In



AMMO#	SIDE KO	END KO	BOTTOM KO	BRACKET, SETBACK	PKG
AR523	-	4-Cables	(1)1/2"	Old Work, BX, MC Cable Clamps	50
AR500	(4)1/2"	(2)1/2"	(2)1/2"	Ears	50
AR501	(4)1/2"	(2)1/2"	(2)1/2"	No Bracket	50
AR503	(4)1/2"	(2)3/4"	(2)1/2"	Ears	50
AR509	(4)1/2"	-	-	NMSC Clamps, Plaster Ears	50
AR517	-	-	(1)1/2"	Sheathed Cable Clamps, Plaster Ears, Old Work, Tigergrip	50
AR518	-	4 Cables	(1)1/2"	Ears, BX/MC Cable Clamps	50
AR519	-	4 Cables	(1)1/2"	Ears, NM Cable Clamps	50
AR524	-	4-Cables, (2)1/2"	(1)1/2"	TS BRKT, 1/2" BX, MC Cable Clamps	50
AR531	-	4-Cables	(1)1/2"	TS BRKT 1/2" NM Cable Clamps	50
AR504	(2)1/2"	(2)1/2"	(2)1/2"	TS BRKT, 1/2"	50
AR505	(2)1/2"	(2)3/4"	(2)1/2"	TS BRKT, 1/2"	50
AR502	(4)1/2"	(2)1/2"	(2)1/2"	B BRKT, 5/8	50
AR529	(2)1/2"	4-Cables(2)1/2"	(1)1/2"	B Brk, 5/8" NM Cable Clamps	50
AR522	-	4 Cables, (2)1/2"	(1)1/2"	Long B, 5/8", BX/MC Cable Clamps	50
AR250-DEX	-	-	-	Switch Box Extender	50



AR523



AR500



AR501



AR503

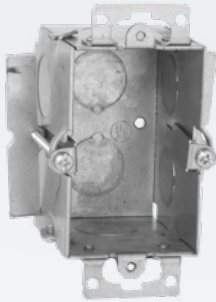

AR509

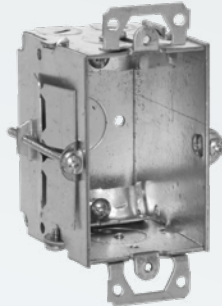

AR517

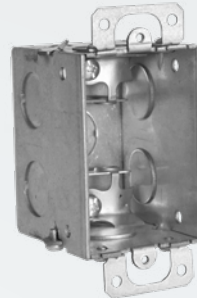

AR518



AR519

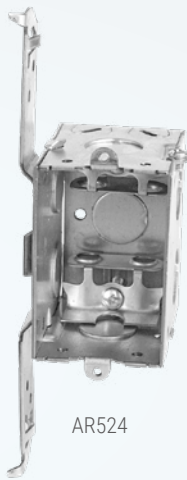

AR524



AR531

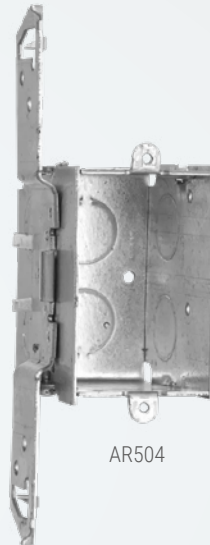

AR504

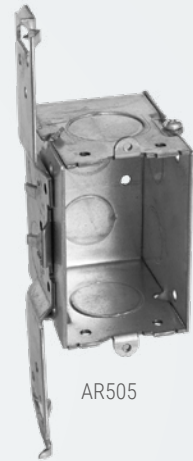

AR505

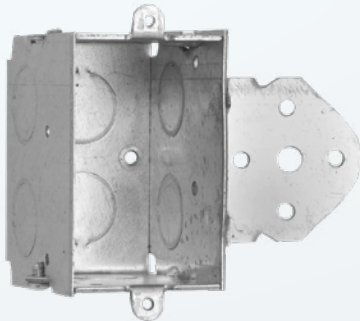

AR502

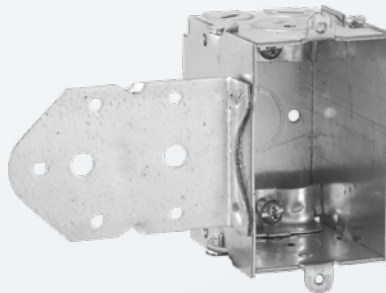

AR529

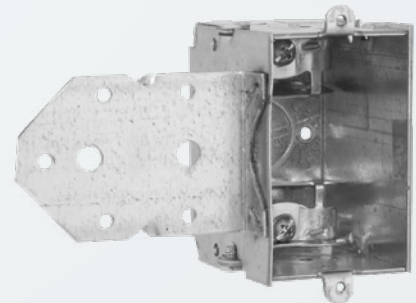

AR522



AR250-DEX

3 X 2" Switch Boxes 2-3/4" Deep 14.0 Cu In



 Switch boxes are used to house wiring devices such as switches and outlets

AMMO#	SIDE KO	END KO	BOTTOM KO	BRACKET, SETBACK	PKG
AR560	(4)1/2"	(2)1/2"	(2)1/2"	Ears	50
AR561	(4)1/2"	(2)1/2"	(2)1/2"	No Bracket	50
AR562	(2)1/2"	(2)1/2"	(2)1/2"	TS BRKT, 1/2"	50
AR564	(2)1/2"	4 Cables, (2)1/2"	-	TS BRKT, 1/2" NM Cable Clamps	50
AR565	(2)1/2"	-	-	Ears	50
AR567	(4)1/2"	4 Cables, (2)1/2"	(1)1/2"	Ears, NM Cable Clamps	50
AR570	(4)1/2"	4 Cables, (2)1/2"	(1)1/2"	Ears, BX/MC Cable Clamps	50
AR574	(2)1/2"	4 Cables, (2)1/2"	(2)1/2"	TS Brkct, BX/MC Cable Clamps	50

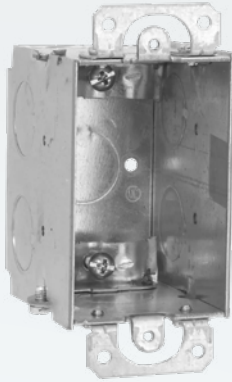

AR567

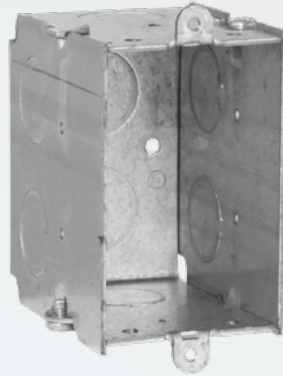

AR561

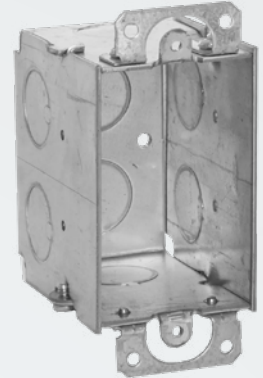

AR560

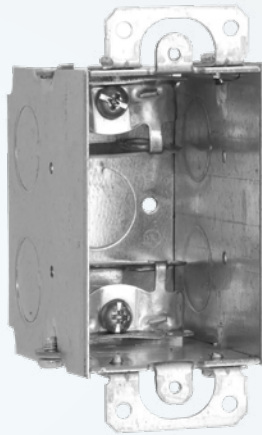

AR570



AR565

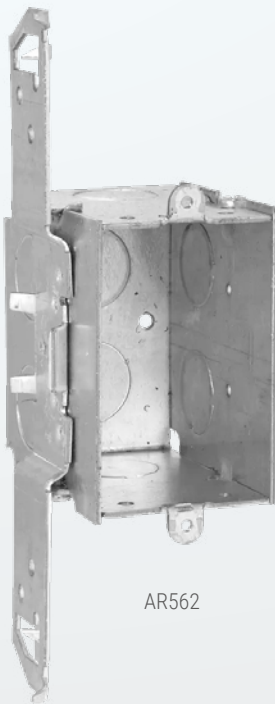

AR562

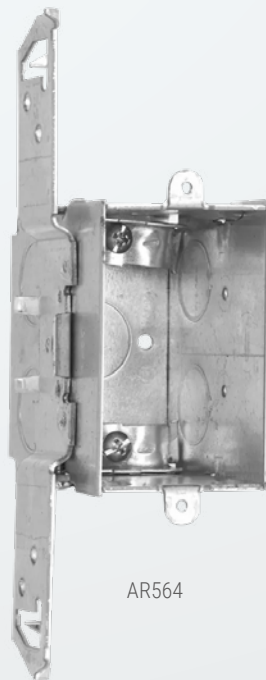

AR564

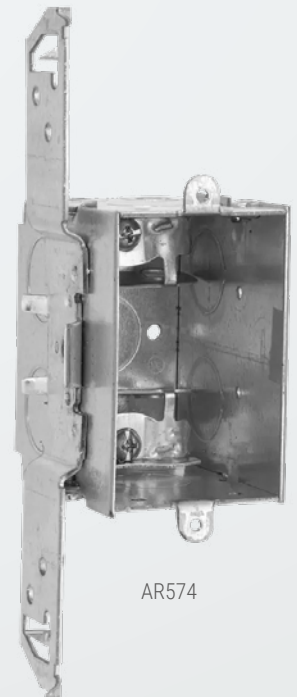

AR574



3 X 2" Switch Boxes 3-1/2" Deep 18.0 Cu In



 Switch boxes are used to house wiring devices such as switches and outlets

AMMO#	SIDE KO	END KO	BOTTOM KO	BRACKET, SETBACK	PKG
AR590	(4)1/2"	(4)1/2"	(1)1/2"	Ears	50
AR591	(4)3/4"	(4)3/4"	(1)3/4"	Ears	50
AR592	(4)1/2"	(4)1/2"	(1)1/2"	No Bracket	50
AR600	(4)1/2"	4 Cables, (2)1/2"	(1)1/2"	Ears, BX/MC Cable Clamps	50
AR601	(4)1/2"	4 Cables, (2)1/2"	(1)1/2"	Ears, NM, Cable Clamps	50
AR603	(4)1/2"	4 Cables, (2)1/2"	(1)1/2"	B BRKT, 5/8", NM Cable Clamps	50
AR604	(4)1/2"	4 Cables, (2)1/2"	(1)1/2"	TS BRKT, 1/2", BX/MC NM Cable Clamps	50
AR605	(4)1/2"	4 Cables, (2)1/2"	(1)1/2"	TS BRKT, 1/2", NM Cable Clamps	50

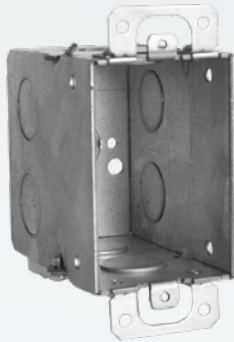

AR590

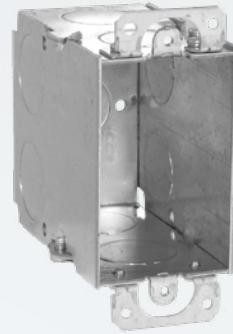

AR591

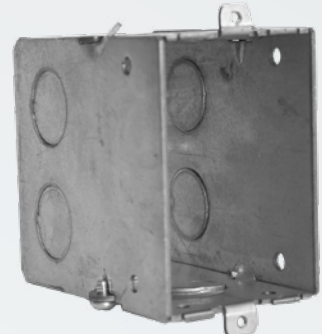

AR592

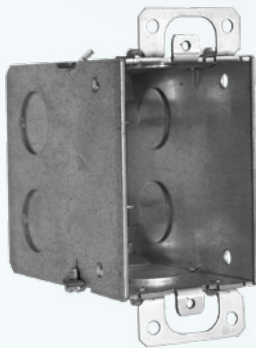

AR600

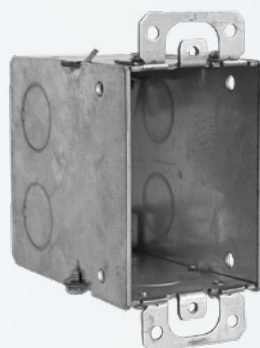

AR601

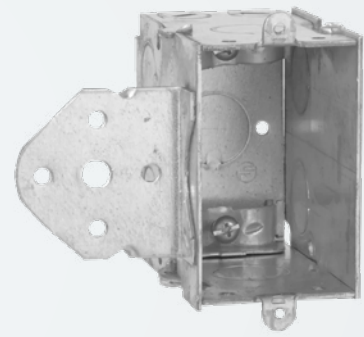

AR603

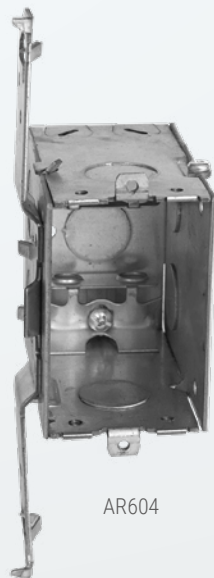

AR604

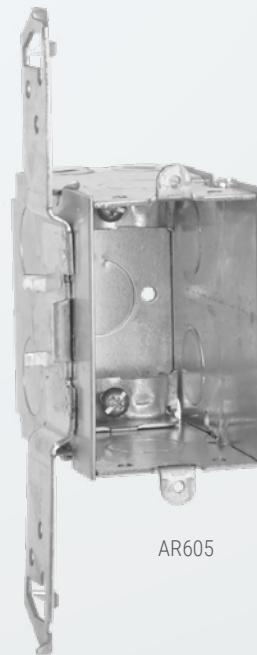

AR605



Add-A-Depth Ring



Long Screws Included



AMMO#	DESCRIPTION	PKG
AR976	3" X 2" Add-A-Depth Ring With (2) 1 1/8" Long Screws Included	25

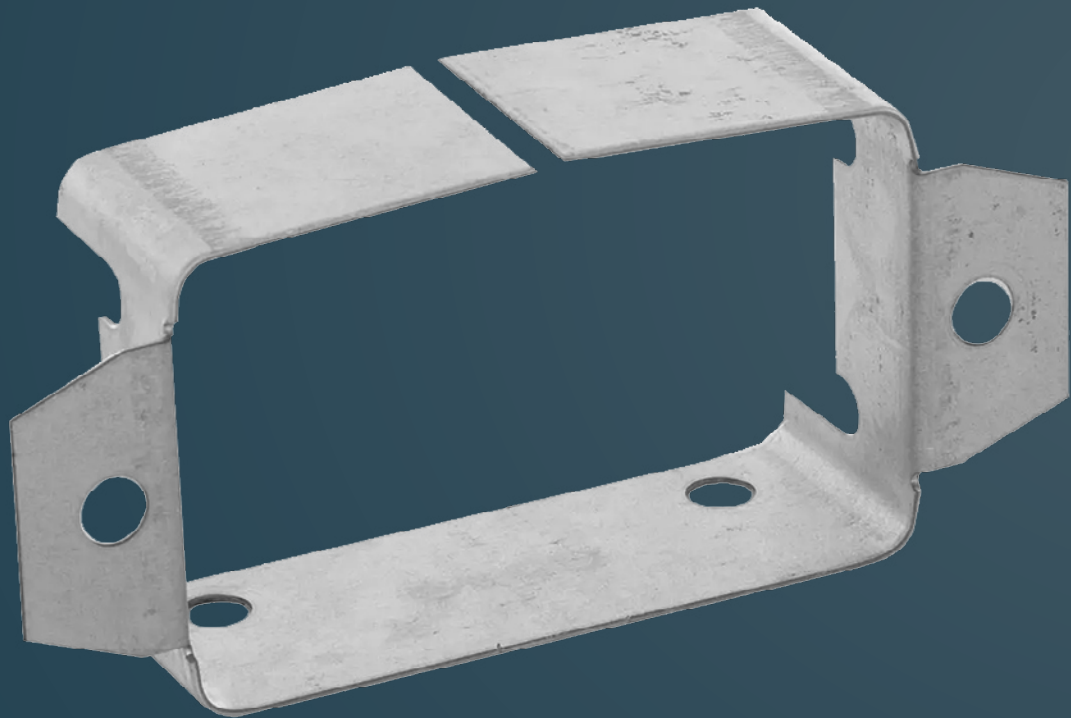

ELECTRICAL BOXES & COVERS

Blank Covers



AMMO#	DESCRIPTION	COLOR	PKG
AR1BC	1-Gang	Steel-Aluminum	100
AR2BC	2-Gang	Steel-Aluminum	50
AR3BC	3-Gang	Steel-Aluminum	50
ARRBC-4	4" Round	Steel-Aluminum	100

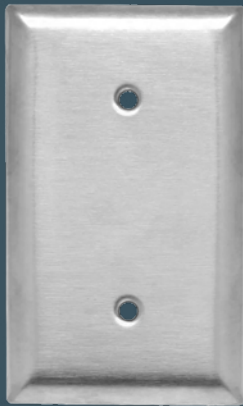

AR1BC

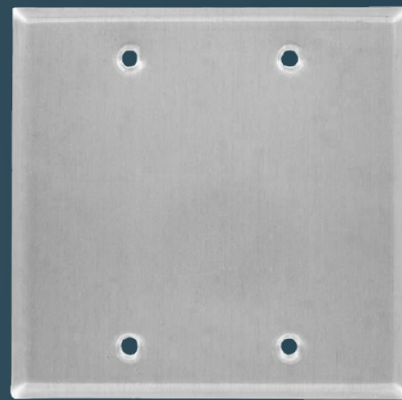

AR2BC



AR3BC

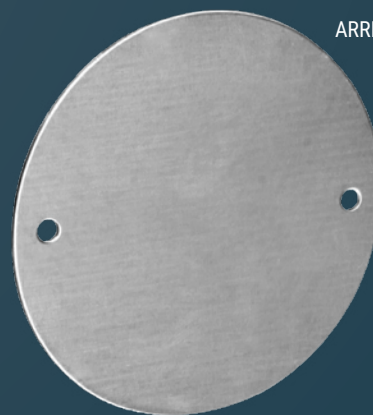

ARRBC-4

Reducing Washers

Designed to reduce the size of the knockout in a steel outlet box or other metal enclosure



AMMO#	SIZE	INNER	MASTER
ARRW7550	3/4" x 1/2"	100	1000
ARRW10050	1" x 1/2"	100	1000
ARRW10075	1" x 3/4"	100	1000
ARRW12550	1-1/4" x 1/2"	50	500
ARRW12575	1-1/4" x 3/4"	50	500
ARRW125100	1-1/4" x 1"	50	500
ARRW15050	1-1/2" x 1/2"	50	500
ARRW15075	1-1/2" x 3/4"	50	500
ARRW150100	1-1/2" x 1"	50	500
ARRW150125	1-1/2" x 1-1/4"	50	500
ARRW20050	2" x 1/2"	25	250
ARRW20075	2" x 3/4"	25	250
ARRW200100	2" x 1"	25	250
ARRW200125	2" x 1-1/4"	25	250
ARRW200150	2" x 1-1/2"	25	250
ARRW25050	2-1/2" x 1/2"	25	250
ARRW25075	2-1/2" x 3/4"	25	250
ARRW250100	2-1/2" x 1"	25	250
ARRW250125	2-1/2" x 1-1/4"	25	250
ARRW250150	2-1/2" x 1-1/2"	25	250
ARRW250200	2-1/2" x 2"	25	250
ARRW30050	3" x 1/2"	25	250
ARRW30075	3" x 3/4"	25	250

AMMO#	SIZE	INNER	MASTER
ARRW300100	3" x 1"	25	250
ARRW300125	3" x 1-1/4"	25	250
ARRW300150	3" x 1-1/2"	25	250
ARRW300200	3" x 2"	25	250
ARRW300250	3" x 2-1/2"	25	250
ARRW35050	3-1/2" x 1/2"	10	100
ARRW35075	3-1/2" x 3/4"	10	100
ARRW350100	3-1/2" x 1"	10	100
ARRW350125	3-1/2" x 1-1/4"	10	100
ARRW350150	3-1/2" x 1-1/2"	10	100
ARRW350200	3-1/2" x 2"	10	100
ARRW350250	3-1/2" x 2-1/2"	10	100
ARRW350300	3-1/2" x 3"	10	100
ARRW40050	4" x 1/2"	10	100
ARRW40075	4" x 3/4"	10	100
ARRW400100	4" x 1"	10	100
ARRW400125	4" x 1-1/4"	10	100
ARRW400150	4" x 1-1/2"	10	100
ARRW400200	4" x 2"	10	100
ARRW400250	4" x 2-1/2"	10	100
ARRW400300	4" x 3"	10	100
ARRW400350	4" x 3-1/2"	10	100



Nail Safety Plates



Nail Safety Plates are installed on wood studs and structural members to prevent screws and nails from penetrating and damaging wiring and pipes.

AMMO#	FEATURES	DIMENSION (W x H)	THICK	PKG
ARSP-1	With 2 Mounting Prongs & 1 Nail Hole Each End	1.5" X 2.75"	16ga	100
ARSP-6	With 2 Mounting Prongs & 1 Nail Hole Each End	1.5" X 6"	16ga	100
ARSP-35	With 2 Mounting Prongs & 1 Nail Hole Each End	3" X 5"	16ga	50



Nail Drive Straps

#AMMO	FEATURES	DIMENSION	PKG
ARDRS-50	Flat Type Drive Strap	1/2"	100
ARDRS-75	Flat Type Drive Strap	3/4"	100
ARDRS-100	Flat Type Drive Strap	1"	100



Steel Knockout Seals-Snap In



 *Designed to cover exposed knockout holes in steel outlet boxes and other metal enclosures*

AMMO#	SIZE	INNER	MASTER
ARKO-50	1/2"	100	1000
ARKO-75	3/4"	100	1000
ARKO-100	1"	50	500
ARKO-125	1-1/4"	50	500
ARKO-150	1-1/2"	50	500
ARKO-200	2"	10	100



Steel Knockout Seals-Three Piece



 *Designed to cover exposed knockout holes in steel outlet boxes and other metal enclosures*

AMMO#	SIZE	PKG
ARKOS-250	2-1/2"	50
ARKOS-300	3"	50
ARKOS-350	3-1/2"	50
ARKOS-400	4"	50



PVC New Work Boxes



Designed for use with non-metallic sheathed cable. Great for residential and light commercial applications, the box is made with polycarbonate, is listed for use with masonry walls and can be used with 90 degree conductors.

AMMO#	SIZE	STYLE	FINISH	INSTALLATION METHOD	GANG	PKG
ARB18A	2-7/8" D X 2-1/4" W X 3-3/4" L	Modern	Sheathed	Nail-On	One gang	100
ARB22A-UPC	2-7/8" D X 2-1/4" W X 3-3/4" L	Modern	Sheathed	Nail-On	One gang	100
AR121ADJ	3.65" X 2.25" X 3.32"	Modern	Sheathed	Nail-On	One gang	50
ARB32A-UPC	3" D X 4" W X 3 3/4"	Modern	Sheathed	Nail-On	Two gang	60
ARB20P-UPC	4" X 2-1/4" Deep	Modern	Sheathed	Nail-On	-	100
ARB20A-UPC	4" X 2-1/4" Deep	Modern	Sheathed	Nail-On	-	100

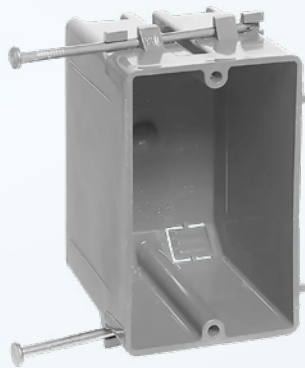

ARB18A

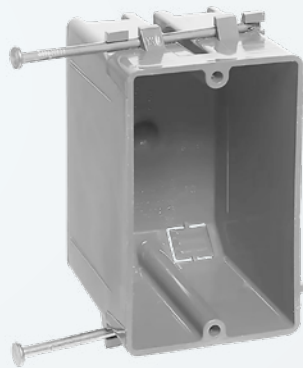

ARB22A-UPC

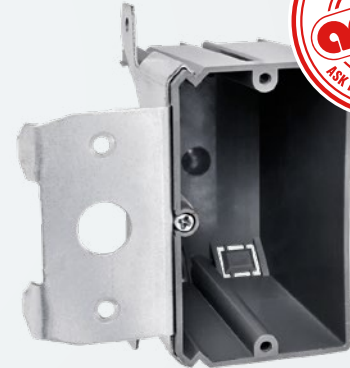

AR121ADJ

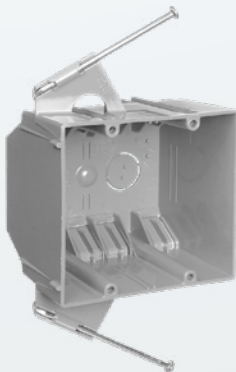

ARB32A-UPC

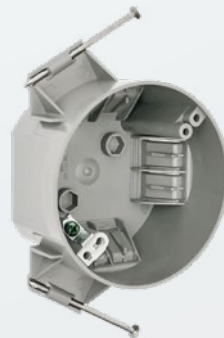

ARB20P-UPC

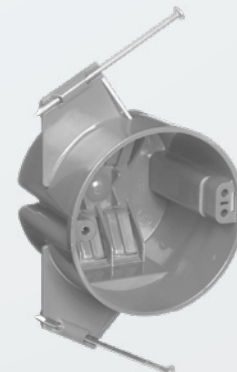

ARB20A-UPC

PVC New Work Boxes

AMMO#	SIZE	STYLE	FINISH	INSTALLATION METOD	#GANG	INNER	MASTER
AR455HB	2.59" D X 3.70" W X 10.8-15.3" L	Sheathed	Adjustable Bracket	Nail-On	Four gang	1	25
ARB44AB	3" D X 4" W X 3-3/4" L	Modern	Sheathed	Nail-On	Three gang		30
ARB64A	3" D X 4" W X 3-3/4" L	Modern	Sheathed	Nail-On	Four gang		30
ARB53A	2-7/8" D X 2-1/4" W X 3-3/4" L	Modern	Sheathed	Nail-On	Three gang		30
ARB55A-UPC	2-1/2" D X 3-7/10" W X 7-3/5" L	Modern	Sheathed	Nail-On	Four gang		30
ARB525A	4" diameter and depth 2-1/4"	Sheathed	Telescopic Bracket	-	-		75

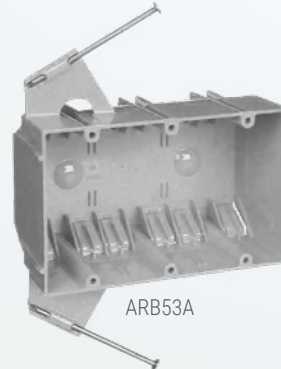
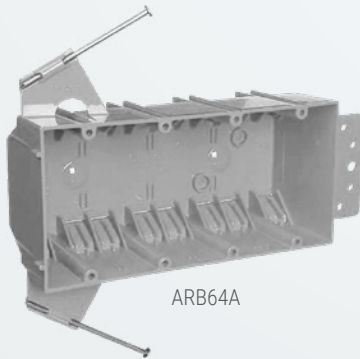
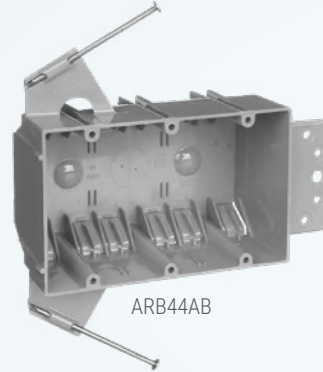

PVC Old Work Boxes

AMMO#	DESCRIPTION	PKG
ARB108R	One-Gang Shallow Box 8 CU.IN Mounting Ears 1 1/4"D X 2 3/8"W X 35/8"L	200
ARB120R	One-Gang Box 20 CU.IN Mounting Ears and Swing Bracket 35/8"D x 25/16" x 41/8"L	100
ARB618R	Round Old Work Box 18 CU.IN Swing Clamps 4-1/4"DIA.	75



ARB108R

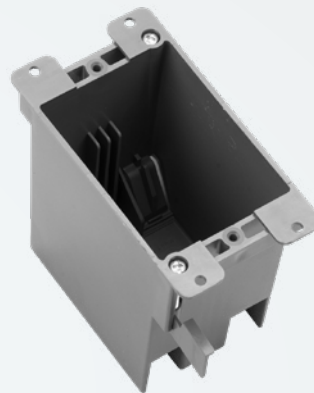

ARB120R

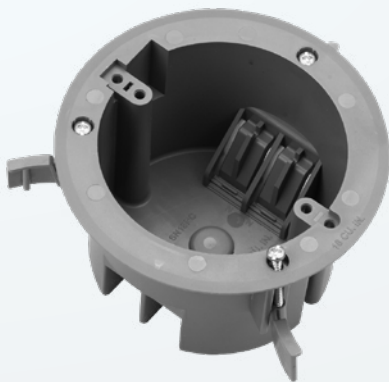

ARB618R



Plastic Extension Rings



AMMO#	DESCRIPTION	INNER	MASTER
AR-PR1	1 Gang Extension Ring, Plastic	25	250
AR-PR2	2 Gang Extension Ring, Plastic	25	250
AR-PR3	3 Gang Extension Ring, Plastic	10	100
AR-PR4	4 Gang Extension Ring, Plastic	10	100
AR-PR5	Octagon Extension Ring, Plastic	10	100

AR-PR1



AR-PR2

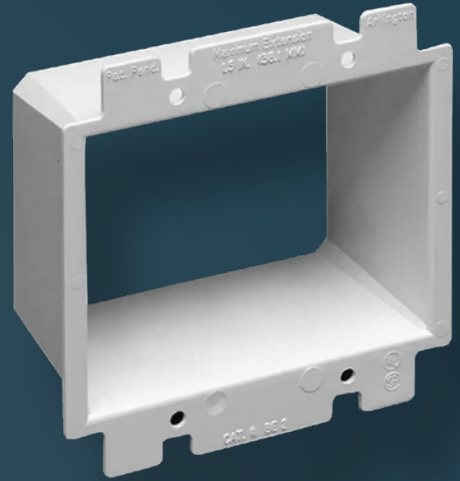

AR-PR3

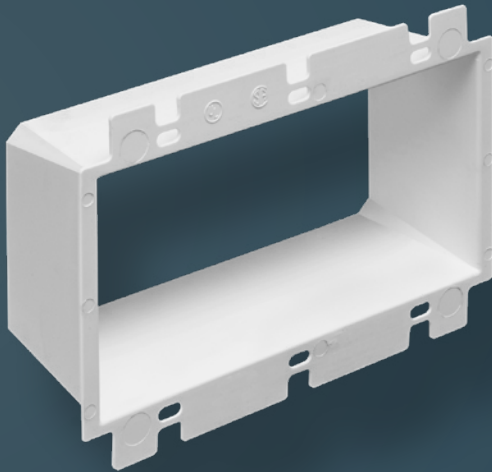

AR-PR4

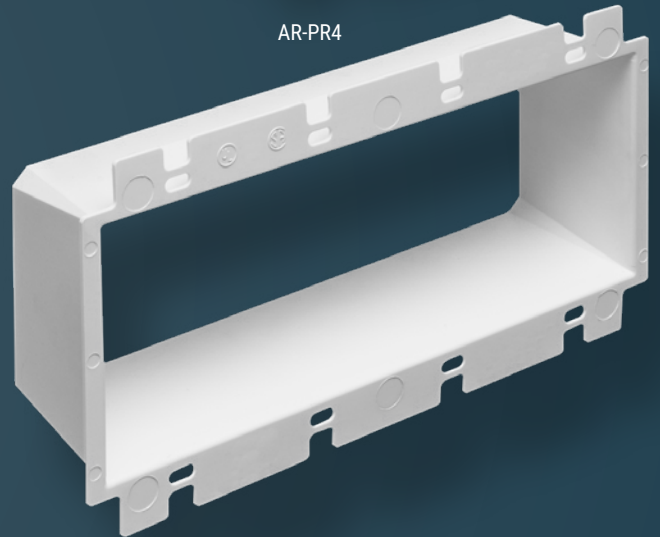

AR-PR5

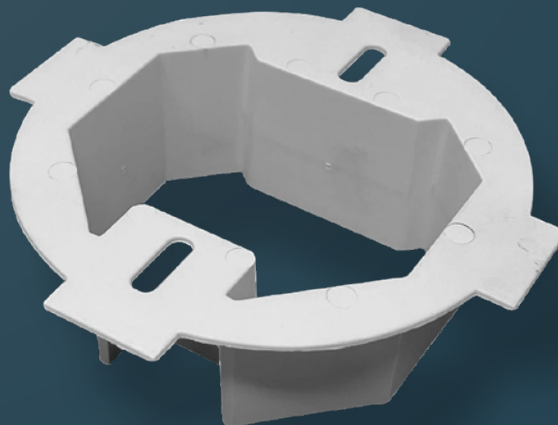

One Gang Weatherproof Boxes _____	72
Weatherproof Extension Single Gang _____	74
Two Gang Weatherproof Boxes _____	75
Closure Plug _____	78
Three Gang Weatherproof Box _____	79
One Gang Weatherproof Covers _____	80
Two Gang Weatherproof Covers _____	82
Three Gang Weatherproof Covers _____	82
In-Use Covers _____	83
Round Weatherproof Boxes _____	84
Lampholders _____	85
Lampholder Covers _____	86
Vapor Tight Light Fixtures _____	87
Service Entrance Caps _____	88

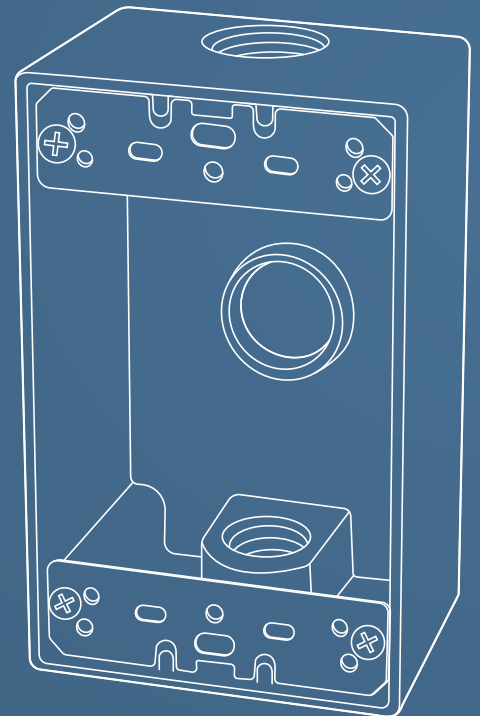
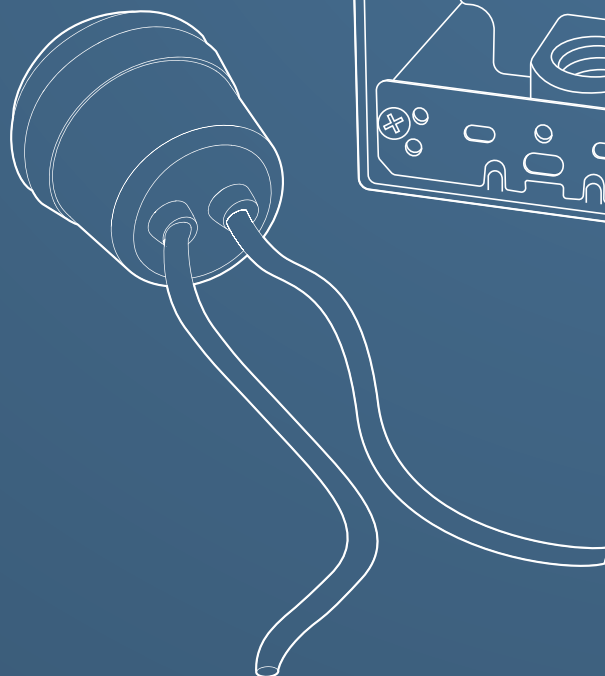
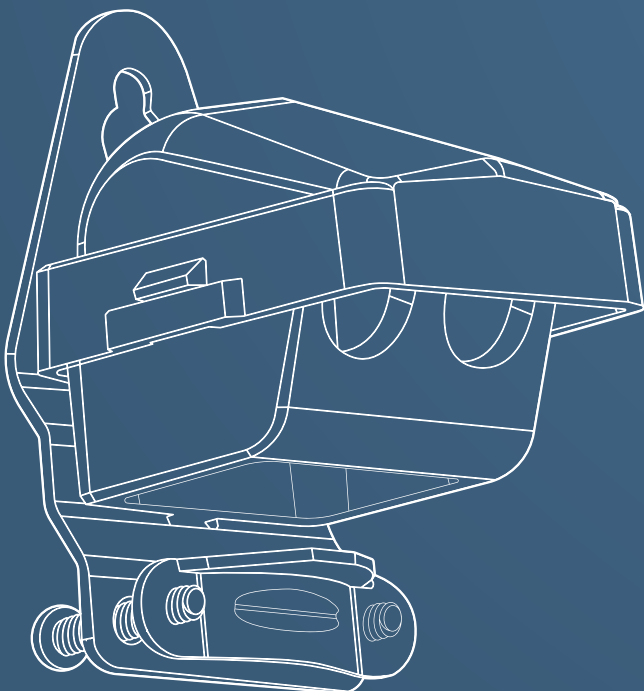

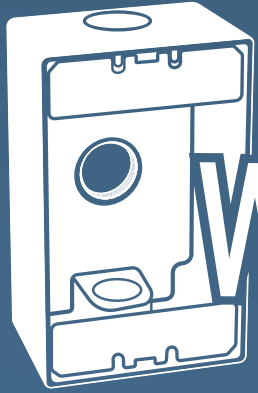

WEATHERPROOF



One Gang Weatherproof Boxes, 2" Deep, White and Gray



 Weatherproof boxes are durable enclosures designed to protect electrical components from harsh weather conditions. Constructed in plastic, these boxes feature tight seals and gaskets to prevent water and moisture ingress

AMMO#	HOLES	SIZE	PLUGS	COLOR	CU IN	PKG
ARFSB50-3	3	1/2"	3	Gray	18.3	50
ARFSB50-3-W	3	1/2"	3	White	18.3	50
ARFSB50-4	4	1/2"	4	Gray	17.0	50
ARFSB50-4-W	4	1/2"	4	White	17.0	50
ARFSB50-5	5	1/2"	5	Gray	15.8	50
ARFSB50-5X	5	1/2"	5	Gray	15.8	50
ARFSB75-3	3	3/4"	3	Gray	18.3	50
ARFSB75-3-W	3	3/4"	3	White	18.3	50
ARFSB75-4	4	3/4"	4	Gray	17.0	50
ARFSB75-4-W	4	3/4"	4	White	17.0	50
ARFSB75-5	5	3/4"	5	Gray	15.8	50
ARFSB75-5X	5	3/4"	5	Gray	15.8	50
ARFSB100-3	3	1"	3	Gray	18.3	50



One Gang Weatherproof Boxes, 2-5/8" Deep, White and Gray



The box is designed for indoor or outdoor use. Finished with premium durable powder-coat paint

AMMO#	HOLES	SIZE	PLUGS	COLOR	CU IN	PKG
ARDB50-3	3	1/2"	3	Gray	23.8	40
ARDB50-4	4	1/2"	4	Gray	23.8	40
ARDB50-5X	5	1/2"	5	Gray	23.8	40
ARDB75-3	3	3/4"	3	Gray	23.8	40
ARDB75-4	4	3/4"	4	Gray	23.8	40
ARDB75-5X	5	3/4"	5	Gray	23.8	40
ARDB100-3	3	1"	3	Gray	23.8	40
ARDB100-5X	5	1"	5	Gray	23.8	40

Weatherproof Extension Rectangle Single Gang

AMMO#	SIZE	DEPTH	PKG
ARWB-1EXT	2.81"X4.56"	1"	50



Two Gang Weatherproof Boxes, 2-5/8" Deep, Gray



 The box is designed for indoor or outdoor use. Finished with premium durable powder-coat paint

AMMO#	HOLES	SIZE	PLUGS	COLOR	CU IN	PKG
ARDBT50-5	5	1/2"	5	Gray	40.5	20
ARDBT75-5	5	3/4"	5	Gray	40.5	20
ARDBT100-5	5	1"	5	Gray	40.5	20
ARDBT50-7X	7	1/2"	7	Gray	40.5	20
ARDBT75-7X	7	3/4"	7	Gray	40.5	20
ARDBT100-7X	7	1"	7	Gray	40.5	20

ARDBT50-5



ARDBT75-5



ARDBT100-5



ARDBT50-7X



ARDBT75-7X



ARDBT100-7X





Two Gang Weatherproof Boxes, 2-3/16" Deep, Gray



AMMO#	HOLES	SIZE	PLUGS	COLOR	CU IN	PKG
ARTGB50-3	3	1/2"	3	Gray	30.5	40
ARTGB50-4	4	1/2"	4	Gray	30.5	40
ARTGB50-5	5	1/2"	5	Gray	30.5	40
ARTGB50-5X	5	1/2"	7	Gray	30.5	40
ARTGB50-7	7	1/2"	7	Gray	30.5	40
ARTGB50-7X	7	1/2"	7	Gray	30.5	40
ARTGB50-9	9	1/2"	9	Gray	30.5	40
ARTGB75-3	3	3/4"	3	Gray	30.5	40
ARTGB75-4	4	3/4"	4	Gray	30.5	40
ARTGB75-5	5	3/4"	5	Gray	30.5	40
ARTGB75-5X	5	3/4"	5	Gray	30.5	40
ARTGB75-7	7	3/4"	7	Gray	30.5	40
ARTGB75-7X	7	3/4"	7	Gray	30.5	40
ARTGB75-9	9	3/4"	9	Gray	30.5	40
ARTGB100-3	3	1"	3	Gray	30.5	40
ARTGB100-4	4	1"	4	Gray	30.5	40
ARTGB100-5X	5	1"	5	Gray	30.5	40

WEATHERPROOF



ARTGB50-3
ARTGB75-3
ARTGB100-3



ARTGB50-4
ARTGB75-4
ARTGB100-4



ARTGB50-7
ARTGB75-7



ARTGB50-7X
ARTGB75-7X



ARTGB50-5
ARTGB75-5



ARTGB50-5X
ARTGB75-5X
ARTGB100-5X



ARTGB50-9
ARTGB75-9

Closure Plug Aluminum



AMMO#	SIZE	INNER	MASTER
ARPT-75	1/2"	100	1000
ARPT-50	3/4"	50	500
ARPT-100	1"	25	250



WEATHERPROOF

Three Gang Weatherproof Box



AMMO#	HOLES	SIZE	COLOR	CU IN	PKG
ARWB-3750	7	1/2"	Gray	54	24
ARWB-3775	7	3/4"	Gray	54	24
ARWB-37100	7	1"	Gray	54	24

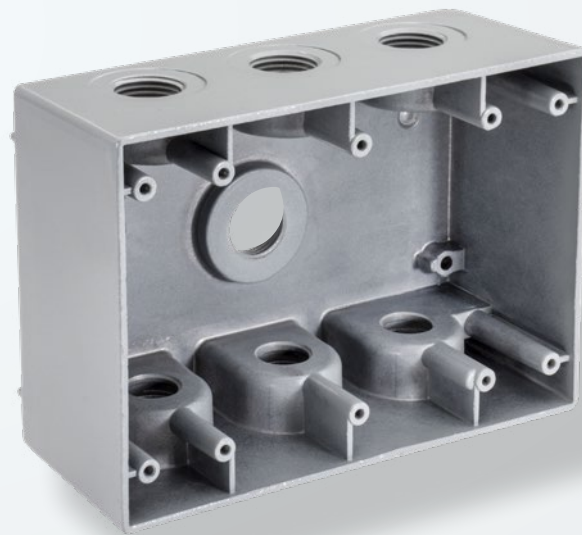



One Gang Weatherproof Covers



AMMO#	DESCRIPTION	COLOR	PKG
ARTS100	Toggle Switch	Gray	50
AR1C-DH	Duplex/Comb.device-Horizontal	Gray	50
AR1C-DH-W	Duplex/Comb.device-Horizontal White	White	50
AR1C-DV	Duplex/Comb.device-Vertical	Gray	50
AR1C-DV-W	Duplex/Comb.device-Vertical White	White	50
AR1C-GH	GFCI-Horizontal	Gray	50
AR1C-GH-W	GFCI-Horizontal White	White	50
AR1C-GV	GFCI-Vertical	Gray	50
AR1C-GV-W	GFCI-Vertical White	White	50
AR1C-SV	S/R Or S/W Vert-1.41" Diameter	Gray	50
AR1C-SV-W	S/R Or S/W Vert-1.41" Diameter White	White	50
AR1C-TS	Toggle Switch	Gray	50
AR1C-TS-W	Toggle Switch White	White	50
AR1C-PO20	20a Receptacle-1.625" Diameter	Gray	50
AR1C-PO30	30a Receptacle-1.75" Diameter	Gray	50
AR1C-PO40	40-50a Receptacle-2.125" Diameter	Gray	50
AR1C-SW	Levers + 15a S. P. Switch	Gray	50
AR1C-SW-W	Levers + 15a S. P. Switch White	White	50
AR1CL-GV	GFCI-Vertical	Gray	50
ARG-1/G-2	Universal 1-Gang/2-Gang Foam Gasket	-	50

WEATHERPROOF



AR1C-SW

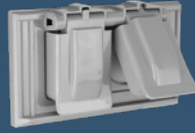

AR1C-DH



AR1C-DH-W



AR1C-DV



AR1C-DV-W



AR1C-GH



AR1C-GH-W

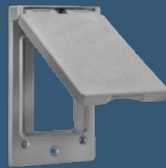

AR1C-GV



AR1C-GV-W



AR1C-SV



AR1C-SV-W



AR1C-TS



AR1C-TS-W

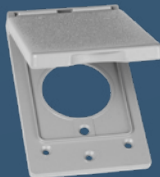

AR1C-PO20

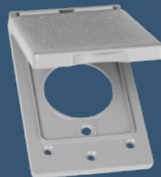

AR1C-PO30

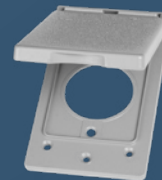

AR1C-PO40



AR1C-SW



AR1C-SW-W

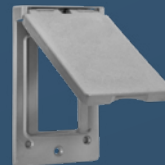

AR1CL-GV

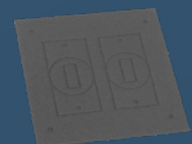

ARG-1/G-2

Two gang Weatherproof Covers



AMMO#	DESCRIPTION	COLOR	PKG
AR2C-SW	Two Levers - Two 15a S.p. Switches	Gray	50
AR2C-SW-W	Two Levers - Two 15a S.p. Switches White	White	50
AR2C-2D	Two Duplex	Gray	50
AR2C-2D-W	Device Mount, 2 Duplex Cover	White	50
AR2C-DH	Oversize One Duplex-Horizontal	Gray	50
AR2C-2G	Two GFCI	Gray	50
AR2C-GD	One GFCI One Duplex	Gray	50
AR2C-2S	Two Switches Or S/R-1.41" Diameter	Gray	50
AR2C-GS	One GFCI One Switch Or S/R-1.41" Diameter	Gray	50
AR2C-SD	One Duplex One Switch Or S/R-1.41" Diameter	Gray	50
AR2C-PO50	40-50a Receptacle-2.125" Diameter one 30,50,60 Amp 3 & 4 Wire With Built-In Padlock	Gray	50
AR2C-PO60	Hasp-2.64" Diameter	Gray	50



AR2C-SW



AR2C-SW-W

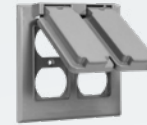

AR2C-2D



AR2C-2D-W



AR2C-DH

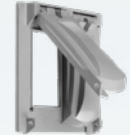

AR2C-2G

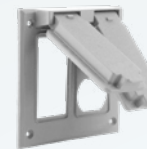

AR2C-GD



AR2C-2S

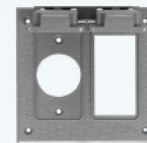

AR2C-GS



AR2C-SD



AR2C-PO50
AR2C-PO50

Three Gang Weatherproof Covers



AMMO#	DESCRIPTION	COLOR	PKG
AR3C-3D	Three Duplex	Gray	20
AR3C-3G	Three GFCI	Gray	20
AR3C-3S	Three Switches Or Single Receptacle 1.41"	Gray	50
AR3RC-TS	Ar3rc-TS (Ar3rc-TS - Flat, Toggle Switch)	Gray	20



AR3C-3D



AR3C-3G



AR3C-3S



AR3RC-TS

Single Gang In-Use Covers



AMMO#	TYPE	PKG
ARWIUP-1	Shallow	24
ARWIUP-1D	Deep	24



Double Gang In-Use Covers



AMMO#	TYPE	PKG
ARWIUP-2D	Deep	10



Round Boxes & Extension Rings



AMMO#	HOLES	SIZE	COLOR	CU IN	PKG
ARBRD-4	5	1/2"	Gray	15.8	40
ARBRD-4-W	5	1/2"	Gray	15.8	40
ARRB-7	5	3/4"	Gray	15.8	40
AREXR50-4	4	1/2"	Gray	16.3	
AREXR75-4	4	3/4"	Gray	16.3	40

ARBRD-4

ARBRD-4-W

AREXR50-4

AREXR75-4



ARBRD-4-W



Lampholders



ARRC-3+2LH150-5

AMMO#	SIZE	COLOR	INNER	MASTER
ARLH150-5	120 Par38 150w Lampholder With Outer Gasket	Gray		50
ARRC-3+2LH150-5	120 Par38 150w Lampholder With Round Cover	Gray		50
AR-WPRLH	Weatherproof Rubber Coated Lamp Holder, 600w, 250v ,14 Awg	Black/White	20	200
MSS1	Motion Sensor Switch	White		50



ARLH150-5



AR-WPRLH

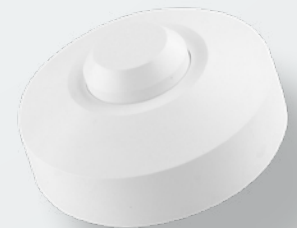

MSS1

Round Lampholder Covers



AMMO#	OUTLET HOLES	HOLE SIZE	COLOR	PKG
ARXC-1	1	1/2"	Gray	50
ARXC-2	1	3/4"	Gray	50
ARRC-1	1	1/2"	Gray	50
ARRC-2	2	1/2"	Gray	50
ARRC-3	3	1/2"	Gray	50
ARRC-1-N	1	1/2"	Gray	50
ARRC-3-N	3	1/2"	Gray	50



ARXC-1

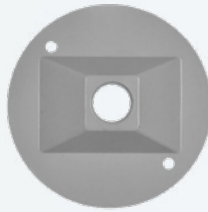

ARRC-1-N



ARRC-1



ARXC-2

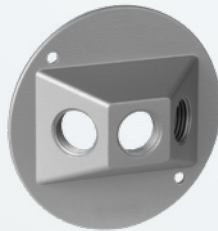

ARRC-3-N

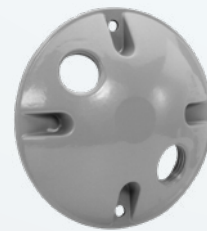

ARRC-2



ARRC-3



One-Gang Lampholder Covers



ARRE-1



ARRE-3



ARRE-2

AMMO#	OUTLET HOLES	HOLE SIZE	COLOR	PKG
ARRE-1	1	1/2"	Gray	50
ARRE-1-W	1	1/2"	White	50
ARRE-2	2	1/2"	Gray	50
ARRE-2-W	2	1/2"	White	50
ARRE-3	3	1/2"	Gray	50
ARRE-3-W	3	1/2"	White	50

Vapor Tight Light Fixtures, Surface and Wall Mount



ARVPF001



ARVPF002

AMMO#	DESCRIPTION	PKG
ARVPF001	Jvl100 Vapor Tight Surface Mount Fixture	6
ARVPF002	Jvl100b Vapor Tight Wall Mount Fixture	6

Service Entrance Caps-Threaded



Screw onto conduit or pipe threads, creating a weather-tight seal for electrical service entrance conductors. Offers robust connection and protection against environmental factors.

AMMO#	TRADE SIZE	PKG
ARSET-50	1/2"	50
ARSET-75	3/4"	50
ARSET-100	1"	50
ARSET-125	1-1/4"	20
ARSET-150	1-1/2"	10
ARSET-200	2"	5
ARSET-250	2-1/2"	2
ARSET-300	3"	1
ARSET-350	3-1/2"	1
ARSET-400	4"	1



Service Entrance Caps-Clamp



Secure onto conduits using clamps. Installation is simpler than threaded caps, while still providing secure and protected connections.



AMMO#	TRADE SIZE	PKG
ARSEC-50	1/2"	50
ARSEC-75	3/4"	50
ARSEC-100	1"	50
ARSEC-125	1-1/4"	20
ARSEC-150	1-1/2"	10
ARSEC-200	2"	5
ARSEC-250	2-1/2"	2
ARSEC-300	3"	1
ARSEC-350	3-1/2"	1
ARSEC-400	4"	1



PVC Service Entrance Caps Wire



AMMO#	TRADE SIZE	PKG
ARPVC-60	#8, 6, 4, 2	50
ARPVC-62	#1/0 to 4/0	10





Service Entrance Mast Kit

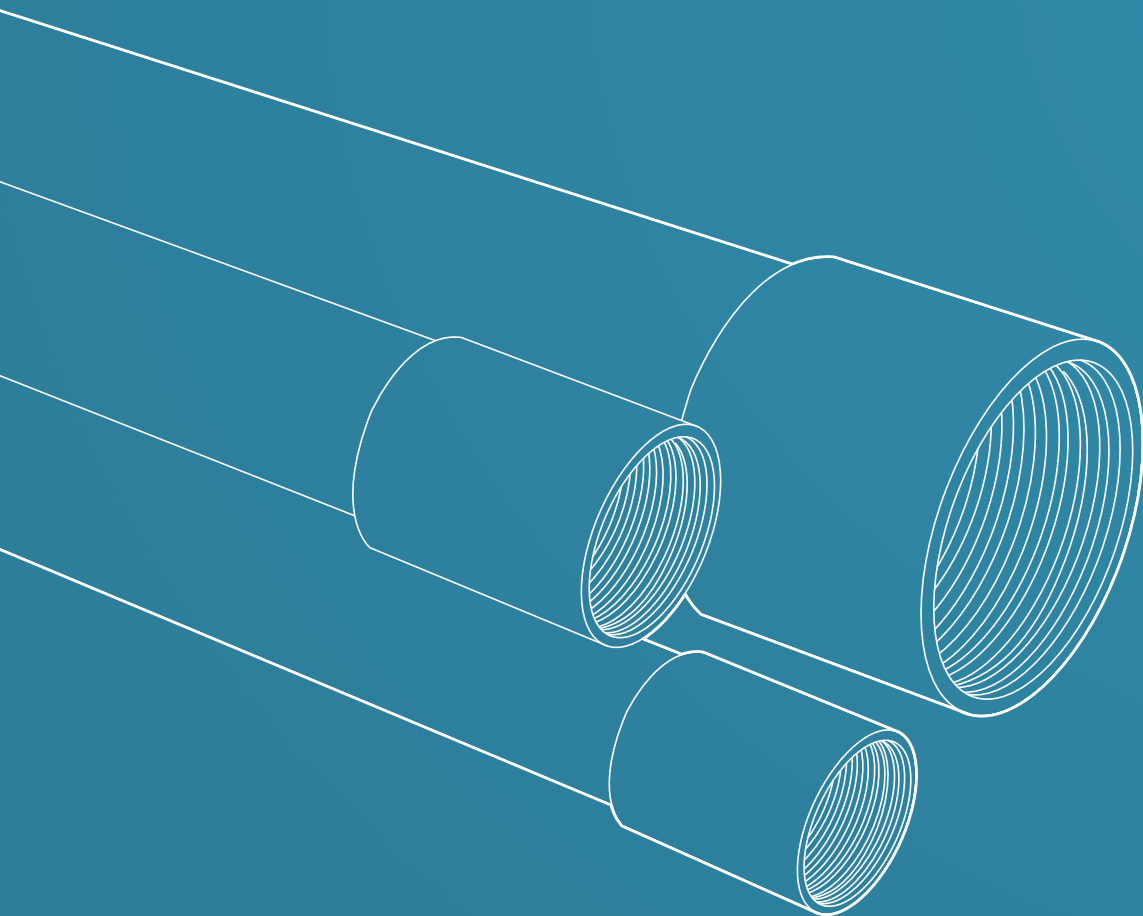

AMMO#	TRADE SIZE	PKG
ARSEMK-200	2"	1

Flexible Steel Conduit	92
Flexible Aluminum Conduit	93
ENT Conduit Coil	94
Flexible Liquid Tight Conduit	95
Flexible Steel Conduit	96
EMT Conduit	97
True Color EMT	98
Rigid Steel Conduit	102
IMC Conduit	103
Aluminum Rigid Conduit	105





ELECTRICAL CONDUIT



Flexible Steel Conduit



AMMO#	SIZE	PKG FT
FSC-50UL	1/2"	100
FSC-75UL	3/4"	100
FSC-100UL	1"	100
FSC-125UL	1-1/4"	50
FSC-150UL	1-1/2"	50
FSC-200UL	2"	50
FSC-250UL	2-1/2"	25
FSC-300UL	3"	25
FSC-350UL	3-1/2"	25
FSC-400UL	4"	25

AMMO#	SIZE	PKG FT
FSC-38UL-RL	3/8"	1000
FSC-50UL-RL	1/2"	1000
FSC-75UL-RL	3/4"	500
FSC-100UL-RL	1"	400

Used to provide protection from damage to electrical cables and other equipment



AMMO#	SIZE	PKG FT
FSC-50	1/2"	100
FSC-75	3/4"	100
FSC-100	1"	100
FSC-125	1-1/4"	50
FSC-150	1-1/2"	50
FSC-200	2"	50
FSC-250	2-1/2"	25
FSC-300	3"	25
FSC-350	3-1/2"	25
FSC-400	4"	25

Flexible Aluminium Conduit



Coil



Reel



AMMO#	SIZE	PKG FT
FLXAL250-38	3/8"	250
FLXAL100-38	3/8"	100
FLXAL100-50	1/2"	100
FLXAL100-75	3/4"	100
FLXAL100-100	1"	100
FLXAL100-125	1-1/4"	50
FLXAL100-150	1-1/2"	25
FLXAL100-200	2"	25
FLXAL100-250	2-1/2"	25
FLXAL100-300	3"	25
FLXAL100-350	3-1/2"	25
FLXAL100-400	4"	25

AMMO#	SIZE	PKG FT
FLXAL-38S	3/8"	1000
FLXAL-50S	1/2"	1000
FLXAL-75S	3/4"	500
FLXAL-100S	1"	400
FLXAL-125S	1-1/4"	200
FLXAL-150S	1-1/2"	100
FLXAL-200S	2"	1000

ENT Conduit Coil



AMMO#	SIZE	PKG FT
ARENT200F-50	1/2"	2 Rolls of 200"
ARENT100F-75	3/4"	2 Rolls of 100"
ARENT100F-100	1"	1 Roll of 100"

ENT Conduit Reel



AMMO#	SIZE	PKG FT
ARENT-50R	1/2"	1500 Reel
ARENT-75R	3/4"	1000 Reel
ARENT-100R	1"	750 Reel
ARENT-125R	1-1/4"	1000 Reel
ARENT-150R	1-1/2"	750 Reel
ARENT-200R	2"	500 Reel



Flexible Liquid Tight Conduit

Used to provide protection from damage to electrical cables and other equipment



AMMO#	SIZE	PKG FT
LTM-50UL	1/2"	100
LTM-75UL	3/4"	100
LTM-100UL	1"	100
LTM-125UL	1-1/4"	50
LTM-150UL	1-1/2"	50
LTM-200UL	2"	50
LTM-250UL	2-1/2"	25
LTM-300UL	3"	25
LTM-350UL	3-1/2"	25
LTM-400UL	4"	25

AMMO#	SIZE	PKG FT
LTM-38UL-RL	3/8"	1000
LTM-50UL-RL	1/2"	1000
LTM-75UL-RL	3/4"	500
LTM-100UL-RL	1"	400



AMMO#	SIZE	PKG FT
LTM-50	1/2"	100
LTM-75	3/4"	100
LTM-100	1"	100
LTM-125	1-1/4"	50
LTM-150	1-1/2"	50
LTM-200	2"	50
LTM-250	2-1/2"	25
LTM-300	3"	25
LTM-350	3-1/2"	25
LTM-400	4"	25

Liquid Tight Non-Metallic Tubing



AMMO#	SIZE	PKG FT
38LT100UL	3/8"	100' Roll
12LT100UL	1/2"	100' Roll
34LT100UL	3/4"	100' Roll
1LT100UL	1"	100' Roll
125LT50UL	1-1/4"	50' Roll
150LT50UL	1-1/2"	50' Roll
2LT50UL	2"	50' Roll



EMT Conduit

 *EMT HOT DIP GALVANIZING process for greater protection against corrosion. Finished with durable and clear anti-corrosion coating for higher protection outside and higher grade epoxy coating inside.*



AMMO#	TRADE SIZE		NOMINAL OD		WALL THICK.A		APROX 100FTAP		PKG	
	US	METRIC	IN.	MM	IN.	MM	LB.	KG	FT.	PCS
1/2-10-EMT	1/2	16	0.706	17.93	0.042	1.07	30	13.6	7000	700
3/4-10-EMT	3/4"	21	0.922	23.42	0.049	1.25	46	20.9	5000	500
1-10-EMT	1	27	1.163	29.54	0.057	1.45	67	30.4	3000	300
1-1/4-10-EMT	1-1/4	35	1.51	38.35	0.065	1.65	101	45.8	2000	200
1-1/2-10-EMT	1-1/2	41	1.74	44.20	0.065	1.65	116	52.6	1500	150
2-10-EMT	2	53	2.197	55.80	0.065	1.65	148	67.1	1200	120
2-1/2-10-EMT	2-1/2	63	2.875	73.03	0.072	1.83	216	98	610	61
3-10-EMT	3	78	3.5	88.90	0.072	1.83	263	119.3	510	51
3-1/2-10-EMT	3-1/2	91	4	101.60	0.083	2.11	349	158.3	370	37
4-10-EMT	4	103	4.5	114.30	0.083	2.11	393	178.2	300	30

True Color EMT In-Line 10ft Red



AMMO#	SIZE	FT	PCS
1/2-10-RD-EMT	1/2"	2500	250
3/4-10-RD-EMT	3/4"	2000	200
1-10-RD-EMT	1"	1000	100
1-1/4-10-RD-EMT	1-1/4"	500	50
1-1/2-10-RD-EMT	1-1/2"	500	50
2-10-RD-EMT	2"	610	61
2-1/2-10-RD-EMT	2-1/2"	370	37
3-10-RD-EMT	3"	200	20
3-1/2-10-RD-EMT	3-1/2"	100	10
4-10-RD-EMT	4"	100	10



True Color EMT In-Line 10ft Green



AMMO#	SIZE	FT	PCS
1/2-10-GN-EMT	1/2"	2500	250
3/4-10-GN-EMT	3/4"	2000	200
1-10-GN-EMT	1"	1000	100
1-1/4-10-GN-EMT	1-1/4"	500	50
1-1/2-10-GN-EMT	1-1/2"	500	50
2-10-GN-EMT	2"	610	61
2-1/2-10-GN-EMT	2-1/2"	370	37
3-10-GN-EMT	3"	200	20
3-1/2-10-GN-EMT	3-1/2"	100	10
4-10-GN-EMT	4"	100	10

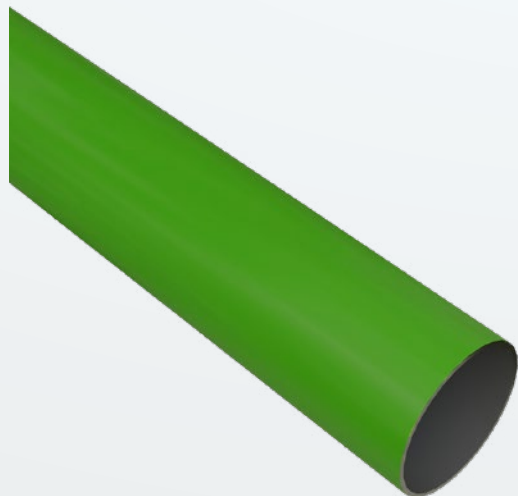

Coming soon



True Color EMT In-Line 10ft Yellow



AMMO#	SIZE	FT	PCS
1/2-10-Y-EMT	1/2"	2500	250
3/4-10-Y-EMT	3/4"	2000	200
1-10-Y-EMT	1"	1000	100
1-1/4-10-Y-EMT	1-1/4"	500	50
1-1/2-10-Y-EMT	1-1/2"	500	50
2-10-Y-EMT	2"	610	61
2-1/2-10-Y-EMT	2-1/2"	370	37
3-10-Y-EMT	3"	200	20
3-1/2-10-Y-EMT	3-1/2"	100	10
4-10-Y-EMT	4"	100	10

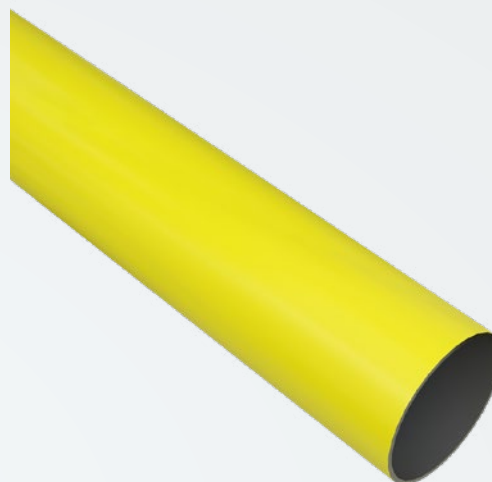

True Color EMT In-Line 10ft Blue



AMMO#	SIZE	FT	PCS
1/2-10-BLU-EMT	1/2"	2500	250
3/4-10-BLU-EMT	3/4"	2000	200
1-10-BLU-EMT	1"	1000	100
1-1/4-10-BLU-EMT	1-1/4"	500	50
1-1/2-10-BLU-EMT	1-1/2"	500	50
2-10-BLU-EMT	2"	610	61
2-1/2-10-BLU-EMT	2-1/2"	370	37
3-10-BLU-EMT	3"	200	20
3-1/2-10-BLU-EMT	3-1/2"	100	10
4-10-BLU-EMT	4"	100	10

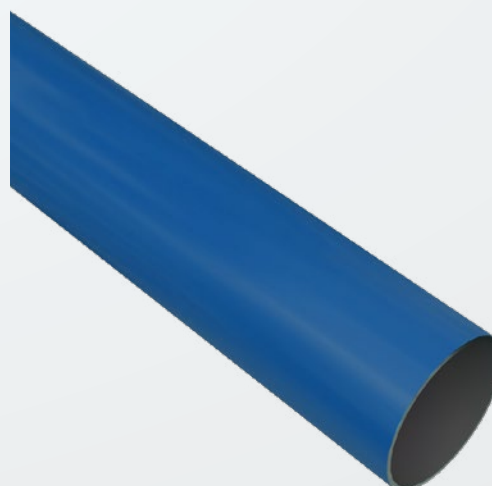

True Color EMT In-Line 10ft Purple



AMMO#	SIZE	FT	PCS
1/2-10-PURP-EMT	1/2"	2500	250
3/4-10-PURP-EMT	3/4 "	2000	200
1-10-PURP-EMT	1"	1000	100
1-1/4-10-PURP-EMT	1-1/4"	500	50
1-1/2-10-PURP-EMT	1-1/2"	500	50
2-10-PURP-EMT	2"	610	61
2-1/2-10-PURP-EMT	2-1/2"	370	37
3-10-PURP-EMT	3"	200	20
3-1/2-10-PURP-EMT	3-1/2"	100	10
4-10-PURP-EMT	4"	100	10



True Color EMT In-Line 10ft Orange



AMMO#	SIZE	FT	PCS
1/2-10-ORG-EMT	1/2"	2500	250
3/4-10-ORG-EMT	3/4 "	2000	200
1-10-ORG-EMT	1"	1000	100
1-1/4-10-ORG-EMT	1-1/4"	500	50
1-1/2-10-ORG-EMT	1-1/2"	500	50
2-10-ORG-EMT	2"	610	61
2-1/2-10-ORG-EMT	2-1/2"	370	37
3-10-ORG-EMT	3"	200	20
3-1/2-10-ORG-EMT	3-1/2"	100	10
4-10-ORG-EMT	4"	100	10



Coming soon



True Color EMT In-Line 10ft White



AMMO#	SIZE	FT	PCS
1/2-10-WH-EMT	1/2"	2500	250
3/4-10-WH-EMT	3/4"	2000	200
1-10-WH-EMT	1"	1000	100





Rigid Steel Conduit



- Hot-dipped galvanized steel provides anti-corrosion and anti-abrasion.
- Organic Interior Diameter coating promotes smooth surface for easy wire pulling.
- High grade mild strip steel provides durability and longevity.
- Maintains ductility, providing easy bending, cutting and joining.
- Threaded on both ends, one fitted with a coupling, one with a color-coded thread protector

AMMO#	TRADE SIZE		NOMINAL OD		WALL THICK.A		APROX 100FTAP		PKG	
	US	METRIC	IN.	MM	IN.	MM	LB.	KG	FT.	PCS
1/2-10-RSC	1/2	16	0.84	21.3	0.104	2.6	82	37.2	2500	250
3/4-10-RSC	3/4"	21	1.05	26.7	0.107	2.7	109	49.4	2000	200
1-10-RSC	1	27	1.315	33.4	0.126	3.2	161	73	1250	125
1-1/4-10-RSC	1-1/4	35	1.66	42.2	0.133	3.4	218	98.9	900	90
1-1/2-10-RSC	1-1/2	41	1.9	48.3	0.138	3.5	263	119.3	800	80
2-10-RSC	2	53	2.375	60.3	0.146	3.7	350	158.7	600	60
2-1/2-10-RSC	2-1/2	63	2.875	73	0.193	4.9	559	253.5	370	37
3-10-RSC	3	78	3.5	88.9	0.205	5.2	727	329.7	300	30
3-1/2-10-RSC	3-1/2	91	4	101.6	0.215	5.5	880	399.1	250	25
4-10-RSC	4	103	4.5	114.3	0.225	5.7	1030	467.1	200	20
5-10-RSC	5	129	5.5	141.3	0.245	6.2	1400	634.9	150	15
6-10-RSC	6	155	6.6	168.2	0.266	6.8	1840	834.5	100	10

Outside diameter tolerances:
 +/- .015 in. (.38mm) for trade sizes 1/2" (16mm) through 1 1/2" (41mm), +/- 1% for trade size 2" (53mm) through 6" (155mm) Wall thickness tolerances: +/- 12.5%
 NOTE: Length = 10 ft. (3.05m) with a tolerance of +/- .25" (6.35mm)
 The length of straight conduit, and the weight of finished zinc-coated conduit or bare threaded tube to be coated with an alternate corrosion-resistant coating with one coupling.

ELECTRICAL CONDUIT



IMC Conduit



AMMO#	TRADE SIZE		NOMINAL OD		WALL THICK.A		APROX 100FTAP		PKG	
	US	METRIC	IN.	MM	IN.	MM	LB.	KG	FT.	PCS
1/2-10-IMC	1/2	16	0.815	20.70	0.104	2.6	62	28.12	3500	350
3/4-10-IMC	3/4"	21	1.029	26.14	0.107	2.7	84	38.10	2500	250
1-10-IMC	1	27	1.290	32.77	0.126	3.2	119	53.98	1700	170
1-1/4-10-IMC	1-1/4	35	1.638	41.59	0.133	3.4	158	71.67	1350	135
1-1/2-10-IMC	1-1/2	41	1.883	47.82	0.138	3.5	194	88.00	1100	110
2-10-IMC	2	53	2.360	59.93	0.146	3.7	256	116.12	800	80
2-1/2-10-IMC	2-1/2	63	2.857	72.57	0.193	4.9	441	200.04	370	37
3-10-IMC	3	78	3.476	88.29	0.205	5.2	543	246.30	300	30
3-1/2-10-IMC	3-1/2	91	3.971	100.86	0.215	5.5	629	285.31	240	24
4-10-IMC	4	103	4.466	113.44	0.225	5.7	700	317.52	240	24

Electrical IMC is commonly used in commercial and industrial settings because it is more durable and can withstand harsh environments and physical damage better than other types of conduit, such as PVC or EMT (Electrical Metallic Tubing). It is also commonly used in areas where fire resistance is important, as it has a higher fire rating than PVC or EMT. Hot-dip galvanized outside and inside.



ELECTRICAL CONDUIT

Aluminium Rigid Conduit



AMMO#	TRADE SIZE		NOMINAL OD		WALL THICK.A		APROX 100FTAP		PKG	
	US	Metric	in.	mm	in.	mm	lb.	kg	ft.	pcs
1/2-10-ALU	1/2	16	0.84	21.3	0.104	2.6	28.1	12.7	2500	250
3/4-10-ALU	3/4"	21	1.05	26.7	0.107	2.7	37.4	17.0	2500	250
1-10-ALU	1	27	1.315	33.4	0.126	3.2	54.5	24.7	2000	200
1-1/4-10-ALU	1-1/4	35	1.66	42.2	0.133	3.4	71.6	32.5	1000	100
1-1/2-10-ALU	1-1/2	41	1.9	48.3	0.138	3.5	88.7	40.2	1000	100
2-10-ALU	2	53	2.375	60.3	0.146	3.7	118.5	53.8	450	45
2-1/2-10-ALU	2-1/2	63	2.875	73	0.193	4.9	187.5	85.0	300	30
3-10-ALU	3	78	3.5	88.9	0.205	5.2	246.3	111.7	200	20
3-1/2-10-ALU	3-1/2	91	4	101.6	0.215	5.5	295.6	134.1	200	20
4-10-ALU	4	103	4.5	114.3	0.225	5.7	350.2	155.8	200	20
5-10-ALU	5	129	5.563	141.3	0.245	6.2	478.9	217.2	80	8
6-10-ALU	6	155	6.625	168.3	0.266	6.8	630.4	285.9	60	6



Combines light weight and corrosion resistance to provide a full-line of easy to install, low maintenance conduit whenever specifications call for aluminum.

Outside diameter tolerances:

+/- .015 in. (.38mm) for trade sizes 1/2" (16mm) through 1 1/2" (41mm), +/-1% for trade size 2" (53mm) through 6" (155mm) Wall thickness tolerances: +/-12.5%

NOTE: Length = 10 ft. (3.05m) with a tolerance of +/- .25" (6.35mm)

EMT Elbows _____	108
Rigid Elbows _____	110
Aluminum Elbows _____	112
Rigid Conduit Nipples _____	114
Rigid Couplings _____	118
Aluminum Couplings _____	119

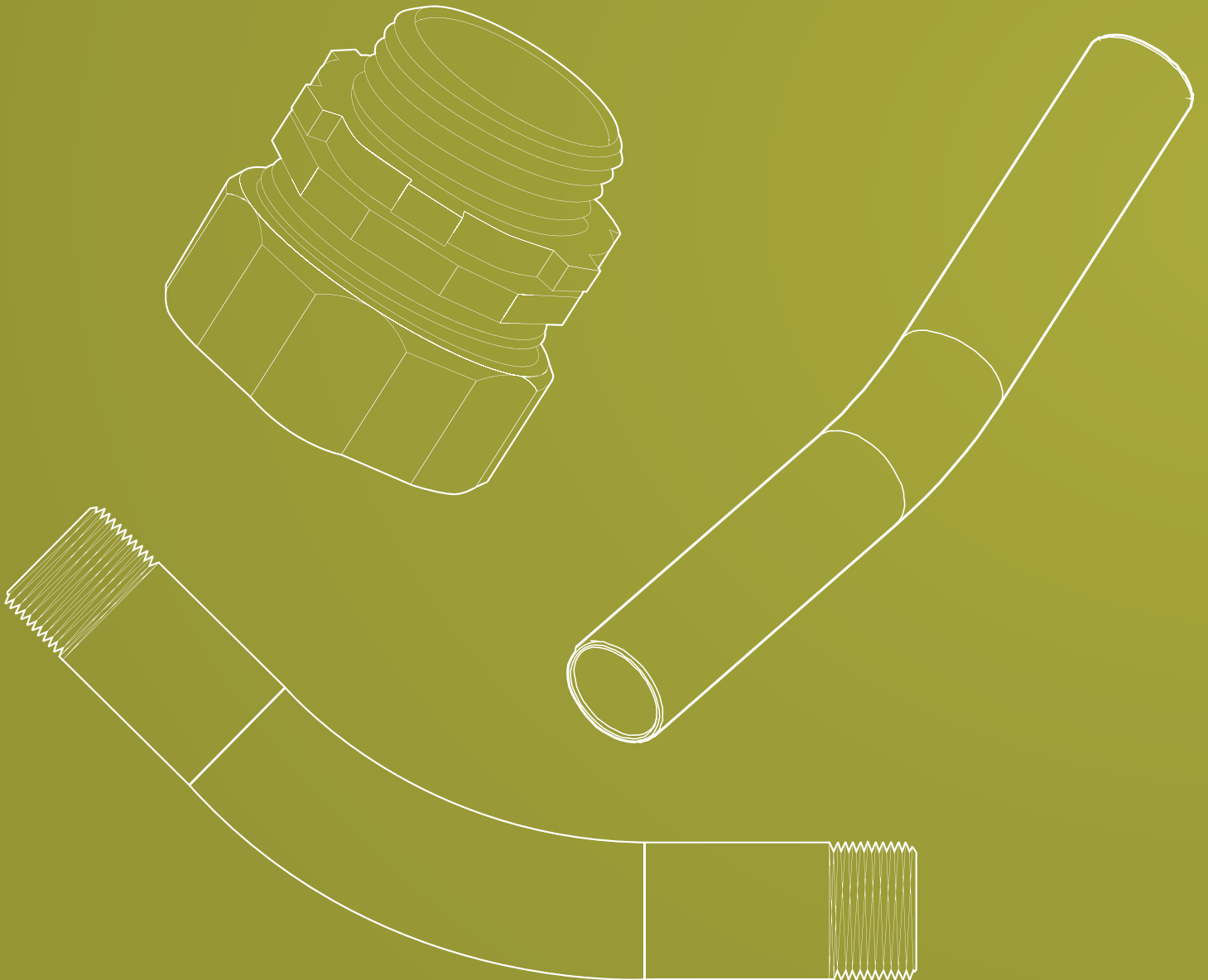



NIPPLES, ELBOWS & COUPLINGS



EMT Conduit Elbows Galvanized Steel

15° EMT Elbow



AMMO#	SIZE	PKG
AREMT-12515	1-1/4"	20
AREMT-15015	1-1/2"	20
AREMT-20015	2"	10
AREMT-25015	2-1/2"	50
AREMT-30015	3"	35
AREMT-35015	3-1/2"	35
AREMT-40015	4"	35

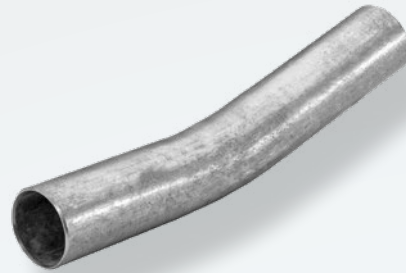

22.5° EMT Elbow



AMMO#	SIZE	PKG
AREMT-12522	1-1/4"	20
AREMT-15022	1-1/2"	20
AREMT-20022	2"	10
AREMT-25022	2-1/2"	50
AREMT-30022	3"	35
AREMT-35022	3-1/2"	35
AREMT-40022	4"	35



30° EMT Elbow



#AMMO	SIZE	PKG
AREMT-12530	1-1/4"	20
AREMT-15030	1-1/2"	20
AREMT-20030	2"	10
AREMT-25030	2-1/2"	50
AREMT-30030	3"	35
AREMT-35030	3-1/2"	35
AREMT-40030	4"	35



45° EMT Elbow



AMMO#	SIZE	PKG
AREMT-5045	1/2"	50
AREMT-7545	3/4"	50
AREMT-10045	1"	35
AREMT-12545	1-1/4"	30
AREMT-15045	1-1/2"	15
AREMT-20045	2"	15
AREMT-25045	2-1/2"	50
AREMT-30045	3"	40
AREMT-35045	3-1/2"	35
AREMT-40045	4"	35



90° EMT Elbow



AMMO#	SIZE	PKG
AREMT-5090	1/2"	50
AREMT-7590	3/4"	50
AREMT-10090	1"	25
AREMT-12590	1-1/4"	20
AREMT-15090	1-1/2"	20
AREMT-20090	2"	10
AREMT-25090	2-1/2"	1
AREMT-30090	3"	1
AREMT-35090	3-1/2"	1
AREMT-40090	4"	1



Special Radius EMT Elbow



AMMO#	SIZE	PKG
ARSEMT-29024	2"X60X24	1
ARSEMT-29036	2"X90X36	1
ARSEMT-39036	3"X90X36	1





Rigid Conduit Elbows Hot Dip Galvanized Steel

 Experience long-lasting durability and easy installation with our low conductivity, high corrosion-resistant, and smooth, defect-free finish.

15° Rigid Elbow



AMMO#	SIZE	PKG
ARRE-12515	1-1/4"	20
ARRE-15015	1-1/2"	15
ARRE-20015	2"	10
ARRE-25015	2-1/2"	50
ARRE-30015	3"	35
ARRE-35015	3-1/2"	35
ARRE-40015	4"	35



22.5° Rigid Elbow



AMMO#	SIZE	PKG
ARRE-12522	1-1/4"	20
ARRE-15022	1-1/2"	15
ARRE-20022	2"	10
ARRE-25022	2-1/2"	50
ARRE-30022	3"	35
ARRE-35022	3-1/2"	35
ARRE-40022	4"	35



30° Rigid Elbow



AMMO#	SIZE	PKG
ARRE-12530	1-1/4"	20
ARRE-15030	1-1/2"	15
ARRE-20030	2"	10
ARRE-25030	2-1/2"	50
ARRE-30030	3"	35
ARRE-35030	3-1/2"	35
ARRE-40030	4"	35



NIPPLES ELBOWS & COUPLINGS

45° Rigid Elbow



AMMO#	SIZE	PKG
ARRE-5045	1/2"	50
ARRE-7545	3/4"	50
ARRE-10045	1"	35
ARRE-12545	1-1/4"	30
ARRE-15045	1-1/2"	15
ARRE-20045	2"	15
ARRE-25045	2-1/2"	1
ARRE-30045	3"	1
ARRE-35045	3-1/2"	1
ARRE-40045	4"	1



90° Rigid Elbow



AMMO#	SIZE	PKG
ARRE-5090	1/2"	50
ARRE-7590	3/4"	50
ARRE-10090	1"	20
ARRE-12590	1-1/4"	20
ARRE-15090	1-1/2"	10
ARRE-20090	2"	10
ARRE-25090	2-1/2"	1
ARRE-30090	3"	1
ARRE-35090	3-1/2"	1
ARRE-40090	4"	1
ARRE-50090	5"	1
ARRE-60090	6"	1



LG Radius Rigid Elbow



AMMO#	SIZE	PKG
ARRE39036	3"X90X36	1
ARRE49036	4"X90X36	1
ARRE59036	5"X90X36	1
ARRE69036	6"X90X36	1



Special Radius Rigid Elbow



AMMO#	SIZE	PKG
ARSRRE-29024	2"X90X24	1
ARSRRE-29036	2"X90X36	1





Rigid Conduit Elbows **Aluminum 6063**

 *Ideal for harsh or clean environments, including wastewater treatment, food processing, oil refineries, paper mills, and power plants.*

22.5° Deg Rigid Aluminum Elbow



AMMO#	SIZE	PKG
ARALU-12522	1-1/4"	20
ARALU-15022	1-1/2"	15
ARALU-20022	2"	10
ARALU-25022	2-1/2"	50
ARALU-30022	3"	35
ARALU-35022	3-1/2"	35
ARALU-40022	4"	35

30° Deg Rigid Aluminum Elbow



AMMO#	SIZE	PKG
ARALU-12530	1-1/4"	20
ARALU-15030	1-1/2"	15
ARALU-20030	2"	10
ARALU-25030	2-1/2"	50
ARALU-30030	3"	35
ARALU-35030	3-1/2"	35
ARALU-40030	4"	35

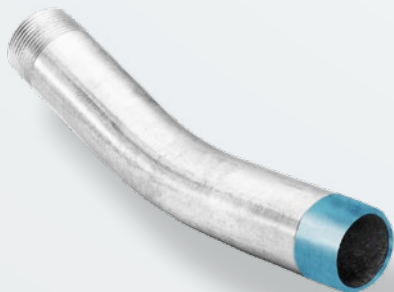

45° Deg Rigid Aluminum Elbow



AMMO#	SIZE	PKG
ARALU-5045	1/2"	50
ARALU-7545	3/4"	50
ARALU-10045	1"	35
ARALU-12545	1-1/4"	30
ARALU-15045	1-1/2"	15
ARALU-20045	2"	15
ARALU-25045	2-1/2"	1
ARALU-30045	3"	1
ARALU-35045	3-1/2"	1
ARALU-40045	4"	1
ARALU-50045	5"	1
ARALU-60045	6"	1



90° Deg Rigid Aluminum Elbow



AMMO#	SIZE	PKG
ARALU-5090	1/2"	50
ARALU-7590	3/4"	50
ARALU-10090	1"	35
ARALU-12590	1-1/4"	30
ARALU-15090	1-1/2"	15
ARALU-20090	2"	15
ARALU-25090	2-1/2"	1
ARALU-30090	3"	1
ARALU-35090	3-1/2"	1
ARALU-40090	4"	1
ARALU-50090	5"	1
ARALU-60090	6"	1



Rigid Conduit Nipples Galvanized Steel

High-strength ductile steel ensures long life and easy bending, providing smooth, continuous raceways for fast wire-pulling.

Conduit Nipples Type C



AMMO#	SIZE	INNER	MASTER
ARCN-50C	1/2" X C"	25	600
ARCN-75C	3/4" X C	25	600
ARCN-100C	1" X C	25	300
ARCN-125C	1-1/4" X C"	25	150
ARCN-150C	1-1/2" X C	25	100
ARCN-200C	2" X C	25	75
ARCN-250C	2-1/2" X C"	-	10
ARCN-300C	3" X C"	-	10
ARCN-350C	3-1/2" X C"	-	10
ARCN-400C	4" X C	-	10

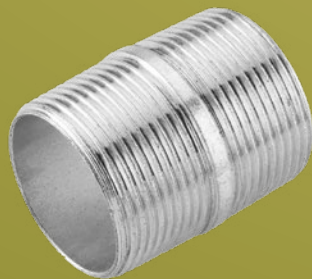

Conduit Nipples 1/2"



AMMO#	SIZE	INNER	MASTER
ARCN-50150	1/2" X 1-1/2"	25	600
ARCN-50200	1/2" X 2"	25	600
ARCN-50250	1/2" X 2-1/2"	25	400
ARCN-50300	1/2" X 3"	25	300
ARCN-50350	1/2" X 3-1/2"	25	300
ARCN-50400	1/2" X 4"	25	200
ARCN-50500	1/2" X 5"	25	200
ARCN-50600	1/2" X 6"	-	25
ARCN-50800	1/2" X 8"	-	25
ARCN-501000	1/2" X 10"	-	25
ARCN-501200	1/2" X 12"	-	25

Conduit Nipples 3/4"



AMMO#	SIZE	INNER	MASTER
ARCN-75150	3/4" X 1-1/2"	25	300
ARCN-75200	3/4" X 2"	25	300
ARCN-75250	3/4" X 2-1/2"	25	300
ARCN-75300	3/4" X 3"	25	200
ARCN-75350	3/4" X 3-1/2"	-	25
ARCN-75400	3/4" X 4"	25	150
ARCN-75500	3/4" X 5"	25	150
ARCN-75600	3/4" X 6"	25	150
ARCN-75800	3/4" X 8"	-	25
ARCN-751000	3/4" X 10"	-	1
ARCN-751200	3/4" X 12"	-	1

Conduit Nipples 1-1/4"



AMMO#	SIZE	INNER	MASTER
ARCN-125200	1-1/4" X 2"	25	150
ARCN-125250	1-1/4" X 2-1/2"	-	25
ARCN-125300	1-1/4" X 3"	-	25
ARCN-125350	1-1/4" X 3-1/2"	-	25
ARCN-125400	1-1/4" X 4"	25	75
ARCN-125500	1-1/4" X 5"	25	50
ARCN-125600	1-1/4" X 6"	25	50
ARCN-125800	1-1/4" X 8"	25	25
ARCN-1251000	1-1/4" X 10"	-	25
ARCN-1251200	1-1/4" X 12"	-	20

Conduit Nipples 1"



AMMO#	SIZE	INNER	MASTER
ARCN-100200	1" X 2"	-	25
ARCN-100250	1" X 2-1/2"	25	150
ARCN-100300	1" X 3"	25	150
ARCN-100350	1" X 3-1/2"	25	100
ARCN-100400	1" X 4"	25	100
ARCN-100500	1" X 5"	-	25
ARCN-100600	1" X 6"	25	75
ARCN-100800	1" X 8"	-	25
ARCN-1001000	1" X 10"	-	25
ARCN-1001200	1" X 12"	-	25



Conduit Nipples 1-1/2"



AMMO#	SIZE	INNER	MASTER
ARCN-150200	1-1/2" X 2"	-	25
ARCN-150250	1-1/2" X 2-1/2"	-	25
ARCN-150300	1-1/2" X 3"	-	25
ARCN-150350	1-1/2" X 3-1/2"	-	25
ARCN-150400	1-1/2" X 4"	25	50
ARCN-150500	1-1/2" X 5"	25	50
ARCN-150600	1-1/2" X 6"	-	25
ARCN-150800	1-1/2" X 8"	-	25
ARCN-1501000	1-1/2" X 10"	-	20
ARCN-1501200	1-1/2" X 12"	-	10



Conduit Nipples 2"



AMMO#	SIZE	INNER	MASTER
ARCN-200250	2-1/2"	25	50
ARCN-200300	2" X 3"	25	50
ARCN-200350	2" X 3/1/2"	-	10
ARCN-200400	2" X 4"	-	25
ARCN-200500	2" X 5"	-	25
ARCN-200600	2" X 6"	-	10
ARCN-200700	2" X 7"	-	10
ARCN-200800	2" X 8"	-	10
ARCN-2001000	2" X 10"	-	10
ARCN-2001200	2" X 12"	-	10

Conduit Nipples 2-1/2"



AMMO#	SIZE	PKG
ARCN-250300	2-1/2" X 3"	10
ARCN-250350	2-1/2" X 3.5"	10
ARCN-250400	2-1/2" X 4"	10
ARCN-250500	2-1/2" X 5"	10
ARCN-250600	2-1/2" X 6"	10
ARCN-250800	2-1/2" X 8"	5
ARCN-2501000	2-1/2" X 10"	5
ARCN-2501200	2-1/2" X 12"	5

Conduit Nipples 3"



AMMO#	SIZE	PKG
ARCN-300300	3" X 3"	10
ARCN-300350	3" X 3-1/2"	10
ARCN-300400	3" X 4"	10
ARCN-300500	3" X 5"	10
ARCN-300600	3" X 6"	10
ARCN-300800	3" X 8"	5
ARCN-3001000	3" X 10"	5
ARCN-3001200	3" X 12"	5

Conduit Nipples 3-1/2"



AMMO#	SIZE	PKG
ARCN-350400	3-1/2" X 4"	10
ARCN-350500	3-1/2" X 5"	5
ARCN-350600	3-1/2" X 6"	5
ARCN-350800	3-1/2" X 8"	5
ARCN-3501000	3-1/2" X 10"	5
ARCN-3501200	3-1/2" X 12"	5

Conduit Nipples 4"



AMMO#	SIZE	PKG
ARCN-400400	4" X 4"	5
ARCN-400500	4" X 5"	5
ARCN-400600	4" X 6"	5
ARCN-400800	4" X 8"	5
ARCN-4001000	4" X 10"	3
ARCN-4001200	4" X 12"	2



Rigid Couplings **Zinc Plated Steel**



Maintains mechanical protection and solid grounding of one conduit to another.



AMMO#	SIZE	PKG
ARRC-50	1/2"	150
ARRC-75	3/4"	50
ARRC-100	1"	30
ARRC-125	1-1/4"	25
ARRC-150	1-1/2"	25
ARRC-200	2"	20
ARRC-250	2-1/2"	12
ARRC-300	3"	8
ARRC-350	3-1/2"	4
ARRC-400	4"	4
ARRC-500	5"	2
ARRC-600	6"	1



Rigid Couplings

Aluminum 6063



Corrosion Resistant Aluminum resists most corrosive atmospheres in industrial environments



AMMO#	SIZE	PKG
ARAC-50	1/2"	150
ARAC-75	3/4"	50
ARAC-100	1"	30
ARAC-125	1-1/4"	25
ARAC-150	1-1/2"	25
ARAC-200	2"	20
ARAC-250	2-1/2"	12
ARAC-300	3"	8
ARAC-350	3-1/2"	4
ARAC-400	4"	4



PVC Conduit	122
Rigid PVC Conduit	123
PVC Conduit Bodies	126
PVC Elbow Sch40	128
PVC Elbow Sch80	130
PVC Fittings	132

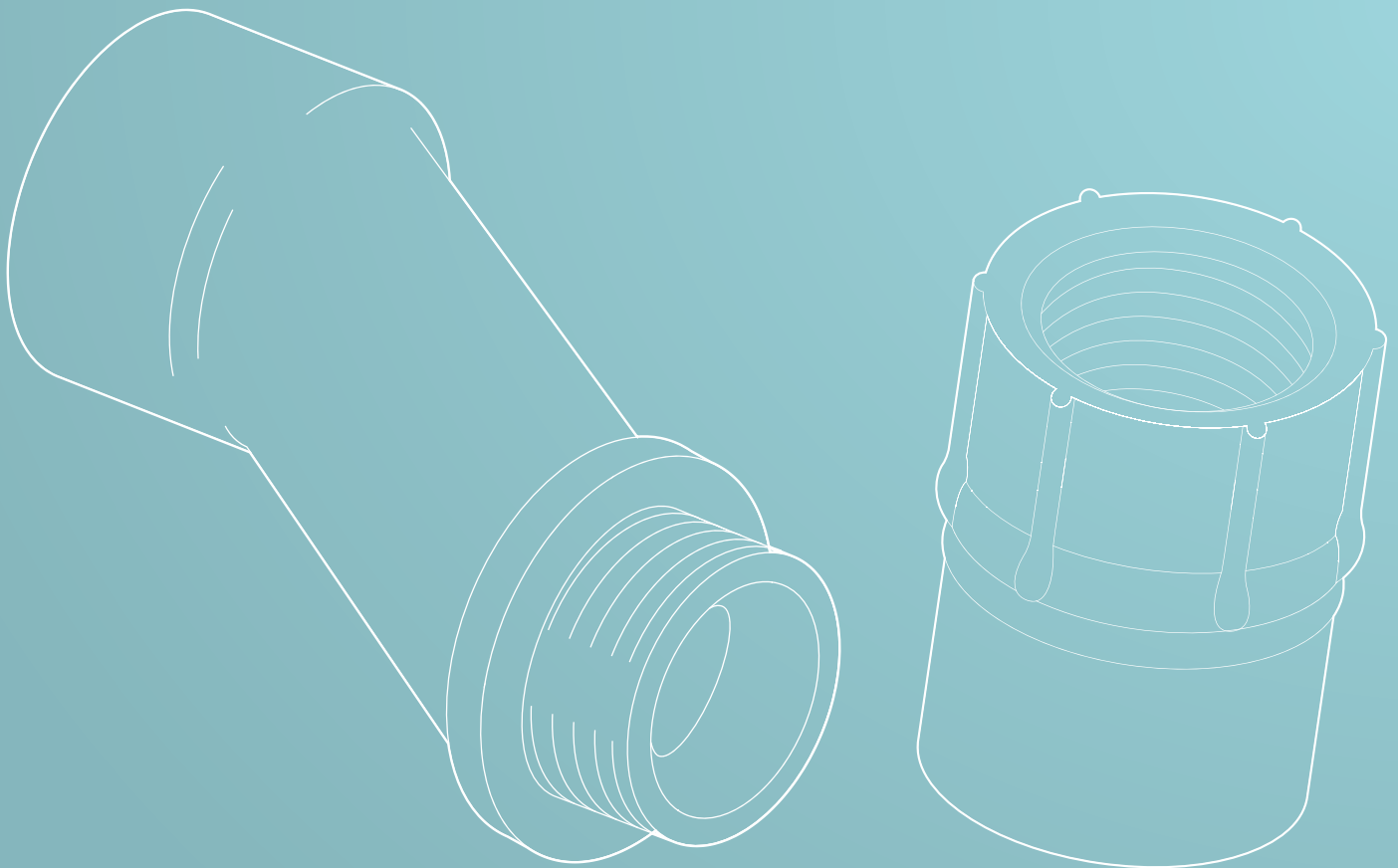

PVC



SCH40 PVC Conduit Bell End



AMMO#	Size	Minimum wall (T)	Lenght Feet	Bell End (B)	Feet per PKG
1/2-10-PVC-40	1/2	0.109	10	1.77	6,000
3/4-10-PVC-40	3/4	0.113	10	2.16	4,400
1-10-PVC-40	1	0.133	10	2.56	3,600
1-1/4-10-PVC-40	1-1/4	0.14	10	3.15	3,300
1-1/2-10-PVC-40	1-1/2	0.145	10	3.15	2,250
2-10-PVC-40	2	0.15	10	3.15	1,400
2-1/2-10-PVC-40	2-1/2	0.203	10	3.15	930
3-10-PVC-40	3	0.216	10	3.94	880
3-1/2-10-PVC-40	3-1/2	0.226	10	3.94	630
4-10-PVC-40	4	0.237	10	3.94	570
5-10-PVC-40	5	0.258	10	3.94	380
6-10-PVC-40	6	0.28	10	5.9	260
8-10-PVC-40*	8	0.332	10	-	180

*Non certification, in follow instructions UL directory

SCH80 PVC Conduit Bell End



AMMO#	Size	Minimum wall (T)	Lenght Feet	Bell End (B)	Feet per PKG
1/2-10-PVC-80	1/2	0.147	10	1.77	6,000
3/4-10-PVC-80	3/4	0.154	10	2.16	4,400
1-10-PVC-80	1	0.179	10	2.56	3,600
1-1/4-10-PVC-80	1-1/4	0.191	10	3.15	3,300
1-1/2-10-PVC-80	1-1/2	0.2	10	3.15	2,250
2-10-PVC-80	2	0.218	10	3.15	1,400
2-1/2-10-PVC-80	2-1/2	0.276	10	3.15	930
3-10-PVC-80	3	0.3	10	3.94	880
3-1/2-10-PVC-80	3-1/2	0.318	10	3.94	630
4-10-PVC-80	4	0.337	10	3.94	570
5-10-PVC-80	5	0.375	10	3.94	380
6-10-PVC-80	6	0.432	10	5.9	260
8-10-PVC-80*	8	0.5	10	-	180

Ammo's Tube & Conduit products offer a complete line of rigid PVC conduit and fittings as well as PVC utility duct. They are for commercial, industrial and utility usage and are proven durable and effective for years. Our tube & conduit offer a maintenance-free performance in underground, encased and exposed applications in accordance with the National Electrical Code.

SCH40 PVC Conduit Bell End



AMMO#	Size	Minimum wall (T)	Length Feet	Bell End (B)	Feet per PKG
1/2-20-PVC-40	1/2	0.109	20	1.77	12,000
3/4-20-PVC-40	3/4	0.113	20	2.16	8,800
1-20-PVC-40	1	0.133	20	2.56	7,200
1-1/4-20-PVC-40	1-1/4	0.14	20	3.15	6,600
1-1/2-20-PVC-40	1-1/2	0.145	20	3.15	4,500
2-20-PVC-40	2	0.15	20	3.15	2,800
2-1/2-20-PVC-40	2-1/2	0.203	20	3.15	1,860
3-20-PVC-40	3	0.216	20	3.94	1,760
3-1/2-20-PVC-40	3-1/2	0.226	20	3.94	1,260
4-20-PVC-40	4	0.237	20	3.94	1,140
5-20-PVC-40	5	0.258	20	3.94	760
6-20-PVC-40	6	0.280	20	5.9	520
8-20-PVC-40*	8	0.332	20	-	360

SCH80 PVC Conduit Bell End



AMMO#	Size	Minimum wall (T)	Length Feet	Bell End (B)	Feet per PKG
1/2-20-PVC-80	1/2	0.147	20	1.77	12,000
3/4-20-PVC-80	3/4	0.154	20	2.16	8,800
1-20-PVC-80	1	0.179	20	2.56	7,200
1-1/4-20-PVC-80	1-1/4	0.191	20	3.15	6,600
1-1/2-20-PVC-80	1-1/2	0.2	20	3.15	4,500
2-20-PVC-80	2	0.218	20	3.15	2,800
2-1/2-20-PVC-80	2-1/2	0.276	20	3.15	1,860
3-20-PVC-80	3	0.3	20	3.94	1,760
3-1/2-20-PVC-80	3-1/2	0.318	20	3.94	1,260
4-20-PVC-80	4	0.337	20	3.94	1,140
5-20-PVC-80	5	0.375	20	3.94	760
6-20-PVC-80	6	0.432	20	5.9	520
8-20-PVC-80*	8	0.5	20	-	180



5" Rigid PVC Conduit Type DB 60 - 20 FT

AMMO# DB60-5-20-PVC



DIMENSIONS							
STANDARD PARAMETERS							
WALL THICKNESSES (mm)			OUTSIDE DIMETERS (mm)	OUT-OF ROUNDNESS (mm)	TOLERANCE (mm)	MINIMUM AVERAGE INSIDE DIAMETER	VARIATION
MIN	NORMAL	MAX					
4.17	4.55	4.93	141.3	2.54	0.25	N/A	6%
HOOD DIMENSIONS (mm)							
SOCKET DIAMETERS AT ENTRANCE	TOLERANCE	OUT-OF ROUNDNESS	SOCKET DIAMETERS AT BOTTOM	OUT-OF ROUNDNESS	MINIMUM BELL LENGTH	MAXIMUM HOOD LENGTH	
142.6	0.25	2.54	141.55	2.54	102	130	

SCH40 PVC Conduit Bell End

AMMO#	Size	Wall Thickness	Lenght Feet	Bell Length	Feet per PKG
1/2-10-PVC-40-E	1/2	0.109	10	1.75	6000
3/4-10-PVC-40-E	3/4	0.113	10	2.25	4400
1-10-PVC-40-E	1	0.133	10	2.25	3,600
1-1/4-10-PVC-40-E	1-1/4	0.14	10	2.25	3,300
1-1/2-10-PVC-40-E	1-1/2	0.145	10	2.75	2,250
2-10-PVC-40-E	2	0.15	10	4.00	1,400
2-1/2-10-PVC-40-E	2-1/2	0.203	10	4.00	930
3-10-PVC-40-E	3	0.216	10	4.00	880
3-1/2-10-PVC-40-E	3-1/2	0.226	10	4.00	630
4-10-PVC-40-E	4	0.237	10	5.00	570
5-10-PVC-40-E	5	0.258	10	5.75	380
6-10-PVC-40-E	6	0.28	10	6.50	260
8-10-PVC-40-E	8	0.32	10	6.50	180

SCH80 PVC Conduit Bell End

AMMO#	Size	Minimum wall (T)	Lenght Feet	Bell Length	Feet per PKG
1/2-10-PVC-80-E	1/2	0.147	10	1.75	6,000
3/4-10-PVC-80-E	3/4	0.154	10	2.25	4,400
1-10-PVC-80-E	1	0.179	10	2.25	3,600
1-1/4-10-PVC-80-E	1-1/4	0.191	10	2.25	3,300
1-1/2-10-PVC-80-E	1-1/2	0.2	10	2.75	2,250
2-10-PVC-80-E	2	0.218	10	4.00	1,400
2-1/2-10-PVC-80-E	2-1/2	0.276	10	4.00	930
3-10-PVC-80-E	3	0.3	10	4.00	880
3-1/2-10-PVC-80-E	3-1/2	0.318	10	4.00	630
4-10-PVC-80-E	4	0.337	10	5.00	570
5-10-PVC-80-E	5	0.375	10	5.75	380
6-10-PVC-80-E	6	0.432	10	6.50	260
8-10-PVC-80-E	8	0.5	10	6.50	180

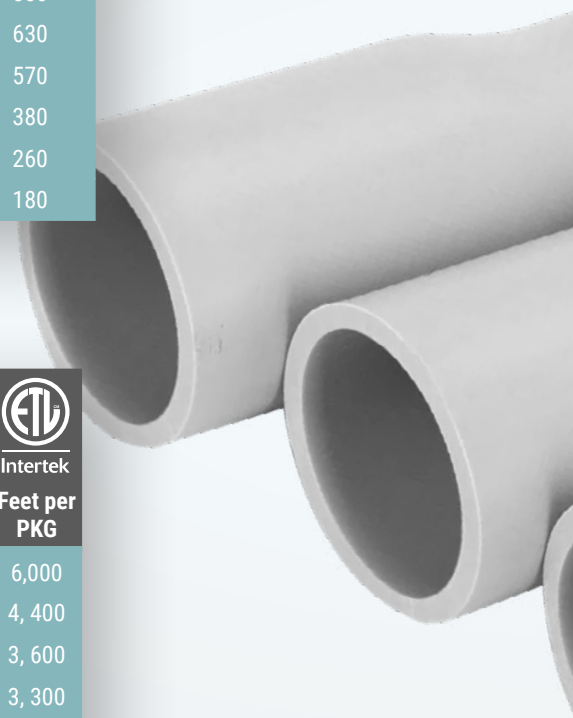

SCH40 PVC Conduit Bell End



Intertek

AMMO#	Size	Minimum wall (T)	Lenght Feet	Bell Length	Feet per PKG
1/2-20-PVC-40-E	1/2	0.109	20	1.75	12,000
3/4-20-PVC-40-E	3/4	0.113	20	2.25	8,800
1-20-PVC-40-E	1	0.133	20	2.25	7,200
1-1/4-20-PVC-40-E	1-1/4	0.14	20	2.25	6,600
1-1/2-20-PVC-40-E	1-1/2	0.145	20	2.75	4,500
2-20-PVC-40-E	2	0.15	20	4.00	2,800
2-1/2-20-PVC-40-E	2-1/2	0.203	20	4.00	1,860
3-20-PVC-40-E	3	0.216	20	4.00	1,760
3-1/2-20-PVC-40-E	3-1/2	0.226	20	4.00	1,260
4-20-PVC-40-E	4	0.237	20	5.00	1,140
5-20-PVC-40-E	5	0.258	20	5.75	760
6-20-PVC-40-E	6	0.280	20	6.50	520
8-20-PVC-40-E	8	0.322	20	6.50	360

SCH80 PVC Conduit Bell End



Intertek

AMMO#	Size	Minimum wall (T)	Lenght Feet	Bell Length	Feet per PKG
1/2-20-PVC-80-E	1/2	0.147	20	1.75	12,000
3/4-20-PVC-80-E	3/4	0.154	20	2.25	8,800
1-20-PVC-80-E	1	0.179	20	2.25	7,200
1-1/4-20-PVC-80-E	1-1/4	0.191	20	2.25	6,600
1-1/2-20-PVC-80-E	1-1/2	0.2	20	2.75	4,500
2-20-PVC-80-E	2	0.218	20	4.00	2,800
2-1/2-20-PVC-80-E	2-1/2	0.276	20	4.00	1,860
3-20-PVC-80-E	3	0.3	20	4.00	1,760
3-1/2-20-PVC-80-E	3-1/2	0.318	20	4.00	1,260
4-20-PVC-80-E	4	0.337	20	5.00	1,140
5-20-PVC-80-E	5	0.375	20	5.75	760
6-20-PVC-80-E	6	0.432	20	6.50	520
8-20-PVC-80-E	8	0.5	20	6.50	360

LL Type



AMMO#	SIZE	PKG
ARLLPVC-50	1/2"	5
ARLLPVC-75	3/4"	4
ARLLPVC-100	1"	4
ARLLPVC-125	1-1/4"	8
ARLLPVC-150	1-1/2"	10
ARLLPVC-200	2"	8

LB Type

AMMO#	SIZE	PKG
ARLBPVC-50	1/2"	25
ARLBPVC-75	3/4"	15
ARLBPVC-100	1"	10
ARLBPVC-125	1-1/4"	10
ARLBPVC-150	1-1/2"	10
ARLBPVC-200	2"	5
ARLBPVC-250	2-1/2"	5
ARLBPVC-300	3"	5



LR Type

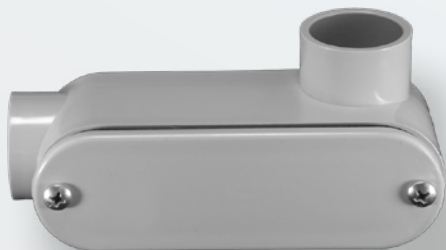

AMMO#	SIZE	PKG
ARLRPVC-50	1/2"	25
ARLRPVC-75	3/4"	15
ARLRPVC-100	1"	10
ARLRPVC-125	1-1/4"	10
ARLRPVC-150	1-1/2"	10
ARLRPVC-200	2"	5

C Type

AMMO#	SIZE	PKG
ARCB-50-PVC	1/2"	25
ARCB-75-PVC	3/4"	15
ARCB-100-PVC	1"	10
ARCB-125-PVC	1-1/4"	10
ARCB-150-PVC	1-1/2"	10
ARCB-200-PVC	2"	5



T Type

AMMO#	SIZE	PKG
ARTPVC-50	1/2"	25
ARTPVC-75	3/4"	15
ARTPVC-100	1"	10
ARTPVC-125	1-1/4"	10
ARTPVC-150	1-1/2"	10
ARTPVC-200	2"	5

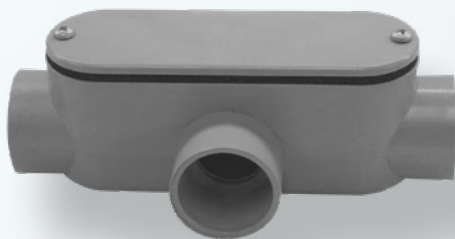

 PVC conduit bodies, made from durable polyvinyl chloride, are versatile components used in electrical and plumbing systems. They come in various shapes and sizes, like L-shaped and T-shaped, allowing for easy installation and maintenance of cables. PVC conduit bodies are lightweight, corrosion-resistant, and provide a secure, watertight seal when connected with PVC cement. They offer benefits such as impact resistance, weather resistance, and chemical resistance, ensuring durability in diverse environments. These non-conductive components are cost-effective alternatives to metal conduit bodies, promoting electrical safety. Choosing the right type and size is essential, following local codes for proper installation.



An elbow PVC bell-end conduit is a versatile electrical conduit fitting made of durable PVC, designed for protecting and routing electrical wiring. Its key features include a bell-end design for easy joining with other conduits, an elbow shape for directional changes, availability in various sizes, weatherproof and non-conductive properties, ease of installation, cost-effectiveness, and compliance with industry standards. This conduit is commonly used in electrical projects to ensure safety, durability, and flexibility in wiring installations.

45° Deg PVC Sch40 Elbow Plain End



45° Deg PVC Sch40 Elbow Bell End



AMMO#	SIZE	PKG
ARP40P-5045	1/2"	50
ARP40P-7545	3/4"	25
ARP40P-10045	1"	20
ARP40P-12545	1-1/4"	25
ARP40P-15045	1-1/2"	20
ARP40P-20045	2"	10
ARP40P-25045	2-1/2"	20
ARP40P-30045	3"	8
ARP40P-35045	3-1/2"	5
ARP40P-40045	4"	20
ARP40P-50045	5"	30
ARP40P-60045	6"	25
*ARP40P-80045	8"	1

AMMO#	SIZE	PKG
ARP40B-5045	1/2"	50
ARP40B-7545	3/4"	25
ARP40B-10045	1"	20
ARP40B-12545	1-1/4"	25
ARP40B-15045	1-1/2"	25
ARP40B-20045	2"	10
ARP40B-25045	2-1/2"	20
ARP40B-30045	3"	8
ARP40B-35045	3-1/2"	5
ARP40B-40045	4"	20
ARP40B-50045	5"	30
ARP40B-60045	6"	25
*ARP40B-80045	8"	1

*Non certification, in follow instructions UL directory

90° Deg PVC Sch40 Elbow Plain End



AMMO#	SIZE	PKG
ARP40P-5090	1/2"	50
ARP40P-7590	3/4"	35
ARP40P-10090	1"	20
ARP40P-12590	1-1/4"	30
ARP40P-15090	1-1/2"	30
ARP40P-20090	2"	15
ARP40P-25090	2-1/2"	18
ARP40P-30090	3"	14
ARP40P-35090	3-1/2"	12
ARP40P-40090	4"	10
ARP40P-50090	5"	30
ARP40P-60090	6"	25
*ARP40P-80090	8"	1

90° Deg PVC Sch40 Elbow Bell End



AMMO#	SIZE	PKG
ARP40B-5090	1/2"	50
ARP40B-7590	3/4"	35
ARP40B-10090	1"	20
ARP40B-12590	1-1/4"	30
ARP40B-15090	1-1/2"	30
ARP40B-20090	2"	15
ARP40B-25090	2-1/2"	18
ARP40B-30090	3"	14
ARP40B-35090	3-1/2"	12
ARP40B-40090	4"	10
ARP40B-50090	5"	30
ARP40B-60090	6"	25
*ARP40B-80090	8"	1

**Non certification, in follow
instructions UL directory*



Schedule 80 PVC Elbows:

Designed for heavy-duty applications with high-pressure requirements.

Feature thicker walls for superior strength and durability.

Highly resistant to a wide range of chemicals, acids, and bases.

Suitable for extreme temperature conditions.

Versatile, used in industrial plumbing, chemical processing, and more.

Offers a long service life, reducing maintenance costs.

45° Deg PVC Sch80 Elbow Plain End



45° Deg PVC Sch80 Elbow Bell End



AMMO#	SIZE	PKG
ARP80P-5045	1/2"	50
ARP80P-7545	3/4"	25
ARP80P-10045	1"	20
ARP80P-12545	1-1/4"	25
ARP80P-15045	1-1/2"	20
ARP80P-20045	2"	10
ARP80P-25045	2-1/2"	20
ARP80P-30045	3"	8
ARP80P-35045	3-1/2"	12
ARP80P-40045	4"	20
ARP80P-50045	5"	30
ARP80P-60045	6"	25
*ARP80P-80045	8"	1

AMMO#	SIZE	PKG
ARP80B-5045	1/2"	50
ARP80B-7545	3/4"	35
ARP80B-10045	1"	20
ARP80B-12545	1-1/4"	25
ARP80B-15045	1-1/2"	20
ARP80B-20045	2"	10
ARP80B-25045	2-1/2"	20
ARP80B-30045	3"	8
ARP80B-35045	3-1/2"	12
ARP80B-40045	4"	20
ARP80B-50045	5"	30
ARP80B-60045	6"	25
*ARP80B-80045	8"	1

**Non certification, in follow instructions UL directory*

90° Deg PVC Sch80 Elbow Plain End



AMMO#	SIZE	PKG
ARP80P-5090	1/2"	50
ARP80P-7590	3/4"	35
ARP80P-10090	1"	20
ARP80P-12590	1-1/4"	30
ARP80P-15090	1-1/2"	30
ARP80P-20090	2"	15
ARP80P-25090	2-1/2"	18
ARP80P-30090	3"	14
ARP80P-35090	3-1/2"	12
ARP80P-40090	4"	10
ARP80P-50090	5"	30
ARP80P-60090	6"	25
*ARP80P-80090	8"	1

90° Deg PVC Sch80 Elbow Bell End



AMMO#	SIZE	PKG
ARP80B-5090	1/2"	50
ARP80B-7590	3/4"	35
ARP80B-10090	1"	20
ARP80B-12590	1-1/4"	30
ARP80B-15090	1-1/2"	30
ARP80B-20090	2"	15
ARP80B-25090	2-1/2"	18
ARP80B-30090	3"	14
ARP80B-35090	3-1/2"	12
ARP80B-40090	4"	10
ARP80B-50090	5"	30
ARP80B-60090	6"	25
*ARP80B-80090	8"	1

**Non certification, in follow
instructions UL directory*

PVC Terminal Adapters Octagonal



AMMO#	SIZE	PKG
ARTA40PVC-50	1/2"	200
ARTA40PVC-75	3/4"	125
ARTA40PVC-100	1"	70
ARTA40PVC-125	1-1/4"	40
ARTA40PVC-150	1-1/2"	30
ARTA40PVC-200	2"	40
ARTA40PVC-250	2-1/2"	20
ARTA40PVC-300	3"	40



PVC Female Adapters

AMMO#	SIZE	PKG
ARFA40PVC-50	1/2"	200
ARFA40PVC-75	3/4"	125
ARFA40PVC-100	1"	70
ARFA40PVC-125	1-1/4"	40
ARFA40PVC-150	1-1/2"	30
ARFA40PVC-200	2"	40
ARFA40PVC-250	2-1/2"	20
ARFA40PVC-300	3"	40
ARFA40PVC-350	3-1/2"	30
ARFA40PVC-400	4"	20
ARFA40PVC-500	5"	10
ARFA40PVC-600	6"	8



PVC End Cap



AMMO#	SIZE	PKG
AREND40PVC-50	1/2"	100
AREND40PVC-75	3/4"	100
AREND40PVC-100	1"	50
AREND40PVC-125	1-1/4"	25
AREND40PVC-150	1-1/2"	25
AREND40PVC-200	2"	50
AREND40PVC-250	2-1/2"	25
AREND40PVC-300	3"	25

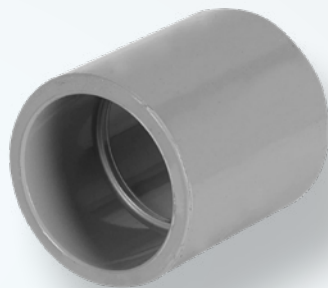

PVC Couplings

AMMO#	SIZE	PKG
ARCPVC40-50	1/2"	200
ARCPVC40-75	3/4"	125
ARCPVC40-100	1"	70
ARCPVC40-125	1-1/4"	40
ARCPVC40-150	1-1/2"	30
ARCPVC40-200	2"	40
ARCPVC40-250	2-1/2"	20
ARCPVC40-300	3"	40
ARCPVC40-350	3-1/2"	30
ARCPVC40-400	4"	20
ARCPVC40-500	5"	10
ARCPVC40-600	6"	8



Two Piece Expansion Coupling

AMMO#	SIZE	PKG
AREXP40PVC-50	1/2"	25
AREXP40PVC-75	3/4"	10
AREXP40PVC-100	1"	10
AREXP40PVC-125	1-1/4"	5
AREXP40PVC-150	1-1/2"	5
AREXP40PVC-200	2"	25
AREXP40PVC-250	2-1/2"	12
AREXP40PVC-300	3"	12
AREXP40PVC-350	3-1/2"	5
AREXP40PVC-400	4"	6



PVC Reducing Bushing



AMMO#	SIZE	PKG
AR40PVC-7550	3/4" X 1/2"	100
AR40PVC-10075	1" X 3/4"	100
AR40PVC-125100	1-1/4" X 1"	50
AR40PVC-150125	1-1/2" X 1-1/4"	50
AR40PVC-200150	2" X 1-1/2"	25
AR40PVC-250200	2-1/2" X 2"	25
AR40PVC-300200	3" x 2"	25
AR40PVC-300250	3" X 2-1/2"	25
AR40PVC-350300	3-1/2" X 3"	20
AR40PVC-400300	4" X 3"	20
AR40PVC-400350	4" X 3-1/2"	20



PVC Box Adapter



AMMO#	SIZE	PKG
ARBXPVC-50	1/2"	100
ARBXPVC-75	3/4"	100
ARBXPVC-100	1"	100
ARBXPVC-125	1-1/4"	50
ARBXPVC-150	1-1/2"	50
ARBXPVC-200	2"	25
ARBXPVC-250	2-1/2"	10
ARBXPVC-300	3"	10
ARBXPVC-350	3-1/2"	10
ARBXPVC-400	4"	10

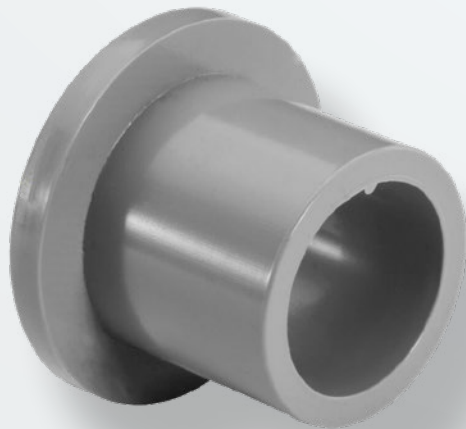

PVC Male Adapter

Circular



AMMO#	SIZE	PKG
ARMTA-50-PVC	1/2"	200
ARMTA-75-PVC	3/4"	125
ARMTA-100-PVC	1"	70
ARMTA-125-PVC	1-1/4"	40
ARMTA-150-PVC	1-1/2"	30
ARMTA-200-PVC	2"	40
*ARMTA-250-PVC	2-1/2"	20
*ARMTA-300-PVC	3"	40
*ARMTA-400-PVC	4"	20

*ETL listed



PVC Two Hole Pipe Straps



AMMO#	SIZE	PKG
ARTHSPVC-50	1/2"	300
ARTHSPVC-75	3/4"	200
ARTHSPVC-100	1"	200
ARTHSPVC-125	1-1/4"	200
ARTHSPVC-150	1-1/2"	200
ARTHSPVC-200	2"	200
ARTHSPVC-250	2-1/2"	100
ARTHSPVC-300	3"	100
ARTHSPVC-350	3-1/2"	100
ARTHSPVC-400	4"	100



PVC Offset



AMMO#	SIZE	PKG
AROF40PVC-50	1/2"	100
AROF40PVC-75	3/4"	100



Meter Offset

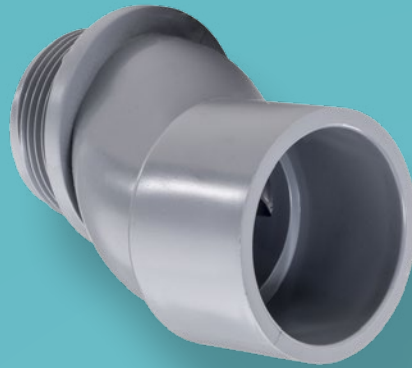

AMMO#	SIZE	PKG
AROFPVC40-125	1-1/4"	15
AROFPVC40-200	2"	8

Service Entrance Caps



AMMO#	SIZE	PKG
ARSPVC-125	1-1/4"	20
ARSPVC-150	1-1/2"	20
ARSPVC-200	2"	5
ARSPVC-250	2-1/2"	5



Combination Pull PVC



AMMO#	SIZE	MASTER
AREPE40PVC-75	3/4"	50



PVC Cement

AMMO#	SIZE	PKG
ARCEM-125	4OZ	24
ARCEM-250	8OZ	24
ARCEM-500	16OZ	12
ARCEM-1000	32OZ	12



Aluminum Conduit Bodies _____ 140
Mogul Conduit Bodies _____ 142
Rigid/IMC Combination Conduit Bodies _____ 144
EMT Conduit Bodies _____ 146
Malleable Iron Conduit Bodies _____ 148
Malleable Iron Form 7 Conduit Bodies _____ 150
Conduit Body Covers _____ 152

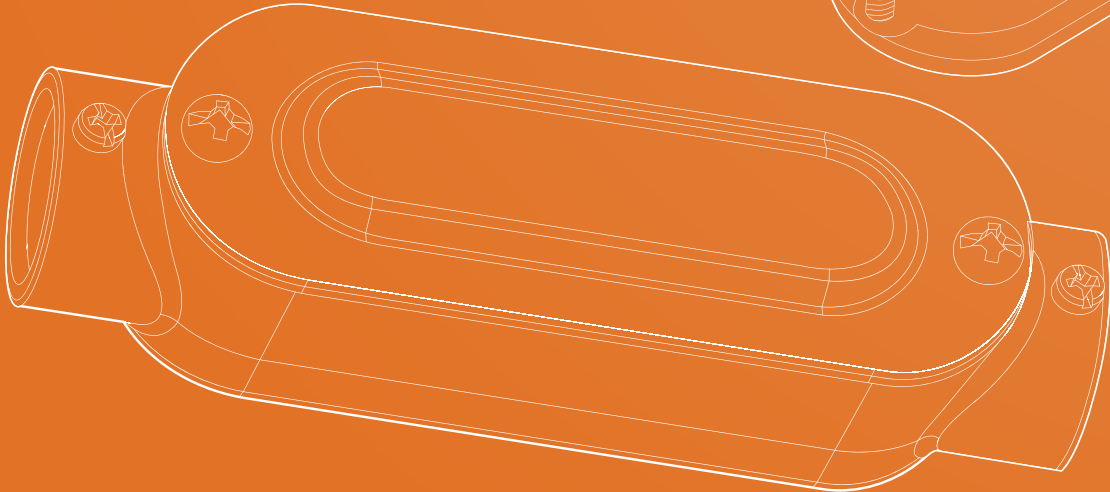
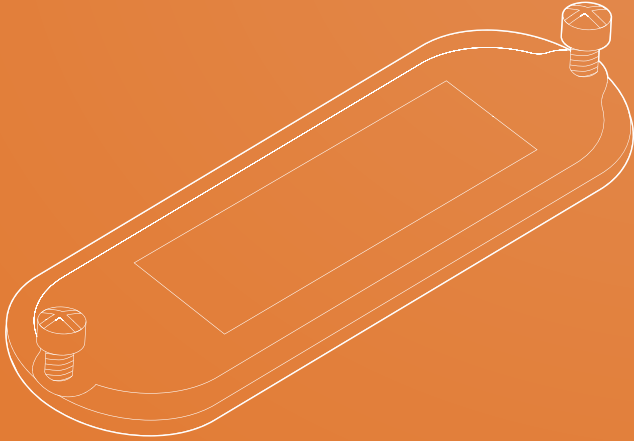
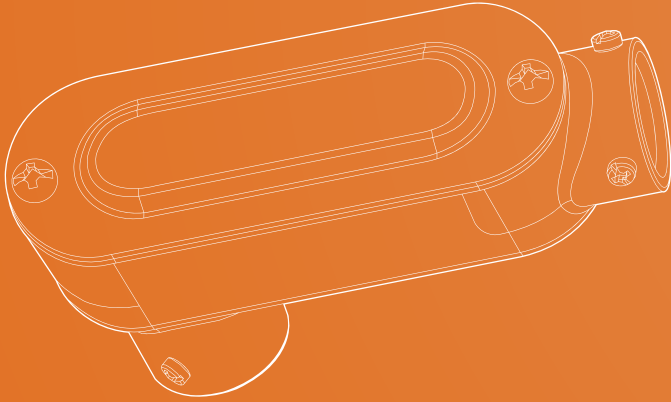



CONDUIT BODIES



Electrical Conduit Bodies

Aluminum
Die Cast



- *Versatile Connection: Joins Rigid Conduit or IMC, providing access for wire pulling, maintenance, additions, or splicing per National Electrical Code.*
- *Flexible Access: Threaded entrances and covers for multi-directional installation.*
- *Weatherproof: Powder-coated finish and gasket ensure durability.*

“LB” Type with Cover and Gasket



AMMO#	SIZE	PKG
ARLB-50CF	1/2"	50
ARLB-75CF	3/4"	50
ARLB-100CF	1"	25
ARLB-125CF	1-1/4"	10
ARLB-150CF	1-1/2"	10
ARLB-200CF	2"	10
ARLB-250CF	2-1/2"	1
ARLB-300CF	3"	1
ARLB-350CF	3-1/2"	1
ARLB-400CF	4"	1

“LL” Type with Cover and Gasket



AMMO#	SIZE	PKG
ARLL-50CF	1/2"	50
ARLL-75CF	3/4"	50
ARLL-100CF	1"	25
ARLL-125CF	1-1/4"	10
ARLL-150CF	1-1/2"	10
ARLL-200CF	2"	10
ARLL-250CF	2-1/2"	1
ARLL-300CF	3"	1
ARLL-350CF	3-1/2"	1
ARLL-400CF	4"	1



“LR” Type with Cover and Gasket



AMMO#	SIZE	PKG
ARLR-50CF	1/2"	50
ARLR-75CF	3/4"	50
ARLR-100CF	1"	25
ARLR-125CF	1-1/4"	10
ARLR-150CF	1-1/2"	10
ARLR-200CF	2"	5
ARLR-250CF	2-1/2"	1
ARLR-300CF	3"	1
ARLR-350CF	3-1/2"	1
ARLR-400CF	4"	1

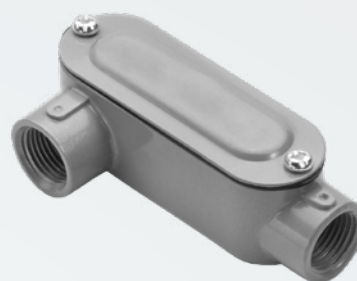

“C” Type with Cover and Gasket



AMMO#	SIZE	PKG
ARC-50CF	1/2"	50
ARC-75CF	3/4"	50
ARC-100CF	1"	25
ARC-125CF	1-1/4"	10
ARC-150CF	1-1/2"	10
ARC-200CF	2"	10
ARC-250CF	2-1/2"	1
ARC-300CF	3"	1
ARC-350CF	3-1/2"	1
ARC-400CF	4"	1



“T” Type with Cover and Gasket



AMMO#	SIZE	PKG
ART-50CF	1/2"	50
ART-75CF	3/4"	50
ART-100CF	1"	25
ART-125CF	1-1/4"	10
ART-150CF	1-1/2"	10
ART-200CF	2"	2
ART-250CF	2-1/2"	1
ART-300CF	3"	1
ART-350CF	3-1/2"	1
ART-400CF	4"	1

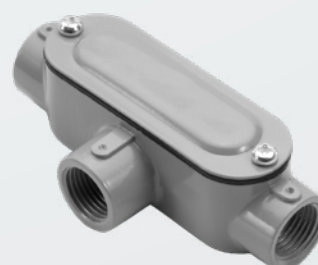

Mogul Conduit Bodies

Hot Dip Galvanized



Designed with wide and long openings, this product makes it easy to pull large and stiff conductors. It also facilitates efficient splicing and tapping operations, ensuring a smooth and streamlined workflow.

“LB” Type with Cover and Gasket



AMMO#	SIZE	PKG
ARMGLBR-100MI	1"	1
ARMGLBR-125MI	1-1/4"	1
ARMGLBR-150MI	1-1/2"	1
ARMGLBR-200MI	2"	1
ARMGLBR-250MI	2-1/2"	1
ARMGLBR-300MI	3"	1
ARMGLBR-350MI	3-1/2"	1
ARMGLBR-400MI	4"	1



“C” Type with Cover and Gasket



AMMO#	SIZE	PKG
ARMGCR-100MI	1"	1
ARMGCR-125MI	1-1/4"	1
ARMGCR-150MI	1-1/2"	1
ARMGCR-200MI	2"	1
ARMGCR-250MI	2-1/2"	1
ARMGCR-300MI	3"	1
ARMGCR-350MI	3-1/2"	1
ARMGCR-400MI	4"	1



“LL” Type with Cover and Gasket



AMMO#	SIZE	PKG
ARMGLLR-100MI	1"	1
ARMGLLR-125MI	1-1/4"	1
ARMGLLR-150MI	1-1/2"	1
ARMGLLR-200MI	2"	1
ARMGLLR-250MI	2-1/2"	1
ARMGLLR-300MI	3"	1
ARMGLLR-350MI	3-1/2"	1
ARMGLLR-400MI	4"	1



“LR” Type with Cover and Gasket



AMMO#	SIZE	PKG
ARMGLRR-100MI	1"	1
ARMGLRR-125MI	1-1/4"	1
ARMGLRR-150MI	1-1/2"	1
ARMGLRR-200MI	2"	1
ARMGLRR-250MI	2-1/2"	1
ARMGLRR-300MI	3"	1
ARMGLRR-350MI	3-1/2"	1
ARMGLRR-400MI	4"	1



“T” Type with Cover and Gasket



AMMO#	SIZE	PKG
ARMGTR-100MI	1"	1
ARMGTR-125MI	1-1/4"	1
ARMGTR-150MI	1-1/2"	1
ARMGTR-200MI	2"	1
ARMGTR-250MI	2-1/2"	1
ARMGTR-300MI	3"	1
ARMGTR-350MI	3-1/2"	1
ARMGTR-400MI	4"	1





Rigid / IMC Combination Conduit Bodies

Threaded
& Set Screw

“LB” Type with Cover and Gasket



AMMO#	SIZE	PKG
ARLBC-50CF	1/2"	50
ARLBC-75CF	3/4"	50
ARLBC-100CF	1"	25
ARLBC-125CF	1-1/4"	10
ARLBC-150CF	1-1/2"	10
ARLBC-200CF	2"	10
ARLBC-400CF	4"	1



“LL” Type with Cover and Gasket



AMMO#	SIZE	PKG
ARLLC-50CF	1/2"	100
ARLLC-75CF	3/4"	50
ARLLC-100CF	1"	25
ARLLC-125CF	1-1/4"	10
ARLLC-150CF	1-1/2"	10
ARLLC-200CF	2"	10



Die Cast Aluminum

CONDUIT BODIES

“LR” Type with Cover and Gasket



AMMO#	SIZE	PKG
ARLRC-50CF	1/2"	100
ARLRC-75CF	3/4"	50
ARLRC-100CF	1"	25
ARLRC-125CF	1-1/4"	10
ARLRC-150CF	1-1/2"	10
ARLRC-200CF	2"	5
ARLRC-300CF	3"	1



“T” Type with Cover and Gasket



AMMO#	SIZE	PKG
ARTC-50CF	1/2"	50
ARTC-75CF	3/4"	50
ARTC-100CF	1"	25
ARTC-125CF	1-1/4"	10
ARTC-150CF	1-1/2"	10
ARTC-200CF	2"	2



“C” Type with Cover and Gasket



AMMO#	SIZE	PKG
ARCC-50CF	1/2"	100
ARCC-75CF	3/4"	50
ARCC-100CF	1"	25
ARCC-125CF	1-1/4"	25
ARCC-150CF	1-1/2"	10
ARCC-200CF	2"	5



Designed with wide and long openings, this product makes it easy to pull large and stiff conductors. It also facilitates efficient splicing and tapping operations, ensuring a smooth and streamlined workflow.

EMT Conduit Bodies Non-Threaded & Set Screw

Enables conductor installation, directional changes, splicing, branch connections, and future maintenance access.

“LB” Type with Cover and Gasket

AMMO#	SIZE	PKG
ARLBE-50CF	1/2"	50
ARLBE-75CF	3/4"	50
ARLBE-100CF	1"	25
ARLBE-125CF	1-1/4"	10
ARLBE-150CF	1-1/2"	10
ARLBE-200CF	2"	10
ARLBE-250CF	2-1/2"	1
ARLBE-300CF	3"	1
ARLBE-350CF	3-1/2"	1
ARLBE-400CF	4"	1

“LL” Type with Cover and Gasket

AMMO#	SIZE	PKG
ARLLE-50CF	1/2"	100
ARLLE-75CF	3/4"	50
ARLLE-100CF	1"	25
ARLLE-125CF	1-1/4"	10
ARLLE-150CF	1-1/2"	10
ARLLE-200CF	2"	10
ARLLE-250CF	2-1/2"	1
ARLLE-300CF	3"	1
ARLLE-350CF	3-1/2"	1
ARLLE-400CF	4"	1

“LR” Type with Cover and Gasket

AMMO#	SIZE	PKG
ARLRE-50CF	1/2"	50
ARLRE-75CF	3/4"	50
ARLRE-100CF	1"	25
ARLRE-125CF	1-1/4"	25
ARLRE-150CF	1-1/2"	10
ARLRE-200CF	2"	10
ARLRE-250CF	2-1/2"	1
ARLRE-300CF	3"	1
ARLRE-350CF	3-1/2"	1
ARLRE-400CF	4"	1



Die Cast Aluminum

“C” Type with Cover and Gasket



AMMO#	SIZE	PKG
ARCE-50CF	1/2"	100
ARCE-75CF	3/4"	50
ARCE-100CF	1"	25
ARCE-125CF	1-1/4"	25
ARCE-150CF	1-1/2"	10
ARCE-200CF	2"	5
ARCE-250CF	2-1/2"	1
ARCE-300CF	3"	1
ARCE-350CF	3-1/2"	1
ARCE-400CF	4"	1



“T” Type with Cover and Gasket



AMMO#	SIZE	PKG
ARTE-50CF	1/2"	50
ARTE-75CF	3/4"	50
ARTE-100CF	1"	25
ARTE-125CF	1-1/4"	10
ARTE-150CF	1-1/2"	10
ARTE-200CF	2"	2
ARTE-250CF	2-1/2"	1
ARTE-300CF	3"	1
ARTE-350CF	3-1/2"	1
ARTE-400CF	4"	1



Covers



AMMO#	SIZE	PKG
ARCF-50	1/2"	250
ARCF-75	3/4"	200
ARCF-100	1"	100
ARCF-125/150	1-1/4"-1- 1/2"	50
ARCF-200	2"	50
ARCF-250/300	2-1/2" - 3"	20
ARCF-350/400	3-1/2" - 4"	10



Gasket



AMMO#	SIZE	PKG
ARSGN-50	1/2"	250
ARSGN-75	3/4"	200
ARSGN-100	1"	100
ARSGN-125/150	1-1/4" - 1- 1/2"	50
ARSGN-200	2"	50
ARSGN-250/300	2-1/2" - 3"	20
ARSGN-350/400	3-1/2" - 4"	10



Threaded Conduit Bodies

Form 5
Malleable Iron



Provides convenient access for pulling, splicing, and maintenance of conductors, featuring a threaded design compatible with both rigid conduit and IMC.

“LB” Type

AMMO#	SIZE	PKG
ARLB-50MI	1/2"	10
ARLB-75MI	3/4"	10
ARLB-100MI	1"	5
ARLB-125MI	1-1/4"	5
ARLB-150MI	1-1/2"	5
ARLB-200MI	2"	5
ARLB-250MI	2-1/2"	1
ARLB-300MI	3"	1
ARLB-350MI	3-1/2"	1
ARLB-400MI	4"	1

“LL” Type

AMMO#	SIZE	PKG
ARLL-50MI	1/2"	10
ARLL-75MI	3/4"	10
ARLL-100MI	1"	5
ARLL-125MI	1-1/4"	5
ARLL-150MI	1-1/2"	5
ARLL-200MI	2"	5
ARLL-250MI	2-1/2"	1
ARLL-300MI	3"	1
ARLL-350MI	3-1/2"	1
ARLL-400MI	4"	1



“LR” Type

AMMO#	SIZE	PKG
ARLR-50MI	1/2"	10
ARLR-75MI	3/4"	10
ARLR-100MI	1"	5
ARLR-125MI	1-1/4"	5
ARLR-150MI	1-1/2"	5
ARLR-200MI	2"	5
ARLR-250MI	2-1/2"	1
ARLR-300MI	3"	1
ARLR-350MI	3-1/2"	1
ARLR-400MI	4"	1

“C” Type

AMMO#	SIZE	PKG
ARC-50MI	1/2"	10
ARC-75MI	3/4"	10
ARC-100MI	1"	5
ARC-125MI	1-1/4"	5
ARC-150MI	1-1/2"	2
ARC-200MI	2"	1
ARC-250MI	2-1/2"	1
ARC-300MI	3"	1
ARC-350MI	3-1/2"	1
ARC-400MI	4"	1

“T” Type

AMMO#	SIZE	PKG
ART-50MI	1/2"	10
ART-75MI	3/4"	10
ART-100MI	1"	5
ART-125MI	1-1/4"	5
ART-150MI	1-1/2"	2
ART-200MI	2"	1
ART-250MI	2-1/2"	1
ART-300MI	3"	1
ART-350MI	3-1/2"	1
ART-400MI	4"	1



Cover & Gasket

AMMO#	SIZE	PKG
ARCG-50MI	1/2"	100
ARCG-75MI	3/4"	100
ARCG-100MI	1"	50
ARCG-125/150MI	1-1/4"-1-1/2"	25
ARCG-200MI	2"	25
ARCG-250/300MI	2-1/2"-3"	10
ARCG-350/400MI	3-1/2"-4"	10





Rigid Conduit Bodies Form 7 Gray Iron

 To ensure convenient access for the pulling, splicing, and maintenance of conductors, enhancing overall efficiency and reliability.

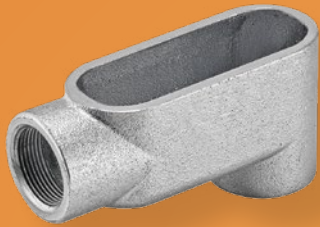

“LB” Type

AMMO#	SIZE	PKG
ARRLB-50G7	1/2"	10
ARRLB-75G7	3/4"	10
ARRLB-100G7	1"	5
ARRLB-125G7	1-1/4"	5
ARRLB-150G7	1-1/2"	5
ARRLB-200G7	2"	5
ARRLB-250G7	2-1/2"	1
ARRLB-300G7	3"	1
ARRLB-350G7	3-1/2"	1
ARRLB-400G7	4"	1



“LL” Type

AMMO#	SIZE	PKG
ARRLL-50G7	1/2"	10
ARRLL-75G7	3/4"	10
ARRLL-100G7	1"	5
ARRLL-125G7	1-1/4"	5
ARRLL-150G7	1-1/2"	5
ARRLL-200G7	2"	5
ARRLL-250G7	2-1/2"	1
ARRLL-300G7	3"	1
ARRLL-350G7	3-1/2"	1
ARRLL-400G7	4"	1



“LR” Type

AMMO#	SIZE	PKG
ARRLR-50G7	1/2"	10
ARRLR-75G7	3/4"	10
ARRLR-100G7	1"	5
ARRLR-125G7	1-1/4"	10
ARRLR-150G7	1-1/2"	10
ARRLR-200G7	2"	5
ARRLR-250G7	2-1/2"	1
ARRLR-300G7	3"	1
ARRLR-350G7	3-1/2"	1
ARRLR-400G7	4"	1



“C” Type

AMMO#	SIZE	PKG
ARRLC-50G7	1/2"	10
ARRLC-75G7	3/4"	10
ARRLC-100G7	1"	5
ARRLC-125G7	1-1/4"	5
ARRLC-150G7	1-1/2"	5
ARRLC-200G7	2"	5
ARRLC-250G7	2-1/2"	1
ARRLC-300G7	3"	1
ARRLC-350G7	3-1/2"	1
ARRLC-400G7	4"	1



“T” Type

AMMO#	SIZE	PKG
ARRLT-50G7	1/2"	10
ARRLT-75G7	3/4"	10
ARRLT-100G7	1"	5
ARRLT-125G7	1-1/4"	5
ARRLT-150G7	1-1/2"	5
ARRLT-200G7	2"	5
ARRLT-250G7	2-1/2"	1
ARRLT-300G7	3"	1
ARRLT-350G7	3-1/2"	1
ARRLT-400G7	4"	1



Rigid Conduit Covers Form 7 Gray Iron

 To ensure convenient access for the pulling, splicing, and maintenance of conductors, enhancing overall efficiency and reliability.

Iron Cover with Integral Gasket

AMMO#	SIZE	PKG
ARCBC-50GLT	1/2"	10
ARCBC-75GLT	3/4"	10
ARCBC-100GLT	1"	5
ARCBC-125GLT	1-1/4"	5
ARCBC-150GLT	1-1/2"	5
ARCBC-200GLT	2"	5
ARCBC-250/300GLT	2-1/2"-3"	1
ARCBC-350/400GLT	3"-1/2"-4"	1

Steel Cover with Integral Gasket

AMMO#	SIZE	PKG
ARCBC-50S	1/2"	10
ARCBC-75S	3/4"	10
ARCBC-100S	1"	5
ARCBC-125S	1-1/4"	5
ARCBC-150S	1-1/2"	5
ARCBC-200S	2"	5
ARCBC-250/300S	2-1/2"-3"	1
ARCBC-350/400S	3"-1/2"-4"	1



CONDUIT BODIES

152

Conduit Body Covers Malleable Iron Galvanized Steel Screws



Durable and corrosion-resistant, this product is ideal for wet locations with a gasket. Includes screws and meets Form 5 standards.



AMMO#	SIZE	INNER	MASTER
ARMHDG-50MI	1/2"	40	400
ARMHDG-75MI	3/4"	40	400
ARMHDG-100MI	1"	25	250
ARMHDG-125/150MI	1-1/4"-1-1/2"	20	200
ARMHDG-200MI	2"	10	100
ARMHDG-250/300MI	2-1/2" - 3"	5	50
ARMHDG-350/400MI	3-1/2" - 4"	-	10



Conduit Body Covers Form 7 Gray Iron



Raised dome provides extra wiring room, features captive steel screws, and is designed to cover conduit body openings.



AMMO#	SIZE	PKG
ARCBC-50G	1/2"	100
ARCBC-75G	3/4"	100
ARCBC-100G	1"	50
ARCBC-125G	1-1/4"	25
ARCBC-150G	1-1/2"	20
ARCBC-200G	2"	20
ARCBC-250/300G	2-1/2" - 3"	10
ARCBC-350/400G	3"-1/2" - 4"	10



EMT Connectors & Couplings _____	156
AC, MC, BX, Flex and NM Connectors _____	168
Bushings _____	183
Nylon Liquid Tight Connectors _____	184
Liquid Tight Connectors _____	186
Liquid Tight Malleable Iron Connectors _____	188
Rigid Connectors & Couplings _____	192
Grounding Bushings _____	196
Reducing Bushings _____	198
Plastic Bushings _____	199
Conduit Supports _____	200
Watertight Hubs _____	204
Locknuts _____	205
Chase Nipples _____	206
Offset Nipples _____	207
Strap EMT & BX _____	208
Straps Rigid _____	210
Metal Cable Staples _____	211
Insulated Connectors _____	212
Electrical Tape _____	216
Wire Connectors _____	217
Cable Ties _____	218

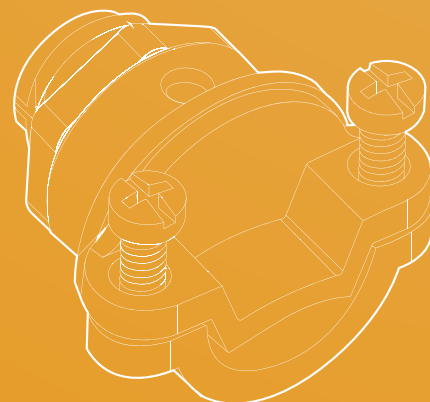
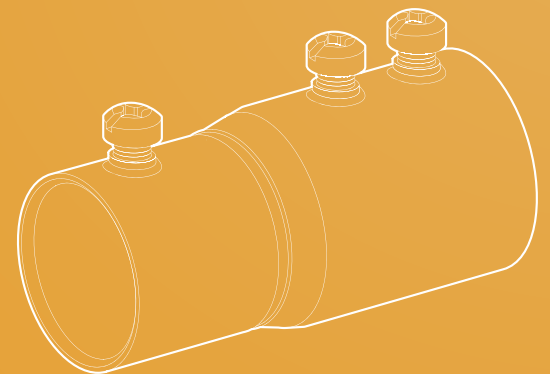



ELECTRICAL FITTINGS



EMT Connectors & Couplings

EMT Connectors Set Screw Steel



AMMO#	SIZE	INNER	MASTER
ARSCNS-50	1/2"	50	500
ARSCNS-75	3/4"	25	250
ARSCNS-100	1"	20	200
ARSCNS-125	1-1/4"	-	25
ARSCNS-150	1-1/2"	-	25
ARSCNS-200	2"	-	20
ARSCNS-250	2-1/2"	-	12
ARSCNS-300	3"	-	12
ARSCNS-350	3-1/2"	-	6
ARSCNS-400	4"	-	6



EMT Connectors Set Screw Insulated Steel



AMMO#	SIZE	INNER	MASTER
ARSCNS-50I	1/2"	50	500
ARSCNS-75I	3/4"	25	250
ARSCNS-100I	1"	20	200
ARSCNS-125I	1-1/4"	-	25
ARSCNS-150I	1-1/2"	-	25
ARSCNS-200I	2"	-	20
ARSCNS-250I	2-1/2"	-	12
ARSCNS-300I	3"	-	12
ARSCNS-350I	3-1/2"	-	6
ARSCNS-400I	4"	-	6





EMT Connectors Set Screw Zinc



AMMO#	SIZE	PKG
ARSCNZ-50	1/2"	500
ARSCNZ-75	3/4"	250
ARSCNZ-100	1"	200
ARSCNZ-125	1-1/4"	25
ARSCNZ-150	1-1/2"	25
ARSCNZ-200	2"	20
ARSCNZ-250	2-1/2"	12
ARSCNZ-300	3"	12
ARSCNZ-350	3-1/2"	10
ARSCNZ-400	4"	6

EMT Connectors Set Screw Insulated Zinc



AMMO#	SIZE	PKG
ARSCNZ-50I	1/2"	500
ARSCNZ-75I	3/4"	250
ARSCNZ-100I	1"	200
ARSCNZ-125I	1-1/4"	25
ARSCNZ-150I	1-1/2"	25
ARSCNZ-200I	2"	20
ARSCNZ-250I	2-1/2"	12
ARSCNZ-300I	3"	12
ARSCNZ-350I	3-1/2"	10
ARSCNZ-400I	4"	6

EMT Slip Couplings Set Screw

AMMO#	SIZE	INNER	MASTER
ARSL50G	1/2"	50	500
ARSL75G	3/4"	25	250
ARSL100G	1"	10	100
ARSL125G	1-1/4"	-	25
ARSL150G	1-1/2"	-	25
ARSL200G	2"	-	20
ARSL250G	2-1/2"	-	12
ARSL300G	3"	-	12
ARSL350G	3-1/2"	-	6
ARSL400G	4"	-	6



Combination Couplings EMT to Rigid



AMMO#	SIZE	INNER	MASTER
ARCCSR-50	1/2"	25	250
ARCCSR-75	3/4"	10	100
ARCCSR-100	1"	10	100



EMT Couplings Set Screw Steel



AMMO#	SIZE	INNER	MASTER
ARSCPS-50	1/2"	50	500
ARSCPS-75	3/4"	25	250
ARSCPS-100	1"	10	100
ARSCPS-125	1-1/4"	-	25
ARSCPS-150	1-1/2"	-	25
ARSCPS-200	2"	-	20
ARSCPS-250	2-1/2"	-	12
ARSCPS-300	3"	-	12
ARSCPS-350	3-1/2"	-	6
ARSCPS-400	4"	-	6



EMT Connectors Set Screw Zinc



AMMO#	SIZE	PKG
ARSCPZ-50	1/2"	500
ARSCPZ-75	3/4"	250
ARSCPZ-100	1"	200
ARSCPZ-125	1-1/4"	25
ARSCPZ-150	1-1/2"	25
ARSCPZ-200	2"	20
ARSCPZ-250	2-1/2"	12
ARSCPZ-300	3"	12
ARSCPZ-350	3-1/2"	10
ARSCPZ-400	4"	6



EMT Compression Connectors Steel



AMMO#	SIZE	INNER	MASTER
ARCCNS-50	1/2"	25	250
ARCCNS-75	3/4"	25	250
ARCCNS-100	1"	10	100
ARCCNS-125	1-1/4"	-	25
ARCCNS-150	1-1/2"	-	20
ARCCNS-200	2"	-	15
ARCCNS-250	2-1/2"	-	12
ARCCNS-300	3"	-	6
ARCCNS-350	3-1/2"	-	6
ARCCNS-400	4"	-	6



EMT Compression Connectors Insulated Steel



AMMO#	SIZE	INNER	MASTER
ARCCNS-50I	1/2"	25	250
ARCCNS-75I	3/4"	25	250
ARCCNS-100I	1"	10	100
ARCCNS-125I	1-1/4"	-	25
ARCCNS-150I	1-1/2"	-	20
ARCCNS-200I	2"	-	15
ARCCNS-250I	2-1/2"	-	12
ARCCNS-300I	3"	-	6
ARCCNS-350I	3-1/2"	-	6
ARCCNS-400I	4"	-	6



EMT Compression Connectors Zinc Die Cast

AMMO#	SIZE	INNER	MASTER
ARCCNZ-50	1/2"	50	500
ARCCNZ-75	3/4"	25	250
ARCCNZ-100	1"	10	100
ARCCNZ-125	1-1/4"	-	25
ARCCNZ-150	1-1/2"	-	20
ARCCNZ-200	2"	-	15
ARCCNZ-250	2-1/2"	-	12
ARCCNZ-300	3"	-	6
ARCCNZ-350	3-1/2"	-	6
ARCCNZ-400	4"	-	6



EMT Compression Connectors Insulated Zinc

AMMO#	SIZE	INNER	MASTER
ARCCNZ-50I	1/2"	50	500
ARCCNZ-75I	3/4"	25	250
ARCCNZ-100I	1"	10	100
ARCCNZ-125I	1-1/4"	-	25
ARCCNZ-150I	1-1/2"	-	20
ARCCNZ-200I	2"	-	15
ARCCNZ-250I	2-1/2"	-	12
ARCCNZ-300I	3"	-	6
ARCCNZ-350I	3-1/2"	-	6
ARCCNZ-400I	4"	-	6



EMT Compression Couplings Steel



EMT Compression Couplings Zinc Die Cast

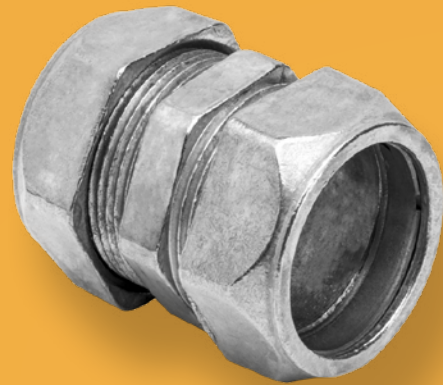

AMMO#	SIZE	INNER	MASTER
ARCCPS-50	1/2"	25	250
ARCCPS-75	3/4"	25	250
ARCCPS-100	1"	10	100
ARCCPS-125	1-1/4"	-	25
ARCCPS-150	1-1/2"	-	20
ARCCPS-200	2"	-	15
ARCCPS-250	2-1/2"	-	6
ARCCPS-300	3"	-	6
ARCCPS-350	3-1/2"	-	6
ARCCPS-400	4"	-	6

AMMO#	SIZE	INNER	MASTER
ARCCPZ-50	1/2"	50	500
ARCCPZ-75	3/4"	25	250
ARCCPZ-100	1"	50	200
ARCCPZ-125	1-1/4"	-	25
ARCCPZ-150	1-1/2"	-	20
ARCCPZ-200	2"	-	15

EMT Compression Connectors Raintight Steel



AMMO#	SIZE	INNER	MASTER
ARCCNRS-50	1/2"	25	250
ARCCNRS-75	3/4"	25	250
ARCCNRS-100	1"	10	100
ARCCNRS-125	1-1/4"	5	25
ARCCNRS-150	1-1/2"	2	20
ARCCNRS-200	2"	-	15
ARCCNRS-250	2-1/2"	-	12
ARCCNRS-300	3"	-	6
ARCCNRS-350	3-1/2"	-	5
ARCCNRS-400	4"	-	3



EMT Compression Connectors Raintight Insulated Steel



AMMO#	SIZE	INNER	MASTER
ARCCNRS-50I	1/2"	25	250
ARCCNRS-75I	3/4"	25	250
ARCCNRS-100I	1"	10	100
ARCCNRS-125I	1-1/4"	5	25
ARCCNRS-150I	1-1/2"	2	20
ARCCNRS-200I	2"	2	15
ARCCNRS-250I	2-1/2"	-	12
ARCCNRS-300I	3"	-	6
ARCCNRS-350I	3-1/2"	-	5
ARCCNRS-400I	4"	-	3



EMT Compression Couplings Raintight Steel



AMMO#	SIZE	INNER	MASTER
ARCCPRS-50	1/2"	25	250
ARCCPRS-75	3/4"	25	250
ARCCPRS-100	1"	10	100
ARCCPRS-125	1-1/4"	-	25
ARCCPRS-150	1-1/2"	-	20
ARCCPRS-200	2"	-	15
ARCCPRS-250	2-1/2"	-	12
ARCCPRS-300	3"	-	6
ARCCPRS-350	3-1/2"	-	5
ARCCPRS-400	4"	-	3

Combination Couplings EMT to Flex



Zinc Die Cast

AMMO#	SIZE	INNER	MASTER
ARCPSNM-5038	3/8"-1/2"	50	500



Top-Bite Combination Couplings EMT Set Screw to Flex

Zinc Plated Steel

AMMO#	SIZE	PKG
ARCPSCB-38	3/8"	250
ARCPSCB-50	1/2"	125
ARCPSCB-75	3/4"	100



Top-Bite Combination Couplings EMT Compression to Flex

Zinc Plated Steel

AMMO#	SIZE	PKG
ARCPSCB-38F	3/8"	125
ARCPSCB-50F	1/2"	125
ARCPSCB-75F	3/4"	100



EMT and Rigid Combo to Box Zinc Die Cast



AMMO#	SIZE	INNER	MASTER
ARSTERZ-50	1/2"	10	100
ARSTERZ-75	3/4	5	50
ARSTERZ-100	1"		25
ARSTERZ-125	1-1/4"		20



EMT to Box Set Screws Zinc Die Cast



AMMO#	SIZE	INNER	MASTER
ARSTEBZ-50	1/2"	10	100
ARSTEBZ-75	3/4	5	50



Combination Pull Elbows Steel Zinc Die Cast



AMMO#	SIZE	INNER	MASTER
ARPECO-50	1/2"	10	100
ARPECO-75	3/4	5	50
ARPECO-100	1"		25



EMT 90° Compression Connectors



Zinc Die Cast

AMMO#	SIZE	INNER	MASTER
ARCCNS90-50	1/2"	25	250
ARCCNS90-75	3/4"	20	200
ARCCNS90-100	1"	10	100



EMT to Inside Corner Set Screws



Zinc Die Cast

AMMO#	SIZE	INNER	MASTER
ARSSINCOR-50	1/2"	10	100
ARSSINCOR-75	3/4"	5	50



EMT to Box Offset Compression Connectors



Zinc Die Cast

AMMO#	SIZE	INNER	MASTER
ARCPZC-50	1/2"	20	200
ARCPZC-75	3/4"	10	100

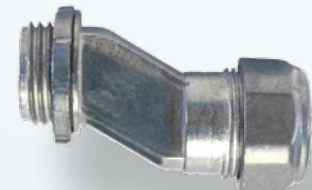

EMT Offset Connectors Set Screw Type



Zinc Die Cast

AMMO#	SIZE	INNER	MASTER
AROFC-50	1/2"	10	100
AROFC-75	3/4"	10	100
AROFC-100	1"	10	100

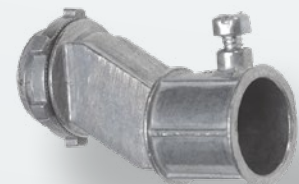

EMT to Liquidtight Compression Couplings Steel



AMMO#	SIZE	INNER	MASTER
ARCELT-50	1/2"	25	250
ARCELT-75	3/4"	20	200
ARCELT-100	1"	10	100



EMT to Rigid Compression Couplings Steel



AMMO#	SIZE	INNER	MASTER
ARCER-50	1/2"	20	200
ARCER-75	3/4"	10	100
ARCER-100	1"	10	100



AC, MC, BX, Flex, & NM Connectors



AMMO #	SIZE	TYPE	INNER	MASTER
ARBX-38	3/8"	Connectors BX Zinc	50	500
ARFDS-38	3/8"	BX-Flex Duplex Connectors Zinc	25	250
ARDC3890	3/8"	Duplex Connectors 90° for BX, Flex, NM & MC Cable	25	250
ARSSBXZ-5038	1/2" - 3/8"	Coupling EMT to BX Zinc Die Cast	25	250
ARSCBF-38MI	3/8"	Malleable Duplex Connector	10	100
ARBXFC-3845	3/8"	45° Squeeze Type Bx-Flex Connector	50	500
ARSCBF-38ZC	3/8"	Combination Cable Connector 2 Screw Clamp Type	100	1000



ARBX-38



ARFDS-38



ARDC3890



ARSSBXZ-5038



ARSCBF-38MI



ARBXFC-3845



ARSCBF-38ZC

**Cable Connectors
BX-Flex NM & MC
Steel**

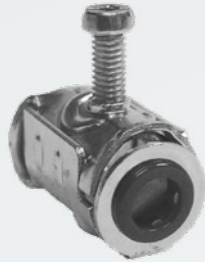

AMMO#	SIZE	INNER	MASTER
ARMC-50	1/2"	25	250

**Connectors BX-Flex
Set Screw Type
Steel**



AMMO#	SIZE	PKG
ARMCD-50	1/2"	25

**Flex Metallic
Connectors
Zinc Die Cast**



AMMO#	SIZE	INNER	MASTER
ARFSC-38	3/8"	50	500

**Flex Metal Single
Connectors
Zinc Die Cast**



AMMO#	SIZE	INNER	MASTER
ARFSS-38	3/8"	25	250

**Flex Metal Single
Screw Connectors
Zinc Die Cast**



AMMO#	SIZE	INNER	MASTER
ARSG-3838	3/8"	10	100

**Armored Cable
Fittings
Zinc Die Cast**



AMMO#	SIZE	INNER	MASTER
ARMCN-38	3/8"	100	1000
ARMCN-50	1/2"	25	250
ARMCN-75	3/4"	25	250

Armored Cable Fittings Steel



AMMO#	SIZE	PKG
ARTBSC-38I	3/8"	100
ARTBSC-50I	1/2"	100
ARTBSC-75I	3/4"	50
ARTBSC-100I	1"	25
ARTBSC-125I	1-1/4"	25
ARTBSC-150I	1-1/2"	10
ARTBSC-200I	2"	5
ARTBSC-250I	2-1/2"	4
ARTBSC-300I	3"	5
ARTBSC-350I	3-1/2"	1
ARTBSC-400I	4"	1

AMMO#	SIZE	PKG
ARFCNS-38	3/8"	500
ARFCNS-50	1/2"	250
ARFCNS-75	3/4"	250
ARFCNS-100	1"	100
ARFCNS-125	1-1/4"	100
ARFCNS-150	1-1/2"	50
ARFCNS-200	2"	40
ARFCNS-250	2-1/2"	10
ARFCNS-300	3"	10
ARFCNS-350	3-1/2"	1
ARFCNS-400	4"	1

Cable Connectors NM Sheathed Plastic 105° Polypropylene



AMMO#	SIZE	INNER	MASTER
ARCR50	1/2"	100	1000
ARCR75	3/4"	50	500

Flex AC MC Straight Squeeze Type Connectors Zinc Die Cast



Straight Liquidtight
Squeeze Type Connectors
with Insulated Throat
with Insulated Throat



AMMO#	SIZE	INNER	MASTER
ARFCNS-50I	1/2"	25	250
ARFCNS-75I	3/4"	25	250
ARFCNS-100I	1"	10	100
ARFCNS-125I	1-1/4"	10	100
ARFCNS-150I	1-1/2"	5	50
ARFCNS-200I	2"	10	40

Straight Squeeze Type
Connectors
Malleable Iron



AMMO#	SIZE	INNER	MASTER
ARFCNS-38MI	3/8"	25	250
ARFCNS-50MI	1/2"	25	250
ARFCNS-75MI	3/4"	25	250
ARFCNS-100MI	1"	10	100
ARFCNS-125MI	1-1/4"	10	100
ARFCNS-150MI	1-1/2"	5	50
ARFCNS-200MI	2"	-	20
ARFCNS-250MI	2-1/2"	-	10
ARFCNS-300MI	3"	-	2
ARFCNS-350MI	3-1/2"	-	1
ARFCNS-400MI	4"	-	1

Straight Insulated
Squeeze Type
BX-Flex Connectors
Malleable Iron



AMMO#	SIZE	INNER	MASTER
ARFCNS-38TMI	3/8"	25	250
ARFCNS-50TMI	1/2"	25	250
ARFCNS-75TMI	3/4"	10	250
ARFCNS-100TMI	1"	10	100
ARFCNS-125TMI	1-1/4"	5	100
ARFCNS-150TMI	1-1/2"	-	50
ARFCNS-200TMI	2"	-	20
ARFCNS-250TMI	2-1/2"	-	10
ARFCNS-300TMI	3"	-	2
ARFCNS-350TMI	3-1/2"	-	1
ARFCNS-400TMI	4"	-	1

90° Insulated Throat
Squeeze Type
BX-Flex Connectors
Zinc Die Cast



AMMO#	SIZE	INNER	MASTER
ARFCSQ90-38IT	3/8"	50	500
ARFCSQ90-50IT	1/2"	25	250
ARFCSQ90-75IT	3/4"	10	100
ARFCSQ90-100IT	1"	5	50
ARFCSQ90-125IT	1-1/4"	10	40
ARFCSQ90-150IT	1-1/2"	10	5
ARFCSQ90-200IT	2"	-	5

BX-Flex Connectors
Squeeze Type 90°
Zinc Die Cast



AMMO#	SIZE	INNER	MASTER
ARFCN90-38	3/8"	50	500
ARFCN90-50	1/2"	25	250
ARFCN90-75	3/4"	10	100
ARFCN90-100	1"	5	50
ARFCN90-125	1-1/4"	10	40
ARFCN90-150	1-1/2"	-	5
ARFCN90-200	2"	-	5
ARFCN90-250	2-1/2"	-	5
ARFCN90-300	3"	-	2
ARFCN90-350	3-1/2"	-	1
ARFCN90-400	4"	-	1

BX-Flex Connectors
Squeeze Type 90°
Malleable Iron



AMMO#	SIZE	INNER	MASTER
ARDC-3890MI	3/8"	50	500
ARDC-5090MI	1/2"	25	250
ARDC-7590MI	3/4"	10	100
ARDC-10090MI	1"	5	50
ARDC-12590MI	1-1/4"	10	20
ARDC-15090MI	1-1/2"	-	5
ARDC-20090MI	2"	-	5
ARDC-25090MI	2-1/2"	-	5
ARDC-30090MI	3"	-	2
ARDC-35090MI	3-1/2"	-	1
ARDC-40090MI	4"	-	1

90° Insulated Throat
Squeeze Type
BX-Flex Connectors
Malleable Iron



AMMO#	SIZE	INNER	MASTER
ARDCI-5090MI	1/2"	25	250
ARDCI-7590MI	3/4"	10	100
ARDCI-10090MI	1"	5	50
ARDCI-12590MI	1-1/4"	5	20
ARDCI-15090MI	1-1/2"	-	5
ARDCI-20090MI	2"	-	5
ARDCI-25090MI	2-1/2"	-	5
ARDCI-30090MI	3"	-	2
ARDCI-35090MI	3-1/2"	-	1
ARDCI-40090MI	4"	-	1

Duplex Connectors 90°
For BX, Flex, NM
& MC Cable
Malleable Iron



AMMO#	SIZE	INNER	MASTER
ARFDS90-38	3/8 & 1/2"	25	250

Duplex Connectors 90°
 BX, Flex, NM & MC Cable 
 Zinc Body & Stamped Steel
 Cover



AMMO#	SIZE	INNER	MASTER
ARFDS90-38Z	3/8"	25	250

90° Double Snap Lock
 BX Connectors 
 Zinc Die Cast



AMMO#	SIZE	INNER	MASTER
ARDDSL90-38	3/8"	25	250
ARDDSL90-50	1/2"	25	250

45° Top-Bite Saddle Connectors Insulated Throat Malleable Iron



AMMO#	SIZE	INNER	MASTER
ARDBTSC45-38I	3/8"	50	300
ARDBTSC45-50I	1/2"	25	150
ARDBTSC45-75I	3/4"	20	120

90° Insulated Throat Top-Bite Saddle Type Connectors Malleable Iron



AMMO#	SIZE	INNER	MASTER
ARDTB90-38I	3/8"	50	300
ARDTB90-50I	1/2"	25	150
ARDTB90-75I	3/4"	20	120
ARDTB90-100I	1"	5	60

BX-Flex Connectors Screw In Type Insulated Throat Zinc Dice Cast



AMMO#	SIZE	INNER	MASTER
ARBFCS-38IT	3/8"	50	500
ARBFCS-50IT	1/2"	50	500
ARBFCS-75IT	3/4"	25	250
ARBFCS-100IT	1"	25	250
ARBFCS-125IT	1-1/4"	10	100
ARBFCS-150IT	1-1/2"	10	40
ARBFCS-200IT	2"	10	40

Zinc Die Cast Connectors



AMMO#	SIZE	TYPE	INNER	MASTER
AR-1001	3/8"	Duplex Connector	25	250
AR-1002	3/8"	Duplex Connector One Screw	25	250
AR-1003	3/8"	Duplex Connector One Screw Clamp	25	250
AR-1004A	3/8"	Duplex Connector Saddle	50	500
AR-1005A	3/8"	90° Squeeze Connector	25	250
AR-1005B	1/2"	90° Squeeze Connector	25	250
AR-1006	3/8"	Bx Connector Set Screw	100	1000
AR-1007A	3/8"	Cable Connectors With Steel Clamps	100	1000
AR-1008A	3/8"	Flex Screw In Snap Connector	100	1000
AR-1008B	1/2"	Flex Screw In Snap Connector	50	500
AR3838AST	3/8"	MC Snap-In Cable Connectors	25	250
AR-4040AST	1/2"	Snap-2It Duplex Connectors	25	250
AR-38AST	3/8"	Connectors Insulated Throat Zinc Die Cast	50	500



AR-1001



AR-1002



AR-1003



AR-1004A



AR-1006



AR-1005A



AR-1005B



AR-1007A



AR-1008A



AR-1008B



AR-3838AST



AR-4040AST

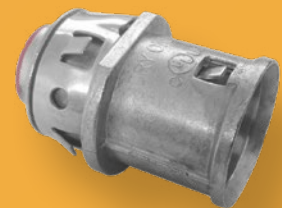

AR-38AST

BX-Flex Connectors
Screw In Type
Zinc Die Cast



AMMO#	SIZE	INNER	MASTER
ARFLEXC-50	1/2"	50	500
ARFLEXC-75	3/4"	25	250
ARFLEXC-100	1	25	250
ARFLEXC-125	1-1/4"	10	100
ARFLEXC-150	1-1/2"	10	40
ARFLEXC-200	2"	10	40



BX-Flex Connectors
Screw in Type
Zinc Die Cast



AMMO#	SIZE	INNER	MASTER
ARBFCS-38	3/8"	50	500
ARBFCS-50	1/2"	50	500
ARBFCS-75	3/4"	25	250
ARBFCS-100	1"	25	250
ARBFCS-125	1-1/4"	10	100
ARBFCS-150	1-1/2"	10	40
ARBFCS-200	2"	10	40



EMT To Flex Couplings Zinc Die Cast



AMMO#	SIZE	INNER	MASTER
AREFC-50	1/2"	25	250
AREFC-75	3/4"	25	100
AREFC-100	1"	10	100

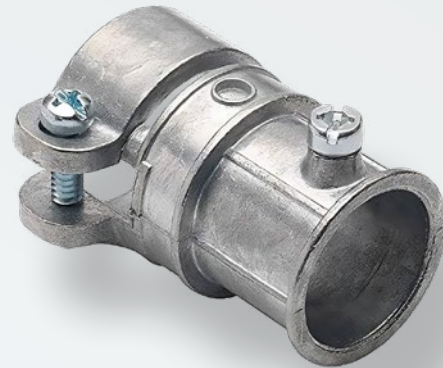

NM Connectors Clamp Type 2 Screws Zinc Die Cast



Designed to connect non-metallic sheathed cable and flexible cord to a steel outlet box

AMMO#	SIZE	INNER	MASTER
ARNMCN-50	3/8"-1/2"	100	1000
ARNMCN-75	3/4"	25	250
ARNMCN-100	1"	25	250
ARNMCN-125	1-1/4"	10	100
ARNMCN-150	1-1/2"	10	100
ARNMCN-200	2"	5	50



Connectors Take All Zinc Die Cast



Take All Connectors are designed for use with MC, AC, NM SE round cable boxes

AMMO#	SIZE	INNER	MASTER
ARTA911	1/2"	25	250
ARTA912	3/4"	20	200
ARTA913	1"	10	100
ARTA914	1-1/4"	10	100
ARTA915	1-1/2"	5	50
ARTA916	2"	-	50



Screw in Type Couplings EMT Compression to Flex Zinc Die Cast



AMMO#	SIZE	INNER	MASTER
ARSCCTF-50	1/2"	25	250
ARSCCTF-75	3/4"	10	100
ARSCCTF-100	1"	5	50



Set Screws Clamps Type EMT to Flex Zinc Die Cast



AMMO#	SIZE	INNER	MASTER
ARSCCTF-50	1/2"	25	250
ARSCCTF-75	3/4"	10	100
ARSCCTF-100	1"	5	50



Universal Snap-In Bushings

AMMO#	PKG
ARUSB	100

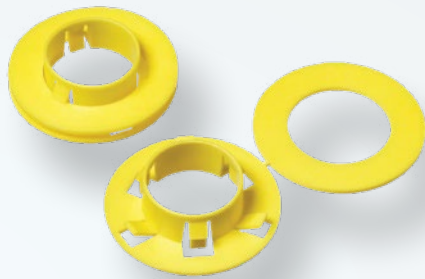

Anti Short Bushings

AMMO#	FLEX SIZE	INNER	MASTER
ARA0	5/16"	35	500
ARA1	3/8"	35	400



NM Snap-In Connectors



AMMO#	KO SIZE	WIRE SIZE	INNER	MASTER
ARNMSC-50	1/2"	14/2 & 10/3	100	1000
ARNMSC-75	3/4"	14/3 & 10/3	100	1000
ARNMSCT-50	1/2"	2-Wire Two : 14/2 or 12/2 One : 14/2 or 12/2 One : 14/2 or 10/2 One : 12/2 or 10/2	50	500
ARNMSCT-75	3/4"	One : 14/3 or 12/3 One : 10/2, 8/3 or 6/3	50	500

ARNMSC-50



ARNMSC-75
ARNMSCT-75

ARNMSCT-50

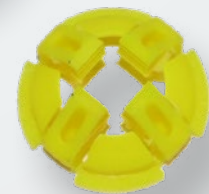

Liquid Tight Connectors

 Nylon liquid-tight connectors are electrical fittings designed for creating waterproof and dust-tight seals in electrical installations. They are typically made of durable nylon or thermoplastic materials and consist of a threaded body and a sealing gland. The sealing gland has a rubber gasket that compresses around cables, ensuring a secure seal. These connectors are commonly used in outdoor and industrial settings to protect electrical systems from moisture and contaminants. They come in various sizes, are easy to install, and often meet industry safety standards.

Non-Metallic Liquid Tight Connectors Straight



AMMO#	SIZE	INNER	MASTER
38LTNM-SC	3/8"	25	100
50LTNM-SC	1/2"	25	100
75LTNM-SC	3/4"	10	100
100LTNM-SC	1"	5	50
125LTNM-SC	1-1/4"	5	50
150LTNM-SC	1-1/2"	5	20
200LTNM-SC	2"	2	20



Non-metallic Liquid Tight Connectors 90°



AMMO#	SIZE	INNER	MASTER
38-90LTNM	3/8"	10	100
50-90LTNM	1/2"	10	100
75-90LTNM	3/4"	10	100
100-90LTNM	1"	5	50
125-90LTNM	1-1/4"	2	20
150-90LTNM	1-1/2"	2	20
200-90LTNM	2"	1	20



Non-Metallic Black Liquid Tight Connectors Straight



AMMO#	SIZE	INNER	MASTER
ARBNSLT-38	3/8"	10	100
ARBNSLT-50	1/2"	10	100
ARBNSLT-75	3/4"	10	100
ARBNSLT-100	1"	5	50
ARBNSLT-125	1-1/4"	2	20
ARBNSLT-150	1-1/2"	2	20
ARBNSLT-200	2"	1	10

Non-metallic Black Liquid Tight Connectors 90°



AMMO#	SIZE	INNER	MASTER
ARBNSLT90-38	3/8"	10	100
ARBNSLT90-50	1/2"	10	100
ARBNSLT90-75	3/4"	10	100
ARBNSLT90-100	1"	5	50
ARBNSLT90-125	1-1/4"	2	20
ARBNSLT90-150	1-1/2"	2	20
ARBNSLT90-200	2"	1	10

Liquid Tight Connectors Straight Zinc Die Cast



AMMO#	SIZE	INNER	MASTER
ARLTCN-50	1/2"	20	200
ARLTCN-75	3/4"	10	100
ARLTCN-100	1"	5	50
ARLTCN-125	1-1/4"	5	50
ARLTCN-150	1-1/2"	2	20
ARLTCN-200	2"	2	20
ARLTCN-250	2-1/2"	-	1
ARLTCN-300	3"	-	1
ARLTCN-350	3-1/2"	-	1
ARLTCN-400	4"	-	1



Liquid Tight Connectors 90° Zinc Die Cast



AMMO#	SIZE	INNER	MASTER
ARLTCN90-50	1/2"	25	250
ARLTCN90-75	3/4"	10	100
ARLTCN90-100	1"	5	50
ARLTCN90-125	1-1/4"	2	20
ARLTCN90-150	1-1/2"	2	20
ARLTCN90-200	2"	1	10
ARLTCN90-250	2-1/2"	-	1
ARLTCN90-300	3"	-	1
ARLTCN90-350	3-1/2"	-	1
ARLTCN90-400	4"	-	1



Liquid Tight Connectors Straight Insulated Zinc Die Cast



AMMO#	SIZE	INNER	MASTER
ARLTCN-38I	3/8 1/2" KO	20	200
ARLTCN-50I	1/2"	20	200
ARLTCN-75I	3/4"	10	100
ARLTCN-100I	1"	5	50
ARLTCN-125I	1-1/4"	5	50
ARLTCN-150I	1-1/2"	2	20
ARLTCN-200I	2"	2	20



Liquid Tight Connectors 90° Insulated Zinc Die Cast



AMMO#	SIZE	INNER	MASTER
ARLTCN90-50I	1/2"	10	100
ARLTCN90-75I	3/4"	10	100
ARLTCN90-100I	1"	5	50
ARLTCN90-125I	1-1/4"	2	20
ARLTCN90-150I	1-1/2"	2	20
ARLTCN90-200I	2"	1	10

Liquid Tight
Straight Connectors 
Malleable Iron

AMMO#	SIZE	INNER	MASTER
ARLTCN-38MI	3/8"	20	200
ARLTCN-50MI	1/2"	20	200
ARLTCN-75MI	3/4"	10	100
ARLTCN-100MI	1"	5	50
ARLTCN-125MI	1-1/4"	5	50
ARLTCN-150MI	1-1/2"	2	20
ARLTCN-200MI	2"	2	20
ARLTCN-250MI	2-1/2"	-	1
ARLTCN-300MI	3"	-	1
ARLTCN-350MI	3-1/2"	-	1
ARLTCN-400MI	4"	-	1

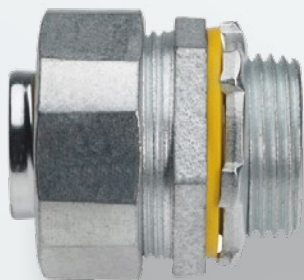

Liquid Tight 45°
Connectors 
Malleable Iron

AMMO#	SIZE	INNER	MASTER
ARLTCN45-38MI	3/8"	10	100
ARLTCN45-50MI	1/2"	10	100
ARLTCN45-75MI	3/4"	10	100
ARLTCN45-100MI	1"	5	50
ARLTCN45-125MI	1-1/4"	2	20
ARLTCN45-150MI	1-1/2"	2	20
ARLTCN45-200MI	2"	2	20
ARLTCN45-250MI	2-1/2"	-	1
ARLTCN45-300MI	3"	-	1
ARLTCN45-350MI	3-1/2"	-	1
ARLTCN45-400MI	4"	-	1



Liquid Tight 90° Connectors



Malleable Iron

AMMO#	SIZE	INNER	MASTER
ARLTCN90-38MI	3/8"	10	100
ARLTCN90-50MI	1/2"	10	100
ARLTCN90-75MI	3/4"	10	100
ARLTCN90-100MI	1"	5	50
ARLTCN90-125MI	1-1/4"	2	20
ARLTCN90-150MI	1-1/2"	2	20
ARLTCN90-200MI	2"	1	10
ARLTCN90-250MI	2-1/2"	-	1
ARLTCN90-300MI	3"	-	1
ARLTCN90-350MI	3-1/2"	-	1
ARLTCN90-400MI	4"	-	1



Liquid Tight Straight Ground Connectors



Malleable Iron

AMMO#	SIZE	INNER	MASTER
ARLTGN-38MI	3/8"	10	100
ARLTGN-50MI	1/2"	10	100
ARLTGN-75MI	3/4"	5	50
ARLTGN-100MI	1"	5	50
ARLTGN-125MI	1-1/4"	2	20
ARLTGN-150MI	1-1/2"	2	20
ARLTGN-200MI	2"	2	20
ARLTGN-250MI	2-1/2"	-	1
ARLTGN-300MI	3"	-	1
ARLTGN-350MI	3-1/2"	-	1
ARLTGN-400MI	4"	-	1



Liquid Tight 45° Ground Connectors



Malleable Iron

AMMO#	SIZE	INNER	MASTER
ARLTGN45-38MI	3/8"	5	50
ARLTGN45-50MI	1/2"	5	50
ARLTGN45-75MI	3/4"	5	50
ARLTGN45-100MI	1"	2	20
ARLTGN45-125MI	1-1/4"	2	20
ARLTGN45-150MI	1-1/2"	2	20
ARLTGN45-200MI	2"	2	20
ARLTGN45-250MI	2-1/2"	-	1
ARLTGN45-300MI	3"	-	1
ARLTGN45-350MI	3-1/2"	-	1
ARLTGN45-400MI	4"	-	1



Liquid Tight 90° Ground Connectors



Malleable Iron

AMMO#	SIZE	INNER	MASTER
ARLTGN90-38MI	3/8"	5	50
ARLTGN90-50MI	1/2"	5	50
ARLTGN90-75MI	3/4"	2	20
ARLTGN90-100MI	1"	2	20
ARLTGN90-125MI	1-1/4"	2	20
ARLTGN90-150MI	1-1/2"	2	20
ARLTGN90-200MI	2"	2	20
ARLTGN90-250MI	2-1/2"	-	1
ARLTGN90-300MI	3"	-	1
ARLTGN90-350MI	3-1/2"	-	1
ARLTGN90-400MI	4"	-	1

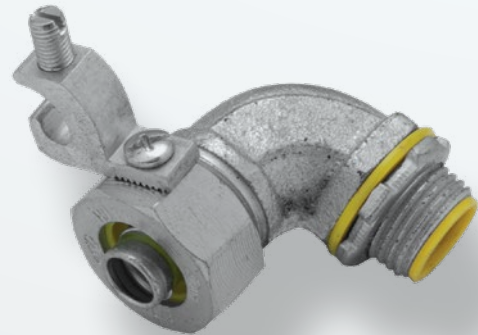

Liquid Tight Straight Insulated Connectors

Zinc Plated Steel



AMMO#	SIZE	INNER	MASTER
ARSSLT-38I	3/8"	20	200
ARSSLT-50I	1/2"	20	200
ARSSLT-75I	3/4"	10	100
ARSSLT-100I	1"	5	50
ARSSLT-125I	1-1/4"	5	50
ARSSLT-150I	1-1/2"	2	20
ARSSLT-200I	2"	2	20



Liquid Tight Rigid Combination Couplings

Zinc Plated Steel



AMMO#	SIZE	INNER	MASTER
ARCCPLT-38	3/8"	20	200
ARCCPLT-50	1/2"	20	200
ARCCPLT-75	3/4"	10	100
ARCCPLT-100	1"	5	50
ARCCPLT-125	1-1/4"	5	50
ARCCPLT-150	1-1/2"	-	12
ARCCPLT-200	2"	-	5



Rigid Compression Connectors



Steel

Joins threadless rigid or IMC conduit to steel box or enclosure

AMMO#	SIZE	INNER	MASTER
ARRC01	1/2"	20	200
ARRC02	3/4"	10	100
ARRC03	1"	5	50
ARRC04	1-1/4"	5	50
ARRC05	1-1/2"	-	12
ARRC06	2"	-	12
ARRC07	2-1/2"	-	5
ARRC08	3"	-	3
ARRC09	3-1/2"	-	2
ARRC10	4"	-	2



Rigid Compression Couplings



Steel

AMMO#	SIZE	INNER	MASTER
ARRP01	1/2"	10	100
ARRP02	3/4"	10	100
ARRP03	1"	5	50
ARRP04	1-1/4"	5	50
ARRP05	1-1/2"	-	12
ARRP06	2"	-	12
ARRP07	2-1/2"	-	5
ARRP08	3"	-	3
ARRP09	3-1/2"	-	2
ARRP10	4"	-	2



Rigid Raintight Connectors Zinc Plated Steel



AMMO#	SIZE	INNER	MASTER
ARRTC01	1/2"	10	100
ARRTC02	3/4"	10	100
ARRTC03	1"	5	50
ARRTC04	1-1/4"	5	50
ARRTC05	1-1/2"	1	12
ARRTC06	2"	1	5



Rigid Raintight Compression Couplings Zinc Plated Steel



AMMO#	SIZE	INNER	MASTER
ARRTP01	1/2"	10	100
ARRTP02	3/4"	10	100
ARRTP03	1"	5	50
ARRTP04	1-1/4"	5	50
ARRTP05	1-1/2"	1	12
ARRTP06	2"	1	5



Rigid Compression Connectors



Malleable Iron

AMMO#	SIZE	INNER	MASTER
ARRCT-50MI	1/2"	20	200
ARRCT-75MI	3/4"	10	100
ARRCT-100MI	1"	5	50
ARRCT-125MI	1-1/4"	5	50
ARRCT-150MI	1-1/2"	-	12
ARRCT-200MI	2"	-	12
ARRCT-250MI	2-1/2"	-	5
ARRCT-300MI	3"	-	3
ARRCT-350MI	3-1/2"	-	2
ARRCT-400MI	4"	-	2



Rigid Set Screw Couplings



Malleable Iron

AMMO#	SIZE	PKG
ARSTRC-50MI	1"	25
ARSTRC-75MI	1-1/4"	25
ARSTRC-100MI	1"	25
ARSTRC-125MI	1-1/4"	50
ARSTRC-150MI	1-1/2"	40
ARSTRC-200MI	2"	20
ARSTRC-250MI	2-1/2"	12
ARSTRC-300MI	3"	12
ARSTRC-400MI	4"	6



Rigid Three Piece Couplings

Steel



AMMO#	SIZE	INNER	MASTER
ARTPC-50S	1/2"	20	200
ARTPC-75S	3/4"	10	100
ARTPC-100S	1"	5	50
ARTPC-125S	1-1/4"	5	50
ARTPC-150S	1-1/2"	3	30
ARTPC-200S	2"	-	20



Rigid Three Piece Couplings

Malleable Iron



AMMO#	SIZE	INNER	MASTER
ARTPC-50	1/2"	20	200
ARTPC-75	3/4"	10	100
ARTPC-100	1"	5	50
ARTPC-125	1-1/4"	5	50
ARTPC-150	1-1/2"	3	30
ARTPC-200	2"	-	20
ARTPC-250	2-1/2"	-	10
ARTPC-300	3"	-	5
ARTPC-350	3-1/2"	-	5
ARTPC-400	4"	-	2
ARTPC-500	5"	-	1



Rigid Three Piece Couplings HDG

Malleable Iron



AMMO#	SIZE	INNER	MASTER
ARTPC-50HDG	1/2"	20	200
ARTPC-75HDG	3/4"	10	100
ARTPC-100HDG	1"	5	50
ARTPC-125HDG	1-1/4"	5	50
ARTPC-150HDG	1-1/2"	3	30
ARTPC-200HDG	2"	2	20
ARTPC-250HDG	2-1/2"	-	10
ARTPC-300HDG	3"	-	5
ARTPC-350HDG	3-1/2"	-	5
ARTPC-400HDG	4"	-	2



Threaded Grounding Bushings Insulated Malleable Iron



AMMO#	SIZE	INNER	MASTER
ARGB-50I	1/2"	50	500
ARGB-75I	3/4"	50	500
ARGB-100I	1"	25	250
ARGB-125I	1-1/4"	20	200
ARGB-150I	1-1/2"	10	100
ARGB-200I	2"	10	50
ARGB-250I	2-1/2"	-	50
ARGB-300I	3"	-	25
ARGB-350I	3-1/2"	-	10
ARGB-400I	4"	-	10



Threaded Grounding Bushings Insulated Hot Dip Galvanized Malleable Iron



AMMO#	SIZE	INNER	MASTER
ARGBU-50MHDG	1/2"	50	500
ARGBU-75MHDG	3/4"	50	500
ARGBU-100MHDG	1"	25	250
ARGBU-125MHDG	1-1/4"	20	200
ARGBU-150MHDG	1-1/2"	10	100
ARGBU-200MHDG	2"	10	100
ARGBU-250MHDG	2-1/2"	5	50
ARGBU-300MHDG	3"	-	25
ARGBU-350MHDG	3-1/2"	-	10
ARGBU-400MHDG	4"	-	10



Threaded Grounding Bushings Insulated



Zinc Metallic

AMMO#	SIZE	INNER	MASTER
ARGBU-50I	1/2"	50	500
ARGBU-75I	3/4"	50	500
ARGBU-100I	1"	25	250
ARGBU-125I	1-1/4"	20	200
ARGBU-150I	1-1/2"	10	100
ARGBU-200I	2"	10	100
ARGBU-250I	2-1/2"	-	50
ARGBU-300I	3"	-	50
ARGBU-350I	3-1/2"	-	10
ARGBU-400I	4"	-	10

Threaded Grounding Bushings Insulated



Zinc Metallic

AMMO#	SIZE	INNER	MASTER
ARGBU-125IA	1-1/4"	20	200
ARGBU-150IA	1-1/2"	10	100
ARGBU-200IA	2"	10	100
ARGBU-250IA	2-1/2"	-	50
ARGBU-300IA	3"	-	50
ARGBU-350IA	3-1/2"	-	10
ARGBU-400IA	4"	-	10



Reducing Bushings

Steel



Conduit Bushings

Insulated
Malleable Iron



AMMO#	SIZE	PKG
ARRB7550	3/4"x1/2"	100
ARRB10050	1"x1/2"	50
ARRB10075	1"x3/4"	50
ARRB12550	1-1/4"x1/2"	25
ARRB12575	1-1/4"x3/4"	25
ARRB125100	1-1/4"x1"	25
ARRB15075	1-1/2"x3/4"	25
ARRB150100	1-1/2"x1"	25
ARRB150125	1-1/2"x1-1/4"	25
ARRB20075	2"x3/4"	10
ARRB200125	2"x1-1/4"	10
ARRB200150	2"x1-1/2"	10
ARRB250150	2-1/2"x1-1/2"	10
ARRB300150	3"x1-1/2"	10
ARRB300200	3"x2"	10
ARRB300250	3"x2-1/2"	10
ARRB400300	4"x3"	10
ARRB400350	4" x 3-1/2"	10

AMMO#	SIZE	INNER	MASTER
ARBU-50MI	1/2"	100	1000
ARBU-75MI	3/4"	100	1000
ARBU-100MI	1"	50	500
ARBU-125MI	1-1/4"	25	250
ARBU-150MI	1-1/2"	25	250
ARBU-200MI	2"	10	100
ARBU-250MI	2-1/2"	10	100
ARBU-300MI	3"	10	100
ARBU-350MI	3-1/2"	-	10
ARBU-400MI	4"	-	10
ARBU-500MI	5"	-	10
ARBU-600MI	6"	-	10

EMT Insulating Bushings

Polyethelene



AMMO#	SIZE	INNER	MASTER
ARBB-50I	1/2"	100	1000
ARBB-75I	3/4"	100	1000
ARBB-100I	1"	50	500
ARBB-125I	1-1/4"	25	250
ARBB-150I	1-1/2"	25	250
ARBB-200I	2"	20	200
ARBB-250I	2-1/2"	-	25
ARBB-300I	3"	-	25
ARBB-350I	3-1/2"	-	25
ARBB-400I	4"	-	25

Plastic Threaded Bushings



AMMO#	SIZE	INNER	MASTER
ARBB01	1/2"	100	1000
ARBB02	3/4"	100	1000
ARBB03	1"	50	500
ARBB04	1-1/4"	25	250
ARBB05	1-1/2"	25	250
ARBB06	2"	20	200
ARBB07	2-1/2"	-	50
ARBB08	3"	-	25
ARBB09	3-1/2"	-	25
ARBB10	4"	-	10
ARBB11	5"	-	10
ARBB12	6"	-	10

Conduit Supports

Rmc U-Bolts With
Hex Nuts
Hot Dip Galvanized



AMMO#	SIZE	INNER	MASTER
ARMCHN-50HDG	1/2"	50	250
ARMCHN-75HDG	3/4"	25	250
ARMCHN-100HDG	1"	20	250
ARMCHN-125HDG	1-1/4"	20	200
ARMCHN-150HDG	1-1/2"	10	200
ARMCHN-200HDG	2"	10	100
ARMCHN-250HDG	2-1/2"	10	20
ARMCHN-300HDG	3"	10	20
ARMCHN-350HDG	3-1/2"	-	20
ARMCHN-400HDG	4	-	20

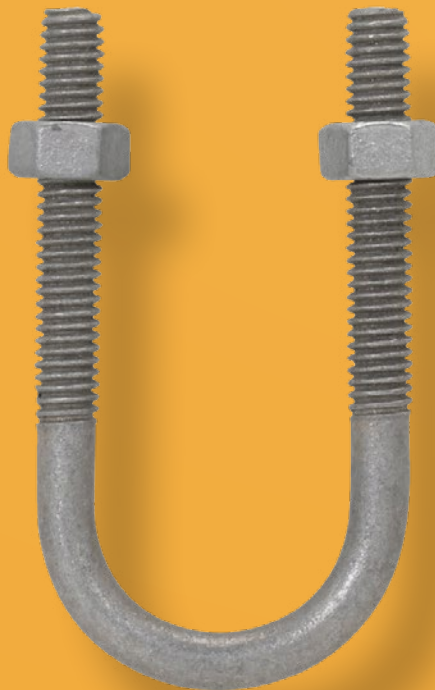

Right Angle Conduit Supports



Hot Dip Galvanized

AMMO#	SIZE	PKG
ARRACS-50HDG	1/2"	50
ARRACS-75HDG	3/4"	50
ARRACS-100HDG	1"	50
ARRACS-125HDG	1-1/4"	50
ARRACS-150HDG	1-1/2"	50
ARRACS-200HDG	2"	50
ARRACS-250HDG	2-1/2"	25
ARRACS-300HDG	3"	25
ARRACS-350HDG	3-1/2"	25
ARRACS-400HDG	4	25



Right Angle Conduit Supports



Malleable Iron

AMMO#	SIZE	PKG
ARRACS-38MI	3/8"	50
ARRACS-50MI	1/2"	50
ARRACS-75MI	3/4"	50
ARRACS-100MI	1"	50
ARRACS-125MI	1-1/4"	50
ARRACS-150MI	1-1/2"	50
ARRACS-200MI	2"	50
ARRACS-250MI	2-1/2"	25
ARRACS-300MI	3"	25
ARRACS-350MI	3-1/2"	25
ARRACS-400MI	4	25



Parallel
Conduit Supports
Malleable Iron



AMMO#	SIZE	PKG
ARPCS-50MI	1/2"	50
ARPCS-75MI	3/4"	50
ARPCS-100MI	1"	50
ARPCS-125MI	1-1/4"	25
ARPCS-150MI	1-1/2"	25
ARPCS-200MI	2"	25
ARPCS-250MI	2-1/2"	10
ARPCS-300MI	3"	10
ARPCS-350MI	3-1/2"	10
ARPCS-400MI	4"	10



Parallel
Conduit Supports
Hot Dip Galvanized



AMMO#	SIZE	PKG
ARPCS-50HDG	1/2"	50
ARPCS-75HDG	3/4"	50
ARPCS-100HDG	1"	50
ARPCS-125HDG	1-1/4"	25
ARPCS-150HDG	1-1/2"	25
ARPCS-200HDG	2"	25
ARPCS-250HDG	2-1/2"	10
ARPCS-300HDG	3"	10
ARPCS-350HDG	3-1/2"	10
ARPCS-400HDG	4"	10

Edge Type Conduit Supports Hot Dip Galvanized



AMMO#	SIZE	PKG
ARECSM-50HDG	1/2"	50
ARECSM-75HDG	3/4"	50
ARECSM-100HDG	1"	50
ARECSM-125HDG	1-1/4"	25
ARECSM-150HDG	1-1/2"	25
ARECSM-200HDG	2"	25
ARECSM-250HDG	2-1/2"	10
ARECSM-300HDG	3"	10



Edge Type Conduit Supports Malleable Iron



AMMO#	SIZE	PKG
ARECSM-50MI	1/2"	50
ARECSM-75MI	3/4"	50
ARECSM-100MI	1"	50
ARECSM-125MI	1-1/4"	25
ARECSM-150MI	1-1/2"	25
ARECSM-200MI	2"	25
ARECSM-250MI	2-1/2"	10
ARECSM-300MI	3"	10

Rigid Watertight Hubs Malleable Iron



AMMO#	SIZE	INNER	MASTER
ARWTH-50	1/2"	25	250
ARWTH-75	3/4"	10	100
ARWTH-100	1"	10	100
ARWTH-125	1-1/4"	2	20
ARWTH-150	1-1/2"	2	20
ARWTH-200	2"	2	20
ARWTH-250	2-1/2"	2	20
ARWTH-300	3"	-	1
ARWTH-350	3.5"	-	1
ARWTH-400	4"	-	1



Rigid Watertight Hubs With Bonding Screw Zinc Die Cast



AMMO#	SIZE	INNER	MASTER
ARGWTH-50	1/2"	25	250
ARGWTH-75	3/4"	10	100
ARGWTH-100	1"	10	100
ARGWTH-125	1 1/4"	2	20
ARGWTH-150	1 1/2"	2	20
ARGWTH-200	2"	2	20
ARGWTH-250	2 1/2"	2	2
ARGWTH-300	3"	-	2
ARGWTH-350	3 1/2"	-	1
ARGWTH-400	4"	-	1



Steel Locknuts Zinc Plated Steel



Steel locknuts are used to secure threaded conduits or connectors to electrical junction boxes

AMMO#	SIZE	INNER	MASTER
ARLNS-50	1/2"	200	2000
ARLNS-75	3/4"	100	1000
ARLNS-100	1"	100	1000
ARLNS-125	1-1/4"	50	500
ARLNS-150	1-1/2"	50	500
ARLNS-200	2"	25	250
ARLNS-250	2-1/2"	-	50
ARLNS-300	3"	-	50
ARLNS-350	3-1/2"	-	25
ARLNS-400	4"	-	25

Sealing Locknuts Steel Heavy Stock Steel



Used to connect threaded conduit or connectors to a threadless opening in a box enclosure, or fitting

AMMO#	SIZE	INNER	MASTER
ARSL-50	1/2"	50	500
ARSL-75	3/4"	50	500
ARSL-100	1"	25	250
ARSL-125	1-1/4"	10	100
ARSL-150	1-1/2"	10	100
ARSL-200	2"	10	100
ARSL-250	2-1/2"	-	25
ARSL-300	3"	-	25
ARSL-350	3-1/2"	-	25
ARSL-400	4"	-	25

Grounding Locknuts Zinc Plated Steel



Used to secure threaded conduits or connectors to electrical junction boxes or enclosures in wet locations

AMMO#	SIZE	INNER	MASTER
ARGL-50	1/2"	100	1000
ARGL-75	3/4"	100	1000
ARGL-100	1"	50	500
ARGL-125	1-1/4"	50	500
ARGL-150	1-1/2"	25	250
ARGL-200	2"	20	200
ARGL-250	2-1/2"	-	50
ARGL-300	3"	-	50
ARGL-350	3-1/2"	-	25
ARGL-400	4"	-	25

Rigid Chase Nipples



Zinc Die Cast

AMMO#	SIZE	INNER	MASTER
ARCN-50	1/2"	100	1000
ARCN-75	3/4"	50	500
ARCN-100	1"	25	250
ARCN-125	1-1/4"	25	250
ARCN-150	1-1/2"	25	100
ARCN-200	2"	10	40
ARCN-250	2-1/2"	10	40
ARCN-300	3"	10	40
ARCN-350	3-1/2"	10	40
ARCN-400	4"	5	20



A nipple is a short pipe fitting, which creates a path for wires between two electrical boxes.



Rigid Chase Nipples



Malleable Iron

AMMO#	SIZE	INNER	MASTER
ARCNM-50	1/2"	100	1000
ARCNM-75	3/4"	50	500
ARCNM-100	1"	25	250
ARCNM-125	1-1/4"	25	250
ARCNM-150	1-1/2"	10	100
ARCNM-200	2"	10	40
ARCNM-250	2-1/2"	10	40
ARCNM-300	3"	10	40
ARCNM-350	3-1/2"	10	40
ARCNM-400	4"	5	20
ARCNM-500	4"	5	20
ARCNM-600	6"	1	1



A nipple is a short pipe fitting, which creates a path for wires between two electrical boxes.



Rigid Chase Nipples Insulated Malleable Iron



AMMO#	SIZE	INNER	MASTER
ARCNM-50I	1/2"	100	1000
ARCNM-75I	3/4"	50	500
ARCNM-100I	1"	25	250
ARCNM-125I	1-1/4"	25	250
ARCNM-150I	1-1/2"	10	100
ARCNM-200I	2"	10	40
ARCNM-250I	2-1/2"	10	40
ARCNM-300I	3"	10	40
ARCNM-350I	3-1/2"	10	40
ARCNM-400I	4"	5	20
ARCNM-500I	4"	5	1
ARCNM-600I	6"	1	1



Rigid Offset Nipples Zinc Die Cast



AMMO#	SIZE	INNER	MASTER
AROCNZ-50	1/2"	10	100
AROCNZ-75	3/4"	10	100
AROCNZ-100	1"	10	100
AROCNZ-125	1-1/4"	5	50
AROCNZ-150	1-1/2"	5	50
AROCNZ-200	2"	2	20
*AROCNZ-250MI	2-1/2"	-	2
*AROCNZ-300MI	3"	-	2
*AROCNZ-350MI	3-1/2"	-	1
*AROCNZ-400MI	4"	-	1



For indoor or outdoor use and used as an offset connector between two enclosure



*Malleable Iron

EMT One Hole Straps **Steel**



EMT straps secure EMT conduit to wood, masonry or other surfaces.

AMMO#	SIZE	INNER	MASTER
AROS-50	1/2"	100	1000
AROS-75	3/4"	100	1000
AROS-100	1"	50	500
AROS-125	1-1/4"	25	250
AROS-150	1-1/2"	10	100
AROS-200	2"	10	100
AROS-250	2-1/2"	-	50
AROS-300	3"	-	25
AROS-350	3-1/2"	-	25
AROS-400	4"	-	25
AROS-500	5"	-	10
AROS-600	6"	-	10

EMT Two Hole Straps **Steel**



AMMO#	SIZE	INNER	MASTER
ARTHS-50	1/2"	50	500
ARTHS-75	3/4"	50	500
ARTHS-100	1"	50	500
ARTHS-125	1-1/4"	20	200
ARTHS-150	1-1/2"	20	200
ARTHS-200	2"	-	50
ARTHS-250	2-1/2"	-	25
ARTHS-300	3"	-	25
ARTHS-350	3-1/2"	-	25
ARTHS-400	4"	-	25
ARTHS-500	5"	-	10
ARTHS-600	6"	-	10

Strap One Hole-BX, Flex & MC **Steel**



AMMO#	SIZE	INNER	MASTER
AR510BX	1/4/2-10/3	100	1000

Rigid One Hole Straps **Steel**



AMMO#	SIZE	INNER	MASTER
ARROHS-50	1/2"	50	500
ARROHS-75	3/4"	50	500
ARROHS-100	1"	25	250
ARROHS-125	1-1/4"	20	200
ARROHS-150	1-1/2"	20	200
ARROHS-200	2"	10	100
ARROHS-250	2-1/2"	-	50
ARROHS-300	3"	-	25
ARROHS-350	3-1/2"	-	25
ARROHS-400	4"	-	25
ARROHS-500	5"	-	10
ARROHS-600	6"	-	10



Rigid Two Hole Straps **Steel**



AMMO#	SIZE	INNER	MASTER
ARRTHS-50	1/2"	50	500
ARRTHS-75	3/4"	50	500
ARRTHS-100	1"	25	250
ARRTHS-125	1-1/4"	20	200
ARRTHS-150	1-1/2"	10	100
ARRTHS-200	2"	-	50
ARRTHS-250	2-1/2"	-	25
ARRTHS-300	3"	-	25
ARRTHS-350	3-1/2"	-	25
ARRTHS-400	4"	-	25
ARRTHS-500	5"	-	10
ARRTHS-600	6"	-	10



Rigid One Hole Straps **Malleable Iron**



AMMO#	THREAD HOLE	INNER	MASTER
AROHSM-38	3/8"	100	1000
AROHSM-50	1/2"	100	1000
AROHSM-75	3/4"	50	500
AROHSM-100	1"	25	250
AROHSM-125	1-1/4"	20	200
AROHSM-150	1-1/2"	10	100
AROHSM-200	2"	-	25
AROHSM-250	2-1/2"	-	25
AROHSM-300	3"	-	25
AROHSM-350	3-1/2"	-	10
AROHSM-400	4"	-	10

Rigid Clamp Back Spacers

Malleable Iron



AMMO#	THREAD HOLE	INNER	MASTER
ARCBM-50	1/2"	25	250
ARCBM-75	3/4"	25	250
ARCBM-100	1"	25	250
ARCBM-125	1-1/4"	10	100
ARCBM-150	1-1/2"	10	100
ARCBM-200	2"	5	50
ARCBM-250	2-1/2"	-	25
ARCBM-300	3"	-	10
ARCBM-350	3-1/2"	-	10
ARCBM-400	4"	-	10

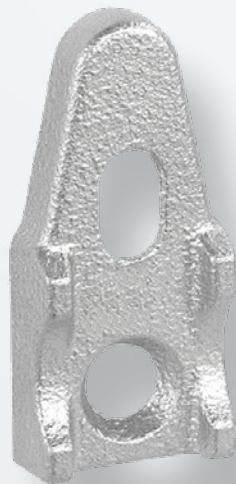

Metal Cable Staples

Steel



AMMO#	SIZE	INNER	MASTER
ARSTPE	1/2"x1"	100	5000

Metal Cable Staples Insulated

Steel



AMMO#	SIZE	INNER	MASTER
ARSTPEI	1/2"	100	5000
ARSTPEI-BKT	1/2"	-	2500

Black Insulated Connectors



Insulated connectors are essential components for electrical systems, providing both secure connections and electrical insulation. These connectors are designed for easy and safe installations, ensuring protection against short circuits and electrical hazards. With a range of sizes and types available, they are compatible with various wire gauges and applications. Trust in insulated connectors for dependable, color-coded convenience and peace of mind in all your electrical projects."

Black Insulated Connectors Dual



Wire Range #2-#14

AMMO#	WIRE RANGE	PORTS	PKG
ARCD2-1	#2-#14	Inline Splice	12
ARCD2-2	#2-#14	2	12
ARCD2-3	#2-#14	3	6
ARCD2-4	#2-#14	4	6
ARCD2-5	#2-#14	5	4
ARCD2-6	#2-#14	6	4
ARCD2-7	#2-#14	7	3
ARCD2-8	#2-#14	8	3
ARCD2-9	#2-#14	9	3
ARCD2-10	#2-#14	10	3
ARCD2-11	#2-#14	11	3
ARCD2-12	#2-#14	12	4



Black Insulated Connectors Dual



Wire Range #1/0-#14

AMMO#	WIRE RANGE	PORTS	PKG
ARCD1/0-1	#1/0-#14	Inline Splice	12
ARCD1/0-2	#1/0-#14	2	6
ARCD1/0-3	#1/0-#14	3	8
ARCD1/0-4	#1/0-#14	4	6
ARCD1/0-5	#1/0-#14	5	4
ARCD1/0-6	#1/0-#14	6	4
ARCD1/0-7	#1/0-#14	7	3
ARCD1/0-8	#1/0-#14	8	3
ARCD1/0-9	#1/0-#14	9	3
ARCD1/0-10	#1/0-#14	10	3
ARCD1/0-11	#1/0-#14	11	3
ARCD1/0-12	#1/0-#14	12	4



Black Insulated Connectors Dual



Wire Range #2/0-#6

AMMO#	WIRE RANGE	PORTS	PKG
ARCD2/0-1	#2/0-#6	Inline Splice	12
ARCD2/0-2	#2/0-#6	2	10
ARCD2/0-3	#2/0-#6	3	8
ARCD2/0-4	#2/0-#6	4	6
ARCD2/0-5	#2/0-#6	5	4
ARCD2/0-6	#2/0-#6	6	4
ARCD2/0-7	#2/0-#6	7	3
ARCD2/0-8	#2/0-#6	8	3
ARCD2/0-9	#2/0-#6	9	3
ARCD2/0-10	#2/0-#6	10	3
ARCD2/0-11	#2/0-#6	11	3
ARCD2/0-12	#2/0-#6	12	4

Black Insulated Connectors Dual



Wire Range #3/0-#6

AMMO#	WIRE RANGE	PORTS	PKG
ARCD3/0-1	#3/0-#6	Inline Splice	8
ARCD3/0-2	#3/0-#6	2	8
ARCD3/0-3	#3/0-#6	3	6
ARCD3/0-4	#3/0-#6	4	6
ARCD3/0-5	#3/0-#6	5	4
ARCD3/0-6	#3/0-#6	6	3
ARCD3/0-7	#3/0-#6	7	3
ARCD3/0-8	#3/0-#6	8	3
ARCD3/0-9	#3/0-#6	9	3
ARCD3/0-10	#3/0-#6	10	3
ARCD3/0-11	#3/0-#6	11	3
ARCD3/0-12	#3/0-#6	12	3





Black Insulated Connectors Dual

Wire Range #250-#6



AMMO#	WIRE RANGE	PORTS	PKG
ARCD250-1	250#-#6	Inline Splice	4
ARCD250-2	250#-#6	2	6
ARCD250-3	250#-#6	3	6
ARCD250-4	250#-#6	4	4
ARCD250-5	250#-#6	5	4
ARCD250-6	250#-#6	6	4
ARCD250-7	250#-#6	7	3
ARCD250-8	250#-#6	8	3
ARCD250-9	250#-#6	9	3
ARCD250-10	250#-#6	10	3
ARCD250-11	250#-#6	11	3
ARCD250-12	250#-#6	12	3



Black Insulated Connectors Dual

Wire Range #350-#6



AMMO#	WIRE RANGE	PORTS	PKG
ARCD350-1	350#-#6	Inline Splice	4
ARCD350-2	350#-#6	2	4
ARCD350-3	350#-#6	3	6
ARCD350-4	350#-#6	4	4
ARCD350-5	350#-#6	5	4
ARCD350-6	350#-#6	6	3
ARCD350-7	350#-#6	7	3
ARCD350-8	350#-#6	8	3
ARCD350-9	350#-#6	9	3
ARCD350-10	350#-#6	10	3
ARCD350-11	350#-#6	11	3
ARCD350-12	350#-#6	12	3



Black Insulated Connectors Dual

Wire Range #750-#1/0



AMMO#	WIRE RANGE	PORTS	PKG
ARCD750-1	#750-#1/0	Inline Splice	2
ARCD750-2	#750-#1/0	2	2
ARCD750-3	#750-#1/0	3	4
ARCD750-4	#750-#1/0	4	4
ARCD750-5	#750-#1/0	5	4
ARCD750-6	#750-#1/0	6	4
ARCD750-7	#750-#1/0	7	2
ARCD750-8	#750-#1/0	8	2
ARCD750-9	#750-#1/0	9	2
ARCD750-10	#750-#1/0	10	2
ARCD750-11	#750-#1/0	11	2
ARCD750-12	#750-#1/0	12	2



Black Insulated Connectors Dual

Wire Range #500-#4



AMMO#	WIRE RANGE	PORTS	PKG
ARCD500-1	#500-#4	Inline Splice	2
ARCD500-2	#500-#4	2	2
ARCD500-3	#500-#4	3	4
ARCD500-4	#500-#4	4	4
ARCD500-5	#500-#4	5	4
ARCD500-6	#500-#4	6	2
ARCD500-7	#500-#4	7	2
ARCD500-8	#500-#4	8	2
ARCD500-9	#500-#4	9	2
ARCD500-10	#500-#4	10	2
ARCD500-11	#500-#4	11	2
ARCD500-12	#500-#4	12	2

Black Insulated Connectors Dual

Wire Range #600-#4



AMMO#	WIRE RANGE	PORTS	PKG
ARCD600-1	#600-#4	Inline Splice	2
ARCD600-2	#600-#4	2	4
ARCD600-3	#600-#4	3	4
ARCD600-4	#600-#4	4	4
ARCD600-5	#600-#4	5	4
ARCD600-6	#600-#4	6	2
ARCD600-7	#600-#4	7	2
ARCD600-8	#600-#4	8	2
ARCD600-9	#600-#4	9	2
ARCD600-10	#600-#4	10	2
ARCD600-11	#600-#4	11	2
ARCD600-12	#600-#4	12	2

Electrical Tape



Electrical tape is a type of pressure-sensitive tape used to insulate electrical wires and other materials that conduct electricity. It can be made of many plastics, but vinyl is most popular, as it stretches well and gives an effective and long lasting insulation.



ET-001
7 Mil X 3/4 X 60 Ft
Black PVC Tape
200



ET-002
7 Mil X 3/4 X 60 Ft
Red PVC Tape
200



ET-003
7 Mil X 3/4 X 60 Ft
White PVC Tape
200



ET-004
7 Mil X 3/4 X 60 Ft
Blue PVC Tape
200



ET-005
7 Mil X 3/4 X 60 Ft
Green PVC Tape
200



ET-006
7 Mil X 3/4 X 60 Ft
Brown PVC Tape
200



ET-007
7 Mil X 3/4 X 60 Ft
Orange PVC Tape
200



ET-008
7 Mil X 3/4 X 60 Ft
Yellow PVC Tape
200



ET-009
7 Mil X 3/4 X 60 Ft
Gray PVC Tape
200



ET-010
7 Mil X 3/4 X 60 Ft
Purple PVC Tape
200

AMMO#

ET-011

SIZE

7 Mil X 2 X 60 Ft

COLOR

Black PVC Tape

PKG

200



2" wide



Wire Connectors

UL LISTED										
	AMMO#	AWCBF-100	AWCBF-500	AWCGF-100	AWCGF-500	AWCOF-100	AWCOF-500	AWCRF-100	AWCRF-500	AWCYF-100
MIN	2#22	2#22	2#22	2#22	2#22	2#22	3#18	3#18	2#14	2#14
MAX	2#16	2#16	2#16	2#16	2#16	2#16	4#14&1#18	4#14&1#18	4#12	4#12
COLOR	Blue	Blue	Gray	Gray	Orange	Orange	Red	Red	Yellow	Yellow
PKG	100 Bag	500 Bag	100 Bag	500 Bag	100 Bag	500 Bag	100 Bag	500 Bag	100 Bag	500 Bag

Wire Connectors Winged

UL LISTED										
	AMMO#	AWCB-100	AWCB-500	AWCG-100	AWCG-500	AWCR-100	AWCR-500	AWCT-100	AWCT-500	AWCY-100
MIN	2#22	2#22	2#22	2#22	2#22	2#22	3#18	3#18	2#14	2#14
MAX	2#16	2#16	2#16	2#16	2#16	2#16	4#14&1#18	4#14&1#18	4#12	4#12
COLOR	Blue	Blue	Grey	Grey	Red	Red	Tan	Tan	Yellow	Yellow
PKG	100 Bag	500 Bag	100 Bag	500 Bag	100 Bag	500 Bag	100 Bag	500 Bag	100 Bag	100 Bag

Black Cable Ties

4"

AMMO#	ARBT04-100	ARBT04-1000	ARBT05-100	ARBT05-1000	ARBT07-100	ARBT07-1000
Qty	100	1000	100	1000	100	1000
Color	Black	Black	Black	Black	Black	Black
Size	100mm	100mm	140mm	140mm	180mm	180mm
PKG	100	1,000	100	1,000	100	1,000

5"

7"

8"

AMMO#	ARBT08-100	ARBT08-1000	ARBT11-100	ARBT11-1000	ARBT14-100	ARBT14-1000
Qty	100	1000	100	1000	100	1000
Color	Black	Black	Black	Black	Black	Black
Size	200mm	200mm	280mm	280mm	350mm	350mm
PKG	100	1,000	100	1,000	100	1,000

11"

14"

18"

AMMO#	ARBT18-100	ARBT18-1000
Qty	100	1000
Color	Black	Black
Size	450mm	450mm
PKG	100	1,000



*All measurements are approximate and are intended for commercial guidance.

White Cable Ties

	4"		5"		7"	
AMMO#	ARWT04-100	ARWT04-1000	ARWT05-100	ARWT05-1000	ARWT07-100	ARWT07-1000
Qty	100	1000	100	1000	100	1000
Color	White	White	White	White	White	White
Size	100 mm	100 mm	140 mm	140 mm	180mm	180mm
PKG	100	1,000	100	1,000	100	1,000

	8"		11"		14"	
AMMO#	ARWT08-100	ARWT08-1000	ARWT11-100	ARWT11-1000	ARWT14-100	ARWT14-1000
Qty	100	1000	100	1000	100	1000
Color	White	White	White	White	White	White
Size	200 mm	200 mm	280 mm	280 mm	350 mm	350 mm
PKG	100	1,000	100	1,000	100	1,000

	18"	
AMMO#	ARWT18-100	ARWT18-1000
Qty	100	1000
Color	White	White
Size	450 mm	450 mm
PKG	100	1,000



Black Cable Ties with Hole

4"

AMMO#	ARHBT04-100	ARHBT04-1000	ARHBT06-100	ARHBT06-1000	ARHBT07-100	ARHBT07-1000
Qty	100	1000	100	1000	100	1000
Color	Black	Black	Black	Black	Black	Black
Size	110mm	110mm	150mm	150mm	160mm	160mm
Inner	100	1,000	100	1,000	100	1,000
Master	60,000	40,000	60,000	40,000	20,000	20,000

6"

7"

8"

11"

14"

AMMO#	ARHBT08-100	ARHBT08-1000	ARHBT11-100	ARHBT11-1000	ARHBT14-100	ARHBT14-1000
Qty	100	1000	100	1000	100	1000
Color	Black	Black	Black	Black	Black	Black
Size	200mm	200mm	300mm	300mm	370mm	370mm
Inner	100	1,000	100	1,000	100	1,000
Master	20,000	20,000	10,000	10,000	10,000	10,000

18"

AMMO#	ARHBT18-100	ARHBT18-1000
Qty	100	1000
Color	Black	Black
Size	400mm	400mm
Inner	100	1,000
Master	4,000	4,000



**All measurements are approximate and are intended for commercial guidance.*

White Cable Ties with Hole

4"

AMMO#	4"		5"		7"	
	ARHWT04-100	ARHWT04-1000	ARHWT05-100	ARHWT05-1000	ARHWT07-100	ARHWT07-1000
Qty	100	1000	100	1000	100	1000
Color	White	White	White	White	White	White
Size	100 mm	100 mm	130 mm	130 mm	180 mm	180 mm
Inner	100	1,000	100	1,000	100	1,000
Master	60,000	40,000	60,000	40,000	20,000	20,000

5"

7"

8"

AMMO#	8"		11"		14"	
	ARHWT08-100	ARHWT08-1000	ARHWT11-100	ARHWT11-1000	ARHWT14-100	ARHWT14-1000
Qty	100	1000	100	1000	100	1000
Color	White	White	White	White	White	White
Size	200 mm	200 mm	280 mm	280 mm	360 mm	360 mm
Inner	100	1,000	100	1,000	100	1,000
Master	20,000	20,000	10,000	10,000	10,000	10,000

11"

14"

18"

AMMO#	18"	
	ARHWT18-100	ARHWT18-1000
Qty	100	1000
Color	White	White
Size	450 mm	450 mm
Inner	100	1,000
Master	4,000	4,000





Adhesive Base Nylon Cable Tie Mounting Platforms

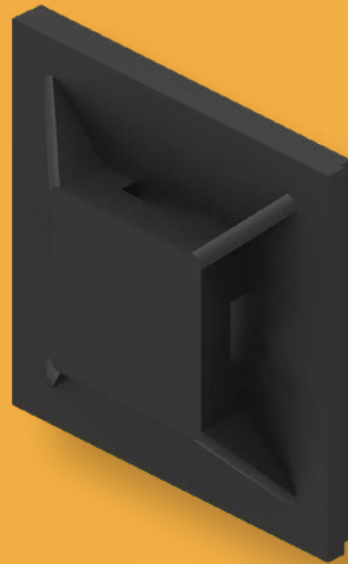
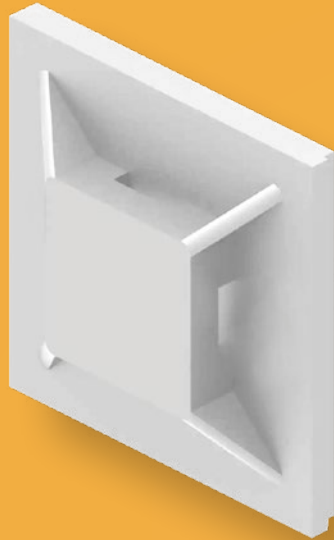

AMMO#	SIZE	COLOR	TYPE	PKG
ARMP4A	25mm x 25mm	White	Adhesive	50
ARMP4AB	25mm x 25mm	Black	Adhesive	50

ELECTRICAL FITTINGS

222

Screw Type Nylon Cable Tie Mounting Platforms



AMMO#	SIZE	COLOR	TYPE	PKG
ARMP4S	28mm x 28mm	White	Screw	50
ARMP4SB	28mm x 28mm	Black	Screw	25

Cable & Conduit _____	226
Beams & Purlins _____	236
Acoustical _____	239
Hanging & Hanging Support _____	241
Datacomm _____	243
Stud & Drywall _____	245

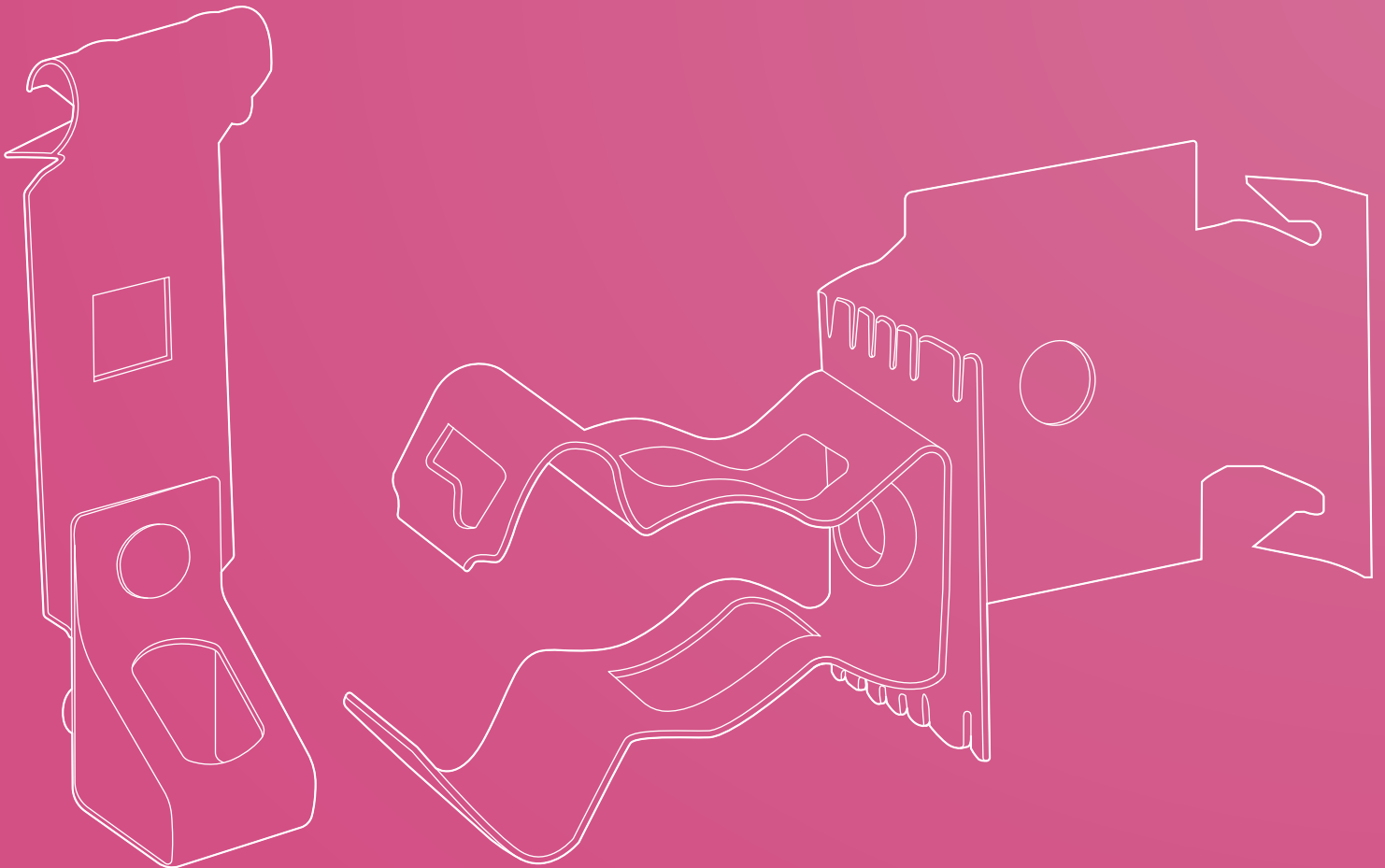



SPRING STEEL FASTENERS



Cable & Conduit

Flange Side Mount Conduit Clip-Push In



AMMO#	FLANGE SIZE	CONDUIT SIZE	INNER	MASTER
A8P24SM	1/8" - 1/4"	1/2"	50	100
A8P58SM	5/16" - 1/2"	1/2"	50	100
A8P912SM	9/16" - 3/4"	1/2"	50	100
A12P24SM	1/8" - 1/4"	3/4"	50	100
A12P58SM	5/16" - 1/2"	3/4"	50	100
A12P912SM	9/16" - 3/4"	3/4"	50	100
A16P24SM	1/8" - 1/4"	1"	50	100
A16P58SM	5/16" - 1/2"	1"	50	100
A16P912SM	9/16" - 3/4"	1"	50	100

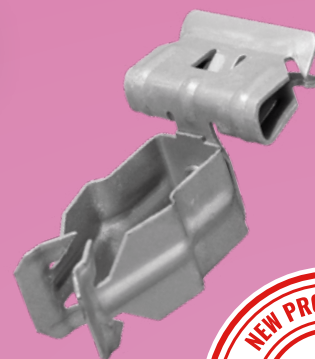

Flange Mount Conduit Clip Push-In



AMMO#	FLANGE SIZE	CONDUIT SIZE	INNER	MASTER
A8P24	1/8" - 1/4"	1/2"	50	100
A8P58	5/16" - 1/2"	1/2"	50	100
A8P912	9/16" - 3/4"	1/2"	50	100
A12P24	1/8" - 1/4"	3/4"	50	100
A12P58	5/16" - 1/2"	3/4"	50	100
A12P912	9/16" - 3/4"	3/4"	50	100
A16P24	1/8" - 1/4"	1"	50	100
A16P58	5/16" - 1/2"	1"	50	100
A16P912	9/16" - 3/4"	1"	50	100

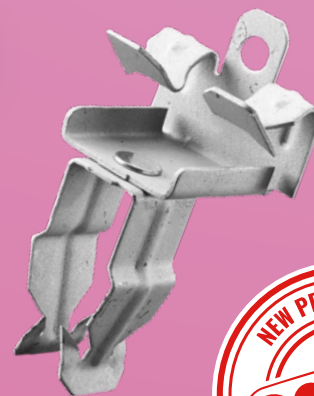

Introducing our Conduit Flange Mount Clips: secure EMT and rigid conduit from beams with a 360° rotatable joint for flexible and efficient installations.



Cable & Conduit

Hammer on Plain Threaded Rod Hangers 3/8" Rod



Innovative solutions for your project! This adjustable hanger suspends threaded rods from beams with just a hammer, allowing for a perfect vertical drop and swivel.

AMMO#	SIZE	PKG
A6A24	1/8"-1/4"	100
A6A912	9/16"-3/4"	100



Hammer on Plain Threaded Rod Hangers 1/4" Rod



Effortlessly support plain rods from beams with our flange clip—installation requires just a hammer! Simple, secure, and swift.

AMMO#	SIZE	PKG
A4TI24	1/8"-1/4"	100
A4TI58	5/16"-1/2"	100
A4TI912	9/16"-3/4"	100

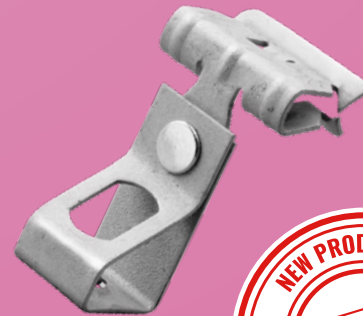

Cable & Conduit

Flange Mount Conduit Clip Sidemount



Easily mount EMT and rigid conduit with our snap-close clamps. Rotates 360° and installs with just a hammer!

AMMO#	FLANGE SIZE	CONDUIT SIZE	PKG
A6M24SM	1/8"-1/4"	3/8"	100
A6M58SM	5/16"-1/2"	3/8"	100
A6M912SM	9/16"-3/4"	3/8"	100
A812M24SM	1/8"-1/4"	1/2" - 3/4"	100
A812M58SM	5/16"-1/2"	1/2" - 3/4"	100
A812M912SM	9/16"-3/4"	1/2" - 3/4"	100
A16M24SM	1/8"-1/4"	1"	100
A16M58SM	5/16"-1/2"	1"	100
A16M912SM	9/16"-3/4"	1"	100
A20M24SM	1/8"-1/4"	1 1/4"	100
A20M58SM	5/16"-1/2"	1 1/4"	100
A20M912SM	9/16"-3/4"	1 1/4"	100
A24M24SM	1/8"-1/4"	1 1/2"	100
A24M58SM	5/16"-1/2"	1 1/2"	100
A24M912SM	9/16"-3/4"	1 1/2"	100
A32M24SM	1/8"-1/4"	2"	100
A32M58SM	5/16"-1/2"	2"	100
A32M912SM	9/16"-3/4"	2"	100

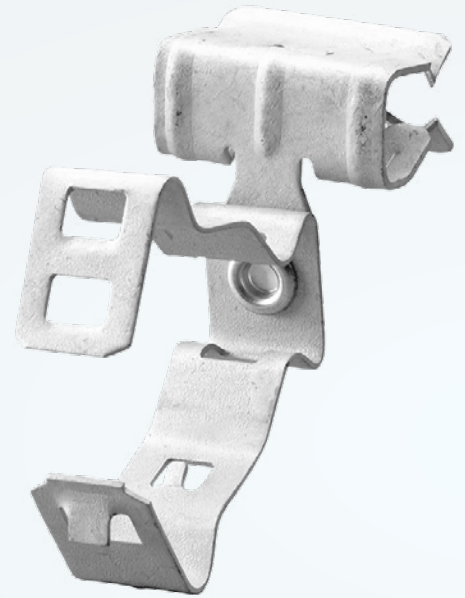

Cable & Conduit

Flange Mount Conduit Clip



 The 360° rotatable conduit flange mount clamps support EMT and rigid conduit from beams and need only a hammer for installation.

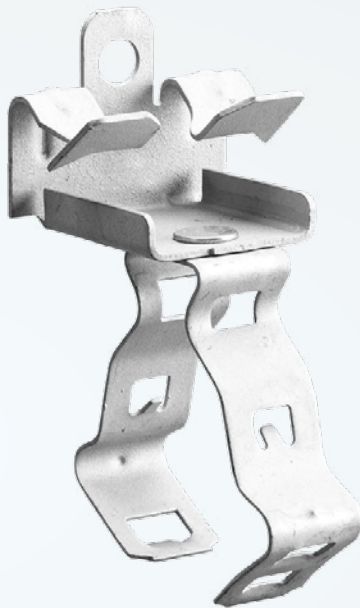

AMMO#	FLANGE SIZE	CONDUIT SIZE	INNER	MASTER
A6M24	1/8"-1/4"	3/8"	50	100
A6M58	5/16"-1/2"	3/8"	50	100
A6M912	9/16"-3/4"	3/8"	50	100
A812M24	1/8"-1/4"	1/2" - 3/4"	50	100
A812M58	5/16"-1/2"	1/2" - 3/4"	50	100
A812M912	9/16"-3/4"	1/2" - 3/4"	50	100
A16M24	1/8"-1/4"	1"	50	100
A16M58	5/16"-1/2"	1"	50	100
A16M912	9/16"-3/4"	1"	50	100
A20M24	1/8"-1/4"	1 1/4"	50	100
A20M58	5/16"-1/2"	1 1/4"	50	100
A20M912	9/16"-3/4"	1 1/4"	50	100
A24M24	1/8"-1/4"	1 1/2"	50	100
A24M58	5/16"-1/2"	1 1/2"	50	100
A24M912	9/16"-3/4"	1 1/2"	50	100
A32M24	1/8"-1/4"	2"	50	100
A32M58	5/16"-1/2"	2"	50	100
A32M912	9/16"-3/4"	2"	50	100



Cable & Conduit



Conduit Hangers



AMMO#	CONDUIT SIZE	CABLE SIZE	WIRE SIZE	PKG
AKX	-	14-2 to 12-3	#12 - #10 - #9 - #8	100
AK8	1/2" EMT - 1/2" Rigid	12-3	#10 - #9 - #8	100
AK12	3/4" EMT - 1/2", 3/4" Rigid	-	#12 - #10 - #9 - #8	100
AK16	3/4", 1" EMT - 1/2", 3/4" Rigid	-	#8 - #9	100
AK20	1", 1 1/4" EMT - 3/4", 1" Rigid	-	#8 - #9	100

Conduit Clips



AMMO#	CONDUIT SIZE	HOLE	INNER	MASTER
A6M	3/8"	9/32" plain	-	100
A812M	1/2" - 3/4"	9/32" plain	-	100
A16M	1"	9/32" plain	-	100
A20M	1 1/4"	9/32" plain	-	100
A24M	1 1/2"	9/32" plain	-	100
A32M	2"	9/32" plain	-	100
A6M4I	3/8"	1/4" threaded impression	-	100
A812M4I	1/2" - 3/4"	1/4" threaded impression	-	100
A16M4I	1"	1/4" threaded impression	50	100
A20M4I	1 1/4"	1/4" threaded impression	50	100
A24M4I	1 1/2"	1/4" threaded impression	-	100
A32M4I	2"	1/4" threaded impression	-	100



Cable & Conduit

Multi-Function Clip



AMMO#	CONDUIT SIZE	WIRE SIZE	ROD SIZE	INNER	MASTER
A4Z34	-	#12 - #8	1/4" - 3/8"	-	100
A4Z4S	-	#12 - #8	1/4" - 3/8"	-	100
A4Z348P	1/2" EMT	#12 - #8	1/4" - 3/8"	50	100
A4Z3412P	3/4" EMT - 1/2" Rigid	#12 - #8	1/4" - 3/8"	50	100
A4Z3416P	1" EMT - 3/4" Rigid	#12 - #8	1/4" - 3/8"	50	100
A6Z348P	1/2" EMT	-	3/8"	50	100
A6Z3412P	4" EMT, 1/2" Rigid	-	3/8"	50	100
A6Z3416P	1" EMT, 3/4" Rigid	-	3/8"	50	100
A4Z34812M	1/2", 3/4" EMT	#12	1/4"	50	100
A4Z3416M	1/2", 3/4" EMT	#12 - #8	1/4" - 3/8"	50	100
A4Z346M	-	#12 - #8	1/4" - 3/8"	50	100
A6Z34812M	1/2" EMT - 1/2" Rigid	-	3/8"	50	100
A6Z3416M	1" EMT	-	3/8"	50	100



• A4Z34



• A4Z4S



- A4Z34812M
- A4Z3416M
- A4Z346M
- A6Z34812M
- A6Z3416M

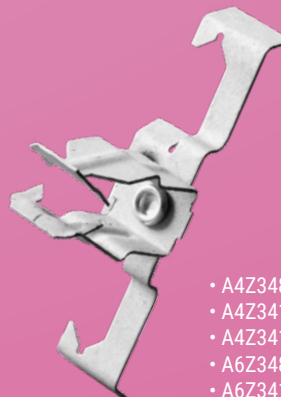

- A4Z348P
- A4Z3412P
- A4Z3416P
- A6Z348P
- A6Z3412P
- A6Z3416P



Cable & Conduit

Conduit Hangers

Zinc
Plated Steel



AMMO#	TRADE SIZE	BOLT SIZE	EMT	RIGID	PKG
ARCH-50	0	1/4" - 20	1/2"	3/8" - 1/2"	100
ARCH-75	1	1/4" - 20	3/4"	3/4"	100
ARCH-100	2	1/4" - 20	1"	1"	100
ARCH-125	3	1/4" - 20	1-1/4"	1-1/4"	100
ARCH-150	2-1/2	1/4" - 20	1-1/2"	-	100
ARCH-200	5	1/4" - 20	2"	2"	50
ARCH-250	6	5/16" - 18	2-1/2"	2-1/2"	50
ARCH-300	7	5/16" - 18	3"	3"	25
ARCH-350	8	5/16" - 18	3-1/2"	3-1/2"	25
ARCH-400	9	5/16" - 18	4"	4"	25

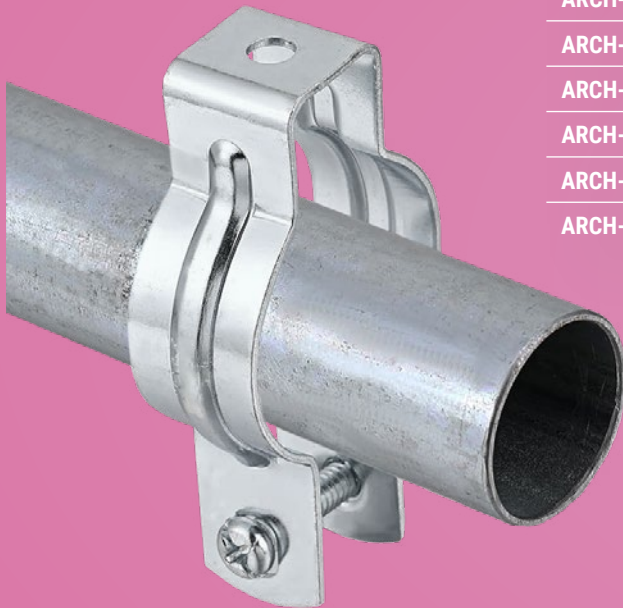

Ideal for wet or dry locations, these mounts securely suspend rigid/IMC and EMT conduit from ceilings and walls, indoors or outdoors, with an easy nut-and-bolt assembly.

Conduit Clips 9/32" Hole Plain



Align EMT and rigid conduit to electrical boxes with push-in clips, supporting vertical and horizontal installations.

AMMO#	CONDUIT SIZE	INNER	MASTER
A8P	1/2"	50	100
A12P	3/4"	50	100
A16P	1"	50	100



SPRING STEEL FASTENERS



Cable & Conduit

MC/AC Cable to Metal Stud



Quickly and easily attach MC/AC cables to metal studs with a tool-free, fast installation solution.

AMMO#	SIZE	PKG
A449	14-2 to 12-3 MC/AC	100
AMAC2	1/8" Max Flange 14-4 to 10-3 MC/AC	100



• A449

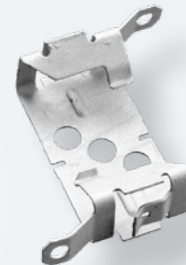

• AMAC2

Non-Metallic Sheathed Cable Clip



Securely supports non-metallic sheathed cable and ground wire to flanges.

AMMO#	SIZE	PKG
ARMX58	14-2, 12-2 NM, 0.28"–0.32" OD, 5/16"–1/2" Flange	100



Cable & Conduit

Cable Snap Clips

Easily snap cable clips onto flanges for quick cable positioning; clip attaches to flange and cable fits securely into the clip.



AMMO#	SIZE	PKG
ASC2A	0.236" - 0.276"	100
ASC2B	0.315" - 0.354"	100
ASC2C	0.394" - 0.433"	100
ASC2D	0.472" - 0.551"	100
ASC2E	0.591" - 0.709"	100
ASC2F	0.748" - 0.945"	100
ASC2G	0.984" - 1.26"	100
ASC4A	0.236" - 0.276"	100
ASC4B	0.315" - 0.354"	100
ASC4C	0.394" - 0.433"	100
ASC4D	0.472" - 0.551"	100
ASC4E	0.591" - 0.709"	100
ASC4F	0.748" - 0.945"	100
ASC4G	0.984" - 1.26"	100



Cable/Conduit to Wire Clip

Support cable and conduit from drop wire effortlessly; ensures no bending and speeds up installation.



AMMO#	SIZE	PKG
APCS1	14-2 to 10-3 MC/AC, .45"-.6" OD, #8-#12 Wire	100



Cable & Conduit

Combination Box Conduit Hangers



Installed to drop wire, drop rod or other structures to support boxes in the center and conduit on either side

AMMO#	SIZE	PKG
A6MB18A	3/8" Flex & Mc/Ac	25
A812MB18S	1/2" - 3/4"	25
A812MB18A	1/2" - 3/4"	25
A16MB18A	3/4" - 1"	25

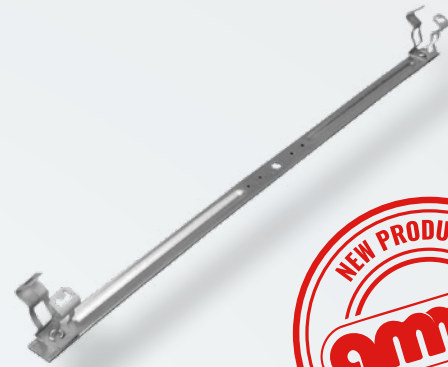

Cable Hangers

AMMO#	SIZE	PKG
AMX3	Diameter 1-1/8"	100
AMX6	Diameter 1-3/4"	100



Miscellaneous

For pipe sizes 6" to 14" use 4H Hammer-On Flange Clip, Side Mount

AMMO#	SIZE	PKG
A740	1.06" x 1.26" x 0.59"	100



Beams & Purlins

Malleable Beam Clamps

Clamp onto structures for conduit hangers; rugged steel/iron with corrosion-resistant zinc plating.



AMMO#	THREAD HOLE	PKG
ARMBC-1024	10 - 24"	50
ARMBC-1420	1/4 - 20"	50
ARMBC-3816	3/8 - 16"	50
ARMBC-1213	1/2 - 13"	25



Steel Beam Clamp

Used to suspend or secure fixtures, wires, threaded rod and other hardware to beam flanges.



AMMO#	THREAD HOLE	PKG
ARBC002	10 - 24" & 1/4 - 20"	100
ARBC001	1/4 - 20"	100

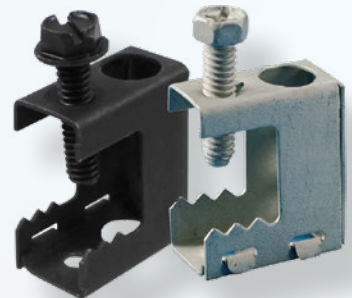

"C" Purlin Clip Vertical

AMMO#	SIZE	PKG
AVF14	1/16" - 1/4"	100



Beams & Purlins

Hammer on Flange Clip

AMMO#	SIZE	PKG
A2H4	3/32" - 9/64"	100
A4H24	1/8" - 1/4"	100
A4H58	5/16" - 1/2"	100
A4H912	9/16" - 3/4"	100

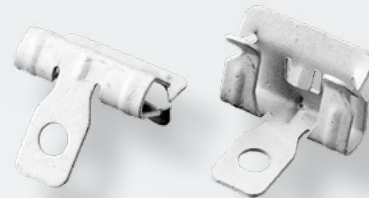

Hammer on Flange Clip Universal

AMMO#	SIZE	PKG
AM24	1/8" - 1/4"	100
AM58	5/16" - 1/2"	100
AM912	9/16" - 3/4"	100



Hammer on Flange Clip Universal with Stud

AMMO#	SIZE	PKG
AM24S	1/8" - 1/4"	100
AM58S	5/16" - 1/2"	100
AM912S	9/16" - 3/4"	100

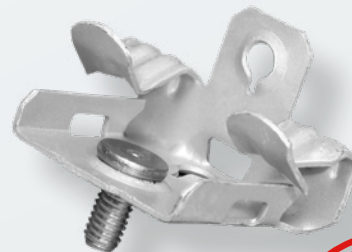

Beams & Purlins

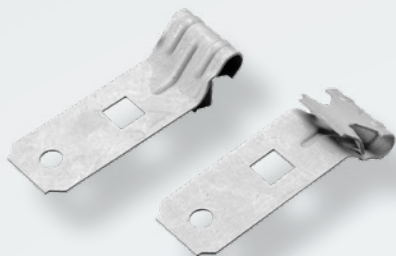

• AAF14

“Z” Purlin Clips-Angular



Hang wires, chains, and hooks from angle purlins with ease; angle flange clip supports secure suspensions from Z purlins.

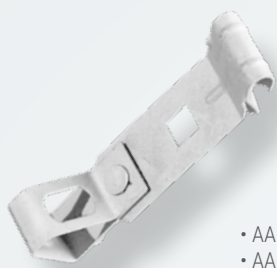

• AAF144TI
• AAF146TI

AMMO#	SIZE	PKG
AAF14	1/16" - 1/4"	100
AAF146TI	1/16" - 1/4"	100
AAF144TI	1/16" - 1/4"	100

“Z” Purlin Clips



Suspend rods securely with a hammer-on clip that conforms to purlin angles.



AMMO#	SIZE	INNER	MASTER
A123812M	for 1/2" to 3/4" EMT, .06 to .1" Flange	50	100
A122	1/4" Hole, 1/16" Max Flange	-	100
A1224TI	for 1/4" threaded rod, 1/16" to 1/4" Flange	50	100
A1226TI	for 3/8" threaded rod, 1/16" to 1/4" Flange	50	100



• A123812M

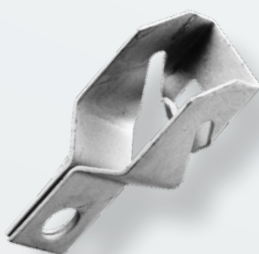

• A122



• A1224TI
• A1226TI

Acoustical

Heavy Duty T-Grid Box Hanger Mounting Clip, Extension Bracket



Mount 2 1/8" or 1 1/2" deep boxes flush with tile on T-grid; adjustable, hand-installed, and supports multiple boxes with added stability.

AMMO#	SIZE	PKG
A512HDEEP	24"	25

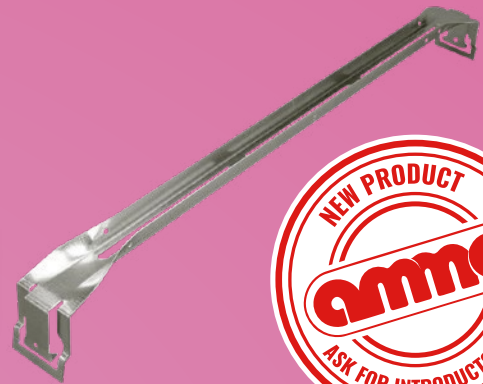

Twist Clip With Wing Nut

Support electrical fixtures on T-Grids with easy, tool-free twist clips; fast, secure installation with included wing nut.



AMMO#	SIZE	PKG
A4G16	0.563" Screw	100



Twist Clip With 90°

Support wire, hooks, or chains from T-Grids with tool-free, twist-on clips for fast, secure installation.



AMMO#	SIZE	PKG
A4G16H	1/4" Plain Hole, 1/16" Max Flange, 15/16" T-Grid	100

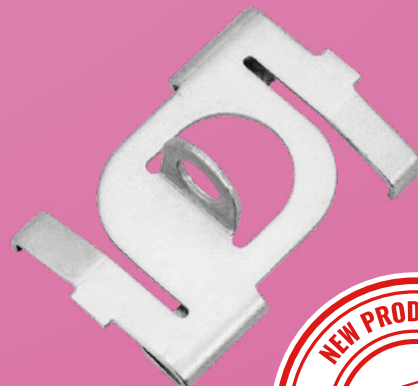

Acoustical

Conduit to T-Grid Clip

Easily secure conduit or cables above T-Grids with tool-free clamps; side mount supports horizontal and vertical attachment.



AMMO#	SIZE	INNER	MASTER
A812MATA	0.709"–1.181"	50	100
A6MATA	0.551" Min, 0.709" Max, 0.552" Nom OD, 3/8" Flexible	50	100

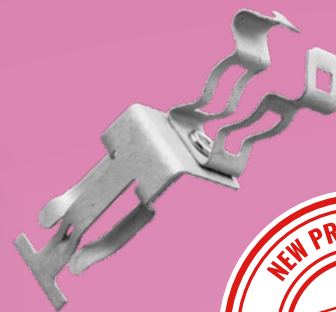

Twist Clip With 90°

Push-in conduit hangers snap onto T-bar grids to support EMT conduit; tool-free, rotates for horizontal or vertical use.



AMMO#	SIZE	INNER	MASTER
A8PATS	1/2" EMT	50	100



T-Grid Clip, Side Mount

Threaded T-Grid Clips mount boxes, conduit, or bridle rings on T-Bar; threaded hole eliminates offset bending.



AMMO#	SIZE	INNER	MASTER
AATS4I	1/4" Hole	50	100



Hanging & Support

Independent Support Clip



Tool-free T-Grid clips support fixtures with ease; includes mounting hardware for independent fixture support.



AMMO#	SIZE	PKG
AIDS	15/16" T-Grid, 0.563" Screw, Washer - Wing nut	100

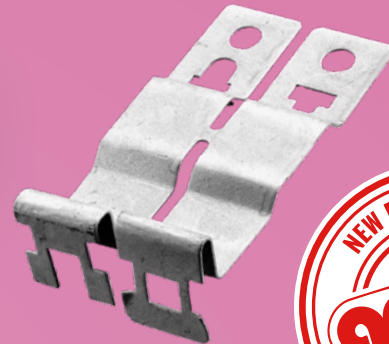

Rod & Wire Hangers



Mounts to wood or concrete to suspend threaded rods from horizontal structures; secure and versatile installation.



AMMO#	SIZE	PKG
A6TIB	1/4" Hole 1, 3/8" Hole 2	100
A4TIB	1/4" Hole 1, 1/4" Hole 2	100
A4TI	3/8" Hole 1, Threaded, 1/4" Hole 2	100
A6TI	3/8" Hole 1, Threaded, 1/4" Hole 2	100
A6T	3/8" Hole 1, Plain, 1/4" Hole 2	100



- A4TIB
- A6TIB

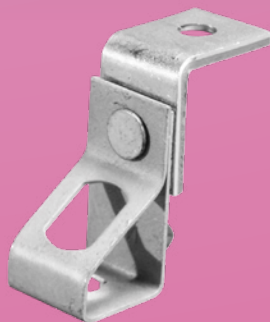

- A4TI
- A6T
- A6TI



Hanging & Support

Strap Hanger for "Z" Purlin Clip



Attach to beam flange to support pipes, ducts, or attachments with straps; secure support with banding or strapping.

AMMO#	SIZE	PKG
AMSS24	0.125" - 0.25"	100
AMSS58	0.3125" - 0.5"	100
AMSS912	0.5625" - 0.75"	100
AMSS122	2.49"	100
AMSR122	3.19"	100
AMSR24	0.125" - 0.25"	100
AMSR58	0.3125" - 0.5"	100

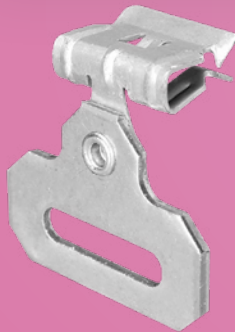

- AMSS24
- AMSS58
- AMSS912

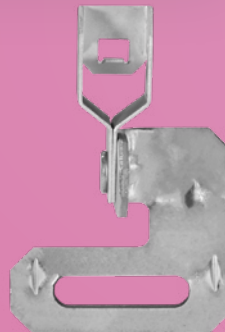

- AMSS122
- AMSR122



- AMSR58
- AMSR24

Brackets



Attach rods, hooks, or chains to concrete or wood; features a 1/4" mounting hole for versatile support.

AMMO#	SIZE	PKG
AAB375	0.25" Hole 1, 0.375" Hole 2	100



Datacomm

J-Hooks



Wall mount J-Hooks support sensitive data cables without stress; cost-effective, wide base design with built-in retainer bar.



- ARJH001
- ARJH002
- ARJH003
- ARJH004



- ACAT124Z34
- ACAT126Z34

AMMO#	SIZE	PKG
ARJH001	3/4"	100
ARJH002	1" - 5/16"	100
ARJH003	2"	100
ARJH004	4"	100
ACAT124Z34	3/8" - 7/16"	100
ACAT126Z34	1/8" - 3/8"	100

Bridle Rings



Support low voltage cables with threaded bridle rings; versatile attachment to flange, purlin, drop wire, and T-grid.



- ARBR125
- ARBR150
- ARBR200
- ARBR400



- ARWBR75
- ARWBR125
- ARWBR150
- ARWBR200
- ARWBR400

AMMO#	SIZE	PKG
ARBR125	1/4-20" x 1-1/4"	100
ARBR150	1/4-20" x 1-1/2"	100
ARBR200	1/4-20" x 2"	100
ARBR400	1/4-20" x 4"	100
ARWBR75	0.75" dia, #10 screw	100
ARWBR125	14" x 1-1/4"	100
ARWBR150	14" x 1-1/2"	100
ARWBR200	14" x 2"	100
ARWBR400	14" x 4"	100

Hanging & Support

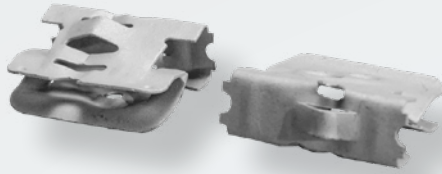

Bridle Ring Clip



Easily attach to flanges to anchor bridle rings and hardware; hammer installation, supports various threaded and unthreaded rings.

AMMO#	SIZE	PKG
A2FMP28	1/8"-1/2" Flange, 1/4", #10 Wire	100

Ceiling Box Support



AMMO#	SIZE	PKG
ARCBS	1" - 2"	50



Wire Basket Tray Clip



Attach cable trays to struts with tray clips; use two clips per 12" basket, no tools or extra hardware needed.

AMMO#	SIZE	PKG
AKBT	3/16" - 5/16"	100

Stud & Drywall

Cable Support to Stud



AMMO#	SIZE	PKG
AFXC20	7/16" - 9/16"	100
ACS812D	1/2", 3/4" EMT, 2 1/8" box depth	100
ACS812	1/2", 3/4" EMT, 1 1/2" box depth	100
ACS16	1" EMT, 2 1/8" box depth	100



• AFXC20



• ACS812
• ACS812D
• ACS16



Conduit to Stud



AMMO#	SIZE	PKG
A6MF	3/8" Flexible, 14-2 TO 12-3 MC/AC	100
A16MF	1" EMT	100
A20MF	1 1/4" EMT	100
A812MF	0.709"-1.181"	100
A350812M	0.709"-1.181"	100



• A350812M

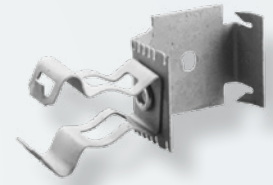

• A6MF
• A16MF
• A20MF
• A812MF



Snap on Nail Plate



AMMO#	SIZE	PKG
A304B2	3 1/8" X 1 1/2"	100



Stud Wall Cable Support



AMMO#	THICKNESS	INNER	MASTER
AMCJ6	0.03"	100	1000

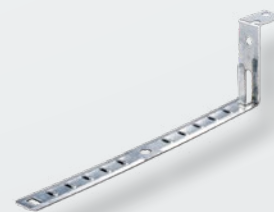

Ground Rod _____	248
Bronze Ground Rod Clamps _____	249
Split Bolts _____	249
Grounding Fittings _____	250
Mechanical Lugs _____	252
Lugs _____	253
Compression Lugs _____	254
Grounding Bushbars _____	258
Ground Screws & Pigtails _____	259

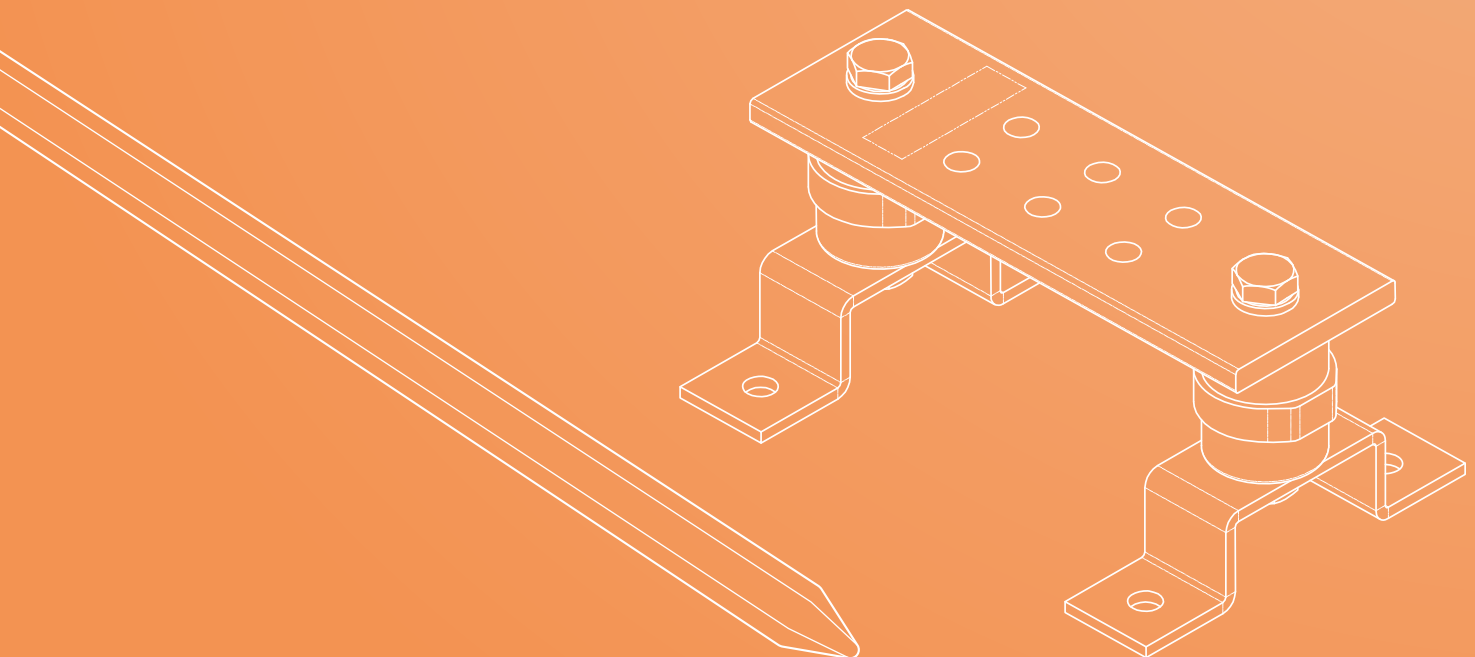



GROUNDING



Ground Rod Pointed 10mil Plating

Offers high strength, excellent corrosion resistance, and good conductivity, making it ideal for lightning protection and grounding systems.



Copper Clad Steel Ground Rod



AMMO#	SIZE	INNER	MASTER
58-8CCSGR	5/8" x 8'	100	300
34-8CCSGR	3/4" x 8'	100	300
58-10CCSGR	5/8" x 10'	100	300
34-10CCSGR	3/4" x 10'	100	300

Copper Clad Steel Ground Rod - Non UL

AMMO#	SIZE	INNER	MASTER
GR58X8-N/UL	5/8" x 8'	100	300

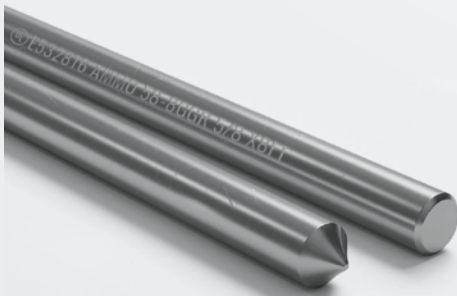

Galvanized Ground Rod



AMMO#	SIZE	INNER	MASTER
58-8GGR	5/8" x 8'	100	300

Bronze Ground Rod Clamps



AMMO#	SIZE	INNER	MASTER
ARBGRC-34	3/4"	50	500
ARBGRC-58	5/8"	50	500

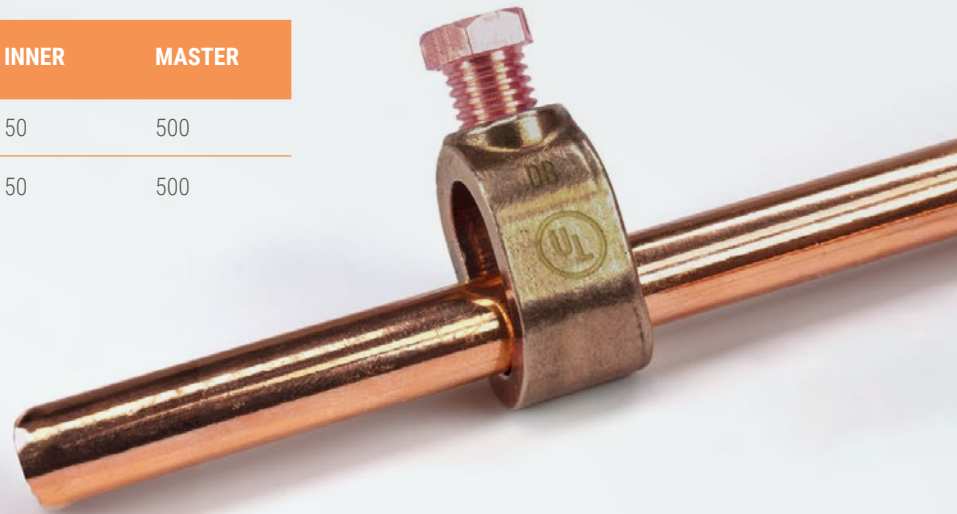

Split Bolt Connectors



AMMO#	SIZE	PKG
ARSB10	10	100
ARSB8	8	100
ARSB6	6	100
ARSB4	4	100
ARSB2	2	100
ARSB1/0	1/0	50
ARSB2/0	2/0	25
ARSB3/0	3/0	25
ARSB4/0-250	4/0-250mcm	25
ARSB350	350mcm	6
ARSB500	500mcm	6



Coming soon!



Grounding Hubs Brass

Includes direct burial



AMMO#	SIZE	INNER	MASTER
AR-HB50	1/2"	-	-
AR-HB75	3/4"	-	-
AR-HB100	1"	-	-

Ground Clamps

Includes direct burial



AMMO#	SIZE	DESCRIPTION	SCREWS	INNER	MASTER
ARGCDB-630DB	1/2" to 1"	For Direct Burial	Bronze	-	-
ARGCBW-626A	1/2" to 1"	For bare wire Standard brass	-	-	-
ARGCBW-626BS	1/2" to 1"	For bare wire Standard brass	Brass	-	-
ARGCBW-626B	1-1/4" to 2"	For bare wire Standard brass	-	-	-
ARGCBW-626C	2-1/2" to 4"	For bare wire Standard brass	-	-	-
ARGCBW-626D	4" to 6"	For bare wire Standard brass	-	-	-
ARGCBW-26A	1/2" to 1"	For bare wire Standard brass	-	10	100
ARGCBW-26B	1-1/4" to 2"	For bare wire Standard brass	-	5	50
ARGCAW-630B	1/2" to 1"	For armored wire brass	-	-	-
ARGCAW-630	1-1/4" to 2"	For armored wire brass	-	-	-
ARGCBW-01Z	1/2" to 1"	For bare wire Zinc die cast	-	-	-

Coming soon!



• ARG CDB-630DB

Coming soon!



- ARG CBW-626A
- ARG CBW-626BS
- ARG CBW-626B
- ARG CBW-626C
- ARG CBW-626D
- ARG BW-26A
- ARG BW-26B

Coming soon!



- ARG CAW-630B
- ARG CAW-630

Coming soon!



- ARG CBW-01Z

Ground Clamps with Threaded Hubs for Rigid Conduit Brass

Includes direct burial



AMMO#	SIZE	HUBS	INNER	MASTER
ARGCH-50A	1/2" to 1"	1/2"	-	-
ARGCH-75A	1/2" to 1"	3/4"	-	-
ARGCH-100A	1/2" to 1"	1"	-	-
ARGCH-50B	1-1/4" to 2"	1/2"	-	-
ARGCH-75B	1-1/4" to 2"	3/4"	-	-
ARGCH-100B	1-1/4" to 2"	1"	-	-



Combination Ground Clamps for Bare Wires lay-in-Lug

Includes direct burial



AMMO#	SIZE	WIDTH	WIRE	INNER	MASTER
ARGCBW-26A	1/2" to 1"	-	-	10	100
ARGCBW-26B	1-1/4" to 2"	-	-	5	50
ARGCBW-625	1/2" to 1"	2.36"	#8 - 4/0	-	-
ARGCBW-626	1/2" to 1"	2.52	#8 - 4/0	-	-
ARGCBW-627	1/2" to 1"	2.28	#10 - #2	-	-
ARGCBW-628	1/2" to 1"	2.28	#10 - #2	-	-

Coming soon!



- ARGCBW-26A
- ARGCBW-26B

Coming soon!



- ARGCBW-625
- ARGCBW-626

Coming soon!



- ARGCBW-627
- ARGCBW-628

Mechanical Lugs Aluminum



Dual-rated for use with both aluminum and copper conductors, this product is rated at 600 V/90°C, accommodates two conductors, and features a single hole mount for easy installation. Single Hole Mount

Lugs Single

AMMO#	BOLT HOLE	WIRE RANGE	INNER	MASTER
ARLS-14-1/0	1/4"	#14 - 1/0	-	-
ARLS-14-2/0	1/4"	#14 - 2/0	-	-
ARLS-14-2	1/4"	#14 - #2	-	-
ARLS-14-6	1/4"	#14 - #6	-	-
ARLS-4-500	5/16"	#4 - 500 MCM	-	-
ARLS-6-4/0	5/16"	#6 - 4/0	-	-
ARLS-6-300	5/16"	#6 - 300 MCM	-	-
ARLS-6-350	5/16"	#6 - 350 MCM	-	-
ARLS-9-600	3/8"	#9 - 600 MCM	-	-
ARLS-350-800	3/8"	350 MCM - 800 MCM	-	-



Coming soon!



Lugs Double - Dual Rated

AMMO#	BOLT HOLE	WIRE RANGE	INNER	MASTER
ARLD-14-1/0	1/4"	#14 - 1/0	-	-
ARLD-14-2/0	1/4"	#14 - 2/0	-	-
ARLD-2-600	1/4"	#2 - 600 MCM	-	-
ARLD-6-250	5/16"	#6 - 250 MCM	-	-
ARLD-6-350	5/16"	#6 - 350 MCM	-	-
ARLD-300-800	3/8"	300 MCM - 800 MCM	-	-



Coming soon!



Lay-in Type Lugs Solderless Lug Aluminum

 With a 90°C temperature rating and single hole assembly, this product ensures positive grounding points in load centers and other enclosures.

AMMO#	WIRE	INNER	MASTER
ARLSA-1	#14 - #4	-	-
ARLSA-2	#14 - 1/0	-	-
ARLSA-3	6 - 250 MCM	-	-

Coming soon!

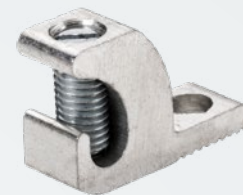

Solderless Lugs Single Hole Copper

 Unique pressure bar ensures a solid grip between the conductor and terminal, with a hole for offset tang mounting.

AMMO#	WIRE	AMP	INNER	MASTER
ARLSH-1	#14 - #10	25	-	-
ARLSH-2	#14 - #6	35	-	-
ARLSH-3	#2 - #8	70	-	-
ARLSH-4	#2 - #6	90	-	-
ARLSH-5	#8 - 1/0	125	-	-
ARLSH-6	#4 - 3/0	175	-	-
ARLSH-7	#6 - 4/0	225	-	-
ARLSH-8	1/0 350 MCM	300	-	-
ARLSH-9	4/0 - 500 MCM	400	-	-
ARLSH-10	600 MCM - 100 MCM	600	-	-

Coming soon!

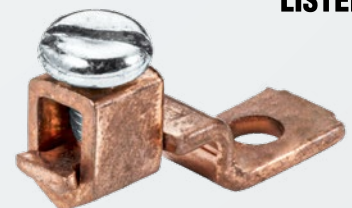



Compression Lugs E-Copper



Chamfered barrel ends for easy entry, electro-tinned to BS standards to prevent corrosion and oxidation, without inspection hole, rated for copper conductors.

Compression Lugs Splices Short barrel



AMMO#	WIRE RANGE	COLOR CODE	INNER	MASTER
ARBARREL-8S	#8	Red	100	1000
ARBARREL-6S	#6	Blue	100	1000
ARBARREL-4S	#4	Gray	100	1000
ARBARREL-2S	#2	Brown	100	1000
ARBARREL-1S	#1	Green	50	500
ARBARREL-10S	1/0	Pink	50	500
ARBARREL-20S	2/0	Black	50	500
ARBARREL-30S	3/0	Orange	50	500
ARBARREL-40S	4/0	Purple	25	250
ARBARREL-250S	250 MCM	Yellow	25	250
ARBARREL-350S	350 MCM	Red	20	200
ARBARREL-400S	400 MCM	Blue	10	100
ARBARREL-500S	500 MCM	Brown	10	100
ARBARREL-600S	600 MCM	Green	5	50
ARBARREL-750S	750 MCM	Black	5	50



GROUNDING

254



+718.338.1851



info@ammoelectric.com



www.ammoelectric.com

Compression Lugs Splices

Long barrel



AMMO#	WIRE RANGE	COLOR CODE	INNER	MASTER
ARBARREL-8L	#8	Red	100	1000
ARBARREL-6L	#6	Blue	100	1000
ARBARREL-4L	#4	Gray	100	1000
ARBARREL-2L	#2	Brown	50	500
ARBARREL-10L	1/0	Pink	25	250
ARBARREL-20L	2/0	Black	25	250
ARBARREL-30L	3/0	Orange	25	250
ARBARREL-40L	4/0	Purple	25	250
ARBARREL-250L	250 MCM	Yellow	10	100
ARBARREL-300L	300 MCM	White	10	100
ARBARREL-350L	350 MCM	Red	10	100
ARBARREL-400L	400 MCM	Blue	10	100
ARBARREL-500L	500 MCM	Brown	5	50
ARBARREL-600L	600 MCM	Green	5	50
ARBARREL-750L	750 MCM	Black	5	50

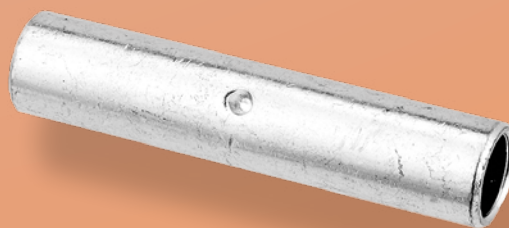



Compression Lugs Bolt One Hole, Short barrel



AMMO#	STUD SIZE	WIRE RANGE	COLOR CODE	INNER	MASTER
ARBOLT1-810S	1/4"	#8	Red	100	1000
ARBOLT1-825S	1/4"	#8	Red	100	1000
ARBOLT1-625S	1/4"	#6	Blue	100	1000
ARBOLT1-6516S	5/16"	#6	Blue	100	1000
ARBOLT1-425S	1/4"	#4	Grey	100	1000
ARBOLT1-4516S	5/16"	#4	Grey	100	1000
ARBOLT1-438S	3/8"	#4	Grey	100	1000
ARBOLT1-238S	3/8"	#2	Brown	100	1000
ARBOLT1-138S	3/8"	#1	Green	100	1000
ARBOLT1-1038S	3/8"	1/0	Pink	50	500
ARBOLT1-2038S	3/8"	2/0	Black	50	500
ARBOLT1-2050S	1/2"	2/0	Black	50	500
ARBOLT1-3038S	3/8"	3/0	Orange	25	250
ARBOLT1-4050S	1/2"	4/0	Purple	25	250
ARBOLT1-25050S	1/2"	250	Yellow	25	250
ARBOLT1-30050S	1/2"	300	White	25	250
ARBOLT1-35050S	1/2"	350	Red	20	200
ARBOLT1-40050S	1/2"	400	Blue	10	100
ARBOLT1-50050S	1/2"	500	Brown	10	100
ARBOLT1-60050S	1/2"	600	Green	5	50
ARBOLT1-75058S	5/8"	750	Black	5	50



Compression Lugs Bolt One Hole, Long barrel



AMMO#	STUD SIZE	WIRE RANGE	COLOR CODE	INNER	MASTER
ARBOLT1-825L	1/4"	#8	Red	100	1000
ARBOLT1-625L	1/4"	#6	Blue	100	1000
ARBOLT1-425L	1/4"	#4	Grey	100	1000
ARBOLT1-238L	3/8"	#2	Brown	50	500
ARBOLT1-138L	3/8"	#1	Green	50	500
ARBOLT1-1038L	3/8"	1/0	Pink	50	500
ARBOLT1-2038L	3/8"	2/0	Black	25	250
ARBOLT1-3038L	3/8"	3/0	Orange	25	250
ARBOLT1-3050L	1/2"	3/0	Orange	25	250
ARBOLT1-4050L	1/2"	4/0	Purple	25	250
ARBOLT1-25050L	1/2"	250	Yellow	20	200
ARBOLT1-30050L	1/2"	300	White	10	100
ARBOLT1-35050L	1/2"	350	Red	10	100
ARBOLT1-40050L	1/2"	400	Blue	10	100
ARBOLT1-50050L	1/2"	500	Brown	5	50
ARBOLT1-60058L	5/8"	600	Green	5	50
ARBOLT1-75058L	5/8"	750	Black	5	50



Compression Lugs Bolt Two Hole, Short barrel



AMMO#	STUD SIZE	WIRE RANGE	COLOR CODE	INNER	MASTER
ARBOLT2-810S	1/4"	#8	Red	10	1000
ARBOLT2-625S	1/4"	#6	Blue	10	1000
ARBOLT2-425S	1/4"	#4	Grey	10	1000
ARBOLT2-2516S	5/16"	#2	Brown	50	500
ARBOLT2-2050S	1/2"	2/0	Black	25	250
ARBOLT2-3050S	1/2"	3/0	Orange	25	250
ARBOLT2-4050S	1/2"	4/0	Purple	25	250
ARBOLT2-25050S	1/2"	250	Yellow	20	200
ARBOLT2-30050S	1/2"	300	White	10	100
ARBOLT2-35050S	1/2"	450	Red	10	100
ARBOLT2-40050S	1/2"	400	Blue	10	100
ARBOLT2-50050S	1/2"	500	Brown	5	50
ARBOLT2-60038S	3/8"	600	Green	5	50
ARBOLT2-75050S	1/2"	750	Black	5	50

Compression Lugs Bolt Two Hole, Long barrel



AMMO#	STUD SIZE	WIRE RANGE	COLOR CODE	INNER	MASTER
ARBOLT2-825L	1/4"	#8	Red	100	1000
ARBOLT2-625L	1/4"	#6	Blue	100	1000
ARBOLT2-425L	1/4"	#4	Grey	100	1000
ARBOLT2-250L	1/2"	#2	Brown	50	500
ARBOLT2-1050L	1/2"	1/0	Pink	25	250
ARBOLT2-2050L	1/2"	2/0	Black	25	250
ARBOLT2-3050L	1/2"	3/0	Orange	20	200
ARBOLT2-4050L	1/2"	4/0	Purple	10	100
ARBOLT2-25050L	1/2"	250	Yellow	10	100
ARBOLT2-30050L	1/2"	300	White	10	100
ARBOLT2-35050L	1/2"	350	Red	10	100
ARBOLT2-40050L	1/2"	400	Blue	5	50
ARBOLT2-50050L	1/2"	500	Brown	5	50
ARBOLT2-60012L	1/2"	600	Green	5	50
ARBOLT2-75012L	1/2"	750	Black	5	50

Grounding Bushbars Zinc Plated

Busbar provides a central point for equipment ground connections.

AMMO#	SIZE	PKG
GB2-6	2" x 6" x 1/4"	20
GB2-12	2" x 12" x 1/4"	10
GB4-12	4" x 12" x 1/4"	10
GB4-24	4" x 24" x 1/4"	4

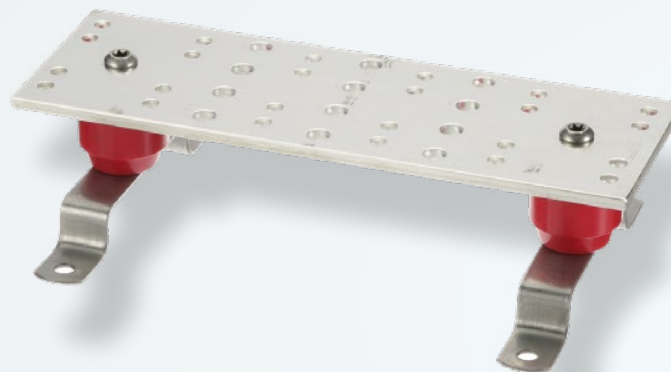

Rooftop Block Support Single Base With Channel

AMMO#	SIZE	PKG
ARSB-01	10.63" x 5.9" x 3.94"	2



Green Ground Screw

Grounding screws establish a secure electrical path to ground, enhancing safety by preventing electrical shock.



AMMO#	SIZE	INNER	MASTER
AR973	10-32" x 3/8", Slotted Head #10-32 Threads	100	1000



Green Ground Screw with Insulated Solid Copper Wire

Utilize to connect receptacles to metal enclosures.

AMMO#	SIZE	WIRE	INNER	MASTER
AR996	10-32" x 3/8"	#12 AWG Insulated Solid Copper Wire	100	1000

Stranded with One End of Fork & other End Terminal Rings with Screw

Utilize to connect receptacles to metal enclosures.

AMMO#	SIZE	WIRE	INNER	MASTER
PT12STGN	10-32" x 3/8"	#12 AWG	100	1000



Threaded Rod _____	262
Strut Channels _____	263
Strut Fittings _____	265
Strut Clamps _____	266
Spring Nuts _____	267
Fitting Threaded Rod _____	268

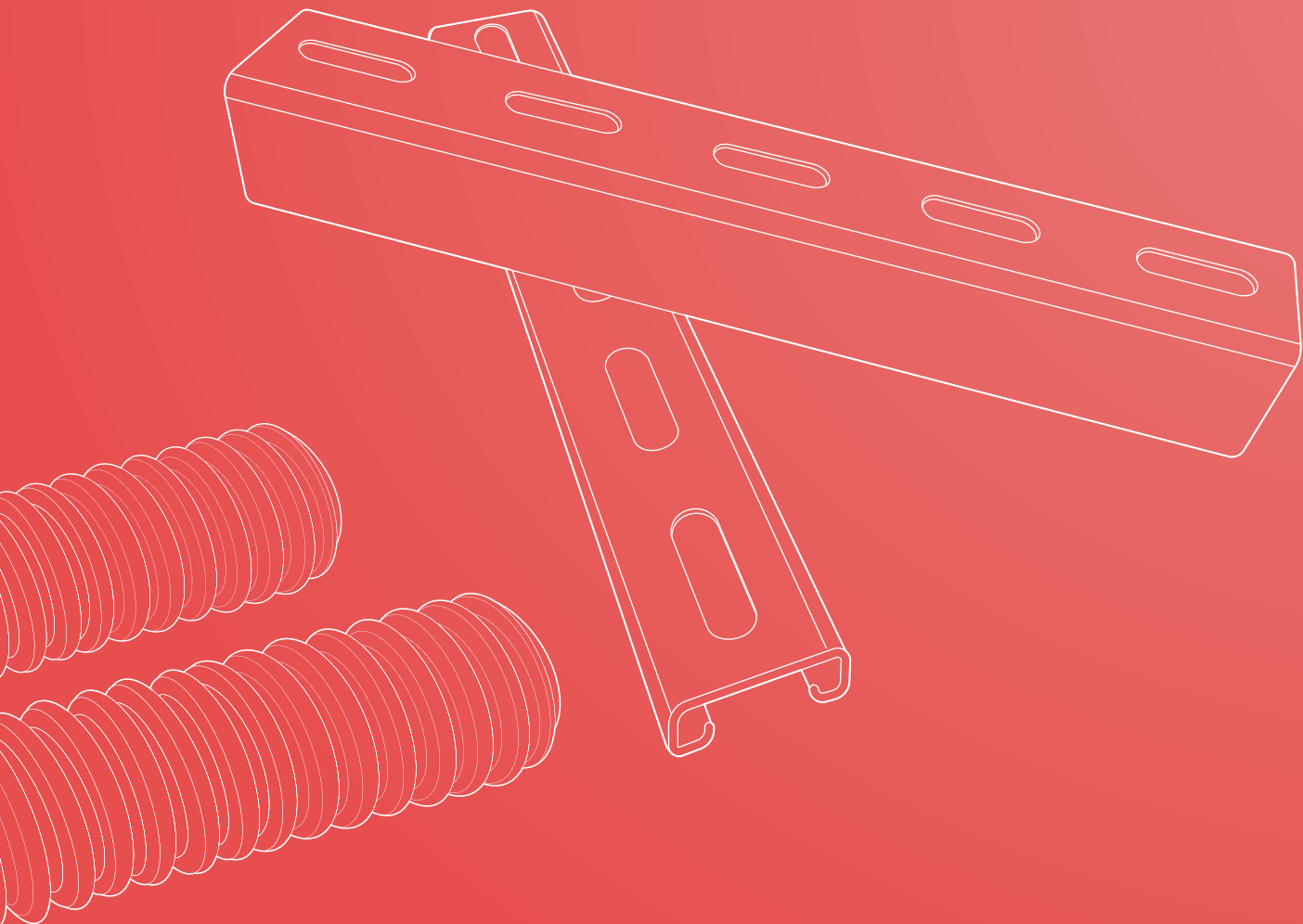



STRUT & THREADED ROD





Threaded Electrical Support Rods

Galvanized
Zinc Plated

AMMO#	SIZE	PKG
ARTR146	1/4" x 6'	50
ARTR148	1/4" x 8'	50
ARTR1410	1/4" x 10'	50
ARTR386	3/8" x 6'	25
ARTR388	3/8" x 8'	25
ARTR3810	3/8" x 10'	25
ARTR126	1/2" x 6'	12
ARTR128	1/2" x 8'	12
ARTR1210	1/2" x 10'	12
ARTR586	5/8" x 6'	8
ARTR588	5/8" x 8'	8
ARTR5810	5/8" x 10'	8
ARTR346	3/4" x 6'	5
ARTR348	3/4" x 8'	5
ARTR3410	3/4" x 10'	5



For hanging HVAC, plumbing, and electrical components, our assemblies use sturdy support members and reliable fasteners. Threaded rods are securely packed in cardboard tubes and placed on pallets for shipping.



STRUT & THREADED ROD

Strut Channels



Ideal for mounting, bracing, supporting, and connecting lightweight structural loads in building construction, including pipes, electrical and data wiring, as well as mechanical systems like ventilation and air conditioning.

Oval Slotted - 10ft *Pre-Galvanized*

AMMO#	SIZE (mm)	WIDTH	HEIGHT	GAUGE	PKG
ARSTSL-1-5/8-12-10FT-PG	41 x 21 x 2.5	1-5/8"	1-5/8"	12	50
ARSTSL-1-5/8-14-10FT-PG	41 x 41 x 2.5	1-5/8"	1-5/8"	14	50
ARSTSL-13/16-12-10FT-PG	41 x 21 x 2	1-5/8"	13/16"	12	50
ARSTSL-13/16-14-10FT-PG	41 x 41 x 2	1-5/8"	13/16"	14	50



Oval Slotted - 20ft *Pre-Galvanized*

AMMO#	SIZE (mm)	WIDTH	HEIGHT	GAUGE	PKG
ARSTSL-1-5/8-12-20FT-PG	41 x 21 x 2.5	1-5/8"	1-5/8"	12	50
ARSTSL-1-5/8-14-20FT-PG	41 x 41 x 2.5	1-5/8"	1-5/8"	14	50
ARSTSL-13/16-12-20FT-PG	41 x 21 x 2	1-5/8"	13/16"	12	50
ARSTSL-13/16-14-20FT-PG	41 x 41 x 2	1-5/8"	13/16"	14	50

Oval Slotted - 10ft *Hot Dip Galvanized*

AMMO#	WIDTH	HEIGHT	GAUGE	PKG
ARSTSL-1-5/8-12-10FT-HDG	1-5/8"	1-5/8"	12	50
ARSTSL-1-5/8-14-10FT-HDG	1-5/8"	1-5/8"	14	50
ARSTSL-13/16-12-10FT-HDG	1-5/8"	13/16"	12	50
ARSTSL-13/16-14-10FT-HDG	1-5/8"	13/16"	14	50

Oval Slotted - 20ft *Hot Dip Galvanized*

AMMO#	WIDTH	HEIGHT	GAUGE	PKG
ARSTSL-1-5/8-12-20FT-HDG	1-5/8"	1-5/8"	12	50
ARSTSL-1-5/8-14-20FT-HDG	1-5/8"	1-5/8"	14	50
ARSTSL-13/16-12-20FT-HDG	1-5/8"	13/16"	12	50
ARSTSL-13/16-14-20FT-HDG	1-5/8"	13/16"	14	50

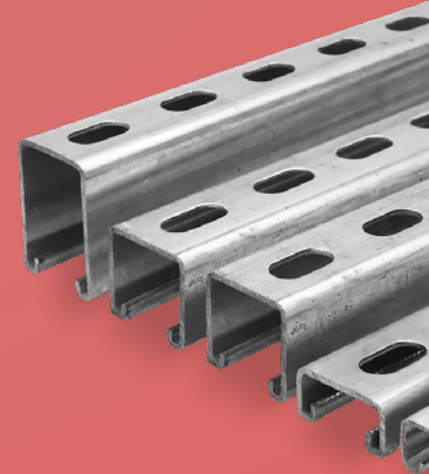



Solid - 10ft *Hot Dip Galvanized*

AMMO#	WIDTH	HEIGHT	GAUGE	PKG
ARSTSO-1-5/8-12-10FT-HDG	1-5/8"	1-5/8"	12	50
ARSTSO-13/16-12-10FT-HDG	1-5/8"	13/16"	12	50

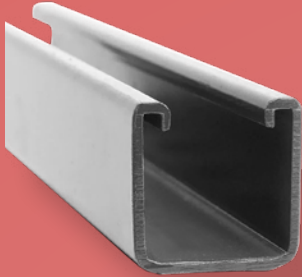

Solid - 20ft *Hot Dip Galvanized*

AMMO#	WIDTH	HEIGHT	GAUGE	PKG
ARSTSO-1-5/8-12-20FT-HDG	1-5/8"	1-5/8"	12	50
ARSTSO-13/16-12-20FT-HDG	1-5/8"	13/16"	12	50

Solid, Back to Back - 10ft *Hot Dip Galvanized*

AMMO#	WIDTH	HEIGHT	GAUGE	PKG
ARSTSO-1-5/8-12-10FT-HDG-BTB	1-5/8"	1-5/8"	12	25
ARSTSO-13/16-12-10FT-HDG-BTB	1-5/8"	13/16"	12	25

Solid, Back to Back - 20ft *Hot Dip Galvanized*

AMMO#	WIDTH	HEIGHT	GAUGE	PKG
ARSTSO-1-5/8-12-20FT-HDG-BTB	1-5/8"	1-5/8"	12	25
ARSTSO-13/16-12-20FT-HDG-BTB	1-5/8"	13/16"	12	25

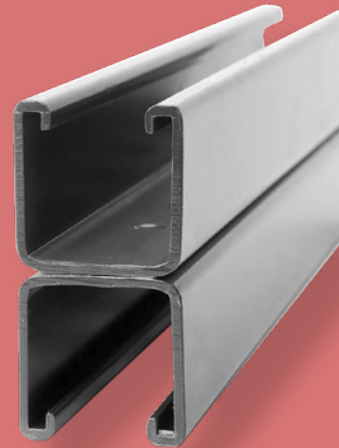

Oval Slotted, Back to Back - 10ft *Hot Dip Galvanized*

AMMO#	WIDTH	HEIGHT	GAUGE	PKG
ARSTSL-1-5/8-12-10FT-HDG-BTB	1-5/8"	1-5/8"	12	25
ARSTSL-13/16-12-10FT-HDG-BTB	1-5/8"	13/16"	12	25

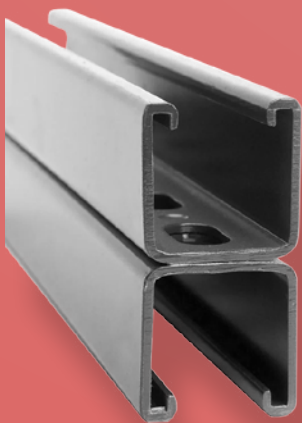

Oval Slotted, Back to Back - 20ft *Hot Dip Galvanized*

AMMO#	WIDTH	HEIGHT	GAUGE	PKG
ARSTSL-1-5/8-12-20FT-HDG-BTB	1-5/8"	1-5/8"	12	25
ARSTSL-13/16-12-20FT-HDG-BTB	1-5/8"	13/16"	12	25

STRUT & THREADED ROD

Strut Fittings

AMMO#	DESCRIPTION	PKG
ARSFP01	4 Hole Splice Plate	5
ARSFP02	3 Hole Corner Plate - Flat	25
ARSFP03	4 Hole Tee Plate - Flat	20
ARSFP04	2 Hole Corner Angle	50
ARSFP05	4 Hole Corner Angle	25
ARSFP06	4 Hole Open 45° Corner Angle	25
ARSFP07	13/16" 4h U-Fitting Splice	10
ARSFP08	Post Base Sngl Chan 3-1/2" 2h	5
ARSFP09	Post Base Sngl Chan 3-1/2" 4h	5



ARSFP01

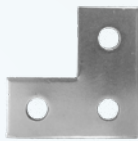

ARSFP02



ARSFP03



ARSFP04



ARSFP05



ARSFP06



ARSFP07

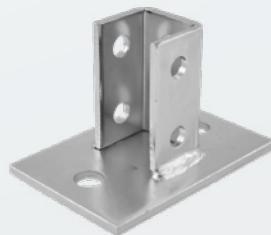

ARSFP08

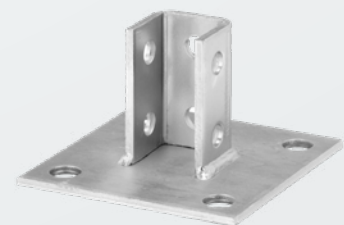

ARSFP09

EMT & Rigid Strut Clamps Steel Zinc Plated

For EMT, Rigid, and IMC conduit, using 5/16" x 1-1/4" slotted hex head screws to support pipe and tubing from strut channels.

AMMO#	SIZE	PKG
ARSTCP-50	1/2"	100
ARSTCP-75	3/4"	100
ARSTCP-100	1"	100
ARSTCP-125	1-1/4"	100
ARSTCP-150	1-1/2"	50
ARSTCP-200	2"	50
ARSTCP-250	2-1/2"	50
ARSTCP-300	3"	25
ARSTCP-350	3-1/2"	25
ARSTCP-400	4"	25



EMT One Piece Strut Clamps with saddle Steel Zinc Plated

One-Piece Strut Clamps are the fastest method of attaching EMT or flexible conduit to channel.



AMMO#	SIZE	PKG
ARSTC0038	3/8"	100
ARSTC001	1/2"	100
ARSTC002	3/4"	100
ARSTC003	1"	50
ARSTC004	1-1/4"	50
ARSTC005	1-1/2"	50
ARSTC006	2"	50
ARSTC007	2-1/2"	50
ARSTC008	3"	25
ARSTC009	3-1/2"	25
ARSTC010	4"	25

Spring Nuts

Spring Steel



Channel Nuts for Strut Channels install quickly, resist pull-out, and feature a silver finish with wedging teeth.



AMMO#	SIZE	PKG
ARSN1420-R	1/4" Reg Spring	100
ARSN1420-S	1/4" Short Spring	100
ARSN3816-R	3/8" Reg Spring	100
ARSN3816-S	3/8" Short Spring	100
ARSN1213-R	1/2" Reg Spring	100
ARSN1213-S	1/2" Short Spring	100



Channel Cone Nuts

Electroplated Zinc



Cone Channel Nuts ensure easy positioning, compatibility, and prevent twisting or binding



AMMO#	SIZE	THREAD	PKG
ARSNCN1420	1/4"	20	100
ARSNCN3816	3/8"	16	100
ARSNCN1213	1/2"	13	100



Strut Channel Covers

PVC

AMMO#	LENGTH	INNER	MASTER
ARSTC-10FT	10FT	20	1000
ARSTC-20FT	20FT	20	500





USS Flat Washers Low carbon steel



A washer distributes the load of threaded fasteners, preventing loosening, with thin steel rings used for load distribution, while lock washers provide added security.

AMMO#	SIZE	INNER	MASTER
ARFW38	3/8"	100	500
ARFW14	1/4"	100	500
ARFW12	1/2"	100	500
ARFW58	5/8"	100	500
ARFW34	3/4"	100	1000



STRUT & THREADED ROD

UNC Hexagon Nuts Grade 2 Low carbon steel

Hex nuts, ideal for high-strength threaded fastening in structural applications and cell tower modifications, secure materials together with bolts and are available in zinc, plain, stainless steel, and galvanized finishes for durable performance.

AMMO#	SIZE	INNER	MASTER
ARUHN14	1/4"	100	500
ARUHN38	3/8"	100	500
ARUHN12	1/2"	50	250
ARUHN58	5/8"	50	250
ARUHN34	3/4"	50	250



Cat 5 Wire _____	272
Cat 6 Wire _____	272
RG6 Dual/Quad _____	274
THHN Wire Stranded _____	275
THHN Wire Solid _____	287





ELECTRICAL WIRE

ammo



Category Cable



CAT5E-CCA-B

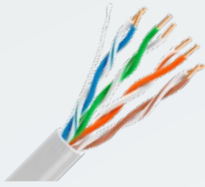

CAT5E-CCA-W



CAT5E-CCA-GN

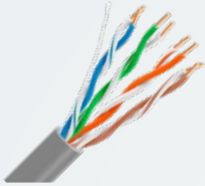

CAT5E-CCA-GY

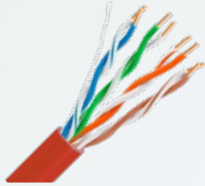

CAT5E-CCA-R

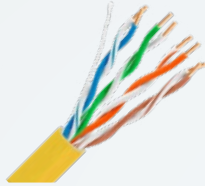

CAT5E-CCA-Y

CAT5 Wire



AMMO#	COLOR	PKG
CAT5E-CCA-B	Blue	1000/box
CAT5E-CCA-W	White	1000/box
CAT5E-CCA-GN	Green	1000/box
CAT5E-CCA-GY	Gray	1000/box
CAT5E-CCA-R	Red	1000/box
CAT5E-CCA-Y	Yellow	1000/box

CAT6 Wire



AMMO#	COLOR	PKG
CAT6-CCA-B	Blue	1000/box
CAT6-CCA-W	White	1000/box
CAT6-CCA-GN	Green	1000/box
CAT6-CCA-GY	Gray	1000/box
CAT6-CCA-R	Red	1000/box
CAT6-CCA-Y	Yellow	1000/box

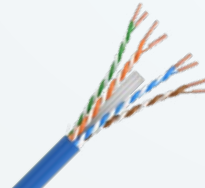

CAT6-CCA-B

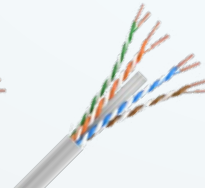

CAT6-CCA-W

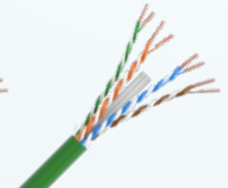

CAT6-CCA-GN

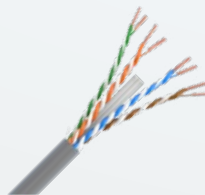

CAT6-CCA-GY

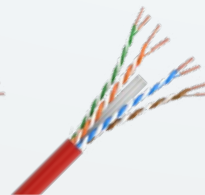

CAT6-CCA-R

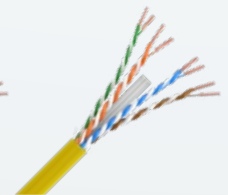

CAT6-CCA-Y

CAT6E Wire

Fluke Certified



AMMO#	COLOR	PKG
CAT6E-FLUKE-B	Blue	1000/box
CAT6E-FLUKE-W	White	1000/box
CAT6E-FLUKE-GN	Green	1000/box
CAT6E-FLUKE-GY	Gray	1000/box
CAT6E-FLUKE-R	Red	1000/box
CAT6E-FLUKE-Y	Yellow	1000/box

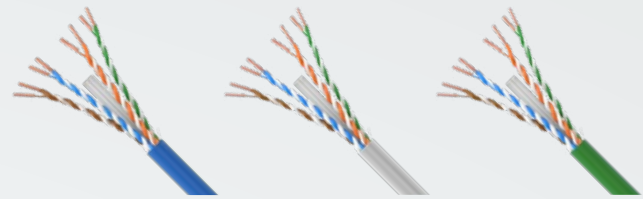

CAT6E-FLUKE-B

CAT6E-FLUKE-W

CAT6E-FLUKE-GN

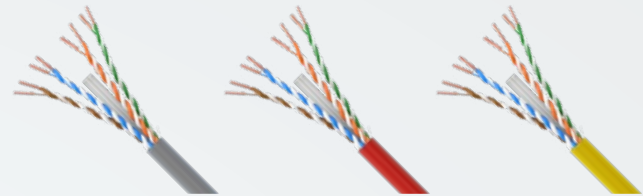

CAT6E-FLUKE-GY

CAT6E-FLUKE-R

CAT6E-FLUKE-Y

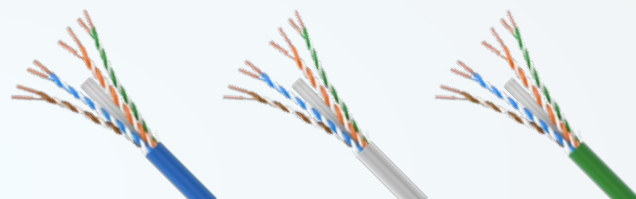

CAT6-CMP-B

CAT6-CMP-W

CAT6-CMP-GN

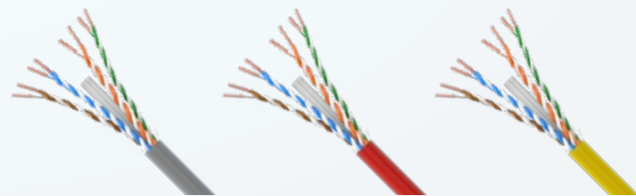

CAT6-CMP-GY

CAT6-CMP-R

CAT6-CMP-Y

CAT6 CMP Wire

Plenum-No Spline



AMMO#	COLOR	PKG
CAT6-CMP-B	Blue	1000/box
CAT6-CMP-W	White	1000/box
CAT6-CMP-GN	Green	1000/box
CAT6-CMP-GY	Gray	1000/box
CAT6-CMP-R	Red	1000/box
CAT6-CMP-Y	Yellow	1000/box

CAT6-Plenum Wire

with Spline



AMMO#	COLOR	PKG
CAT6P	23SO L/4PR plenum blue copper	1000/box

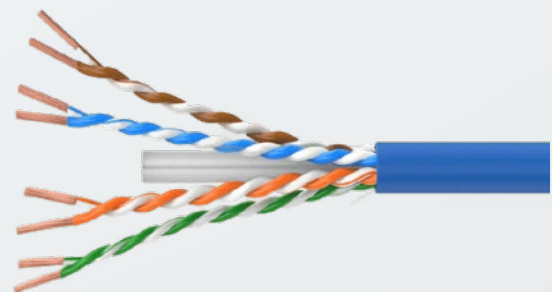

Coaxial Cable

RG6 Dual Shield Coaxial



AMMO#	COLOR	PKG
RG6-DUAL-B	Black	1000/box
RG6-DUAL-WH	White	1000/box

The ultimate choice for seamless cable and satellite signal transmission, delivering reliable performance in both residential and commercial installations.



• RG6 DUAL B



• RG6 DUAL WH

RG6 Quad Shield Coaxial



AMMO#	COLOR	PKG
RG6-QUAD-B	Black	1000/box
RG6-QUAD-WH	White	1000/box

Ensure flawless cable and satellite signal delivery for any home or commercial installation.



• RG6-QUAD-B



• RG6-QUAD-WH

THHN 14 Wire Stranded Copper



AMMO#	COLOR	LENGTH
THHN14-BE-STR-500	Blue	500 ft Reel
THHN14-BE-STR-1000	Blue	1000 ft Reel
THHN14-BE-STR-2500	Blue	2500 ft Reel
THHN14-BE-STR-5000	Blue	5000 ft Reel
THHN14-BK-STR-500	Black	500 ft Reel
THHN14-BK-STR-1000	Black	1000 ft Reel
THHN14-BK-STR-2500	Black	2500 ft Reel
THHN14-BK-STR-5000	Black	5000 ft Reel
THHN14-BR-STR-500	Brown	500 ft Reel
THHN14-BR-STR-1000	Brown	1000 ft Reel
THHN14-BR-STR-2500	Brown	2500 ft Reel
THHN14-BR-STR-5000	Brown	5000 ft Reel
THHN14-GN-STR-500	Green	500 ft Reel
THHN14-GN-STR-1000	Green	1000 ft Reel
THHN14-GN-STR-2500	Green	2500 ft Reel
THHN14-GN-STR-5000	Green	5000 ft Reel
THHN14-GRY-STR-500	Gray	500 ft Reel
THHN14-GRY-STR-1000	Gray	1000 ft Reel

AMMO#	COLOR	LENGTH
THHN14-GRY-STR-2500	Gray	2500 ft Reel
THHN14-GRY-STR-5000	Gray	5000 ft Reel
THHN14-OR-STR-500	Orange	500 ft Reel
THHN14-OR-STR-1000	Orange	1000 ft Reel
THHN14-OR-STR-2500	Orange	2500 ft Reel
THHN14-OR-STR-5000	Orange	5000 ft Reel
THHN14-RD-STR-500	Red	500 ft Reel
THHN14-RD-STR-1000	Red	1000 ft Reel
THHN14-RD-STR-2500	Red	2500 ft Reel
THHN14-RD-STR-5000	Red	5000 ft Reel
THHN14-WH-STR-500	White	500 ft Reel
THHN14-WH-STR-1000	White	1000 ft Reel
THHN14-WH-STR-2500	White	2500 ft Reel
THHN14-WH-STR-5000	White	5000 ft Reel
THHN14-YW-STR-500	Yellow	500 ft Reel
THHN14-YW-STR-1000	Yellow	1000 ft Reel
THHN14-YW-STR-2500	Yellow	2500 ft Reel
THHN14-YW-STR-5000	Yellow	5000 ft Reel

CROSS SECTIONAL AREA	NUMBER OF STRANDS	NOMINAL DIAMETER OF CONDUCTOR	INSULATION THICKNESS	NYLON JACKET THICKNESS	OVERALL DIAMETER
2.08 mm ²	19 EA	1.85 mm	0.38 mm	0.1 mm	2.81 mm

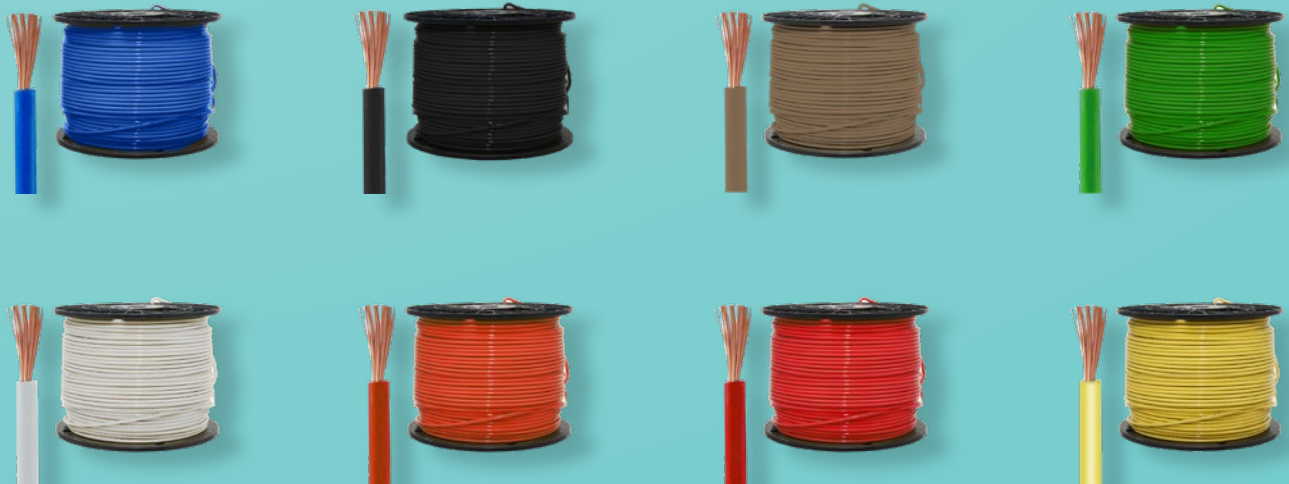



THHN 12 Wire Stranded Copper



AMMO#	COLOR	LENGTH
THHN12-BE-STR-500	Blue	500 ft Reel
THHN12-BE-STR-1000	Blue	1000 ft Reel
THHN12-BE-STR-2500	Blue	2500 ft Reel
THHN12-BE-STR-5000	Blue	5000 ft Reel
THHN12-BK-STR-500	Black	500 ft Reel
THHN12-BK-STR-1000	Black	1000 ft Reel
THHN12-BK-STR-2500	Black	2500 ft Reel
THHN12-BK-STR-5000	Black	5000 ft Reel
THHN12-BR-STR-500	Brown	500 ft Reel
THHN12-BR-STR-1000	Brown	1000 ft Reel
THHN12-BR-STR-2500	Brown	2500 ft Reel
THHN12-BR-STR-5000	Brown	5000 ft Reel
THHN12-GN-STR-500	Green	500 ft Reel
THHN12-GN-STR-1000	Green	1000 ft Reel
THHN12-GN-STR-2500	Green	2500 ft Reel
THHN12-GN-STR-5000	Green	5000 ft Reel
THHN12-OR-STR-500	Orange	500 ft Reel
THHN12-OR-STR-1000	Orange	1000 ft Reel

AMMO#	COLOR	LENGTH
THHN12-OR-STR-2500	Orange	2500 ft Reel
THHN12-OR-STR-5000	Orange	5000 ft Reel
THHN12-RD-STR-500	Red	500 ft Reel
THHN12-RD-STR-1000	Red	1000 ft Reel
THHN12-RD-STR-2500	Red	2500 ft Reel
THHN12-RD-STR-5000	Red	5000 ft Reel
THHN12-WH-STR-500	White	500 ft Reel
THHN12-WH-STR-1000	White	1000 ft Reel
THHN12-WH-STR-2500	White	2500 ft Reel
THHN12-WH-STR-5000	White	5000 ft Reel
THHN12-YW-STR-500	Yellow	500 ft Reel
THHN12-YW-STR-1000	Yellow	1000 ft Reel
THHN12-YW-STR-2500	Yellow	2500 ft Reel
THHN12-YW-STR-5000	Yellow	5000 ft Reel
THHN12-GRY-STR-500	Gray	500 ft Reel
THHN12-GRY-STR-1000	Gray	1000 ft Reel
THHN12-GRY-STR-2500	Gray	2500 ft Reel
THHN12-GRY-STR-5000	Gray	5000 ft Reel

CROSS SECTIONAL AREA	NUMBER OF STRANDS	NOMINAL DIAMETER OF CONDUCTOR	INSULATION THICKNESS	NYLON JACKET THICKNESS	OVERALL DIAMETER
3.331 mm ²	19 EA	2.32 mm	0.38 mm	0.1 mm	3.28 mm



ELECTRICAL WIRE

THHN 8 Wire Stranded Copper

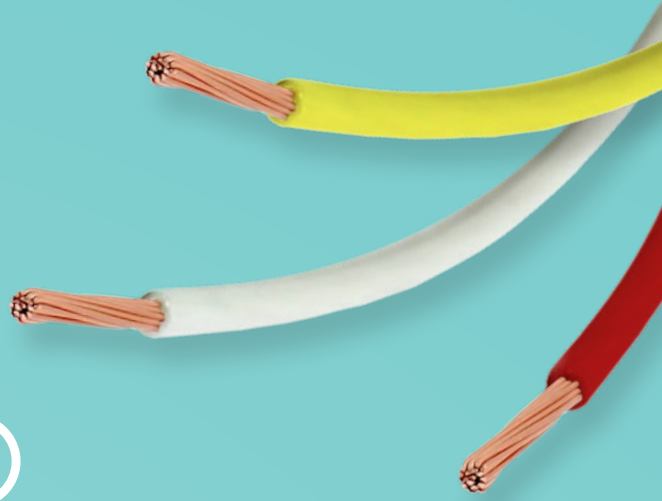

AMMO#	COLOR	LENGTH
THHN8-BE-STR-500	Blue	500 ft Reel
THHN8-BE-STR-1000	Blue	1000 ft Reel
THHN8-BE-STR-2500	Blue	2500 ft Reel
THHN8-BE-STR-5000	Blue	5000 ft Reel
THHN8-BK-STR-500	Black	500 ft Reel
THHN8-BK-STR-1000	Black	1000 ft Reel
THHN8-BK-STR-2500	Black	2500 ft Reel
THHN8-BK-STR-5000	Black	5000 ft Reel
THHN8-BR-STR-500	Brown	500 ft Reel
THHN8-BR-STR-1000	Brown	1000 ft Reel
THHN8-BR-STR-2500	Brown	2500 ft Reel
THHN8-BR-STR-5000	Brown	5000 ft Reel
THHN8-GN-STR-500	Green	500 ft Reel
THHN8-GN-STR-1000	Green	1000 ft Reel
THHN8-GN-STR-2500	Green	2500 ft Reel
THHN8-GN-STR-5000	Green	5000 ft Reel
THHN8-GRY-STR-500	Gray	500 ft Reel
THHN8-GRY-STR-1000	Gray	1000 ft Reel

AMMO#	COLOR	LENGTH
THHN8-GRY-STR-2500	Gray	2500 ft Reel
THHN8-GRY-STR-5000	Gray	5000 ft Reel
THHN8-OR-STR-500	Orange	500 ft Reel
THHN8-OR-STR-1000	Orange	1000 ft Reel
THHN8-OR-STR-2500	Orange	2500 ft Reel
THHN8-OR-STR-5000	Orange	5000 ft Reel
THHN8-RD-STR-500	Red	500 ft Reel
THHN8-RD-STR-1000	Red	1000 ft Reel
THHN8-RD-STR-2500	Red	2500 ft Reel
THHN8-RD-STR-5000	Red	5000 ft Reel
THHN8-WH-STR-500	White	500 ft Reel
THHN8-WH-STR-1000	White	1000 ft Reel
THHN8-WH-STR-2500	White	2500 ft Reel
THHN8-WH-STR-5000	White	5000 ft Reel
THHN8-YW-STR-500	Yellow	500 ft Reel
THHN8-YW-STR-1000	Yellow	1000 ft Reel
THHN8-YW-STR-2500	Yellow	2500 ft Reel
THHN8-YW-STR-5000	Yellow	5000 ft Reel

CROSS SECTIONAL AREA	NUMBER OF STRANDS	NOMINAL DIAMETER OF CONDUCTOR	INSULATION THICKNESS	NYLON JACKET THICKNESS	OVERALL DIAMETER
8.37 mm ²	19 EA	3.71 mm	0.76 mm	0.13 mm	5.49 mm



THHN 10 Wire Stranded Copper



AMMO#	COLOR	LENGTH
THHN10-BE-STR-500	Blue	500 ft Reel
THHN10-BE-STR-1000	Blue	1000 ft Reel
THHN10-BE-STR-2500	Blue	2500 ft Reel
THHN10-BE-STR-5000	Blue	5000 ft Reel
THHN10-BK-STR-500	Black	500 ft Reel
THHN10-BK-STR-1000	Black	1000 ft Reel
THHN10-BK-STR-2500	Black	2500 ft Reel
THHN10-BK-STR-5000	Black	5000 ft Reel
THHN10-BR-STR-500	Brown	500 ft Reel
THHN10-BR-STR-1000	Brown	1000 ft Reel
THHN10-BR-STR-2500	Brown	2500 ft Reel
THHN10-BR-STR-5000	Brown	5000 ft Reel
THHN10-GN-STR-500	Green	500 ft Reel
THHN10-GN-STR-1000	Green	1000 ft Reel
THHN10-GN-STR-2500	Green	2500 ft Reel
THHN10-GN-STR-5000	Green	5000 ft Reel
THHN10-OR-STR-500	Orange	500 ft Reel
THHN10-OR-STR-1000	Orange	1000 ft Reel

AMMO#	COLOR	LENGTH
THHN10-OR-STR-2500	Orange	2500 ft Reel
THHN10-OR-STR-5000	Orange	5000 ft Reel
THHN10-RD-STR-500	Red	500 ft Reel
THHN10-RD-STR-1000	Red	1000 ft Reel
THHN10-RD-STR-2500	Red	2500 ft Reel
THHN10-RD-STR-5000	Red	5000 ft Reel
THHN10-WH-STR-500	White	500 ft Reel
THHN10-WH-STR-1000	White	1000 ft Reel
THHN10-WH-STR-2500	White	2500 ft Reel
THHN10-WH-STR-5000	White	5000 ft Reel
THHN10-YW-STR-500	Yellow	500 ft Reel
THHN10-YW-STR-1000	Yellow	1000 ft Reel
THHN10-YW-STR-2500	Yellow	2500 ft Reel
THHN10-YW-STR-5000	Yellow	5000 ft Reel
THHN10-GRY-STR-500	Gray	500 ft Reel
THHN10-GRY-STR-1000	Gray	1000 ft Reel
THHN10-GRY-STR-2500	Gray	2500 ft Reel
THHN10-GRY-STR-5000	Gray	5000 ft Reel

CROSS SECTIONAL AREA	NUMBER OF STRANDS	NOMINAL DIAMETER OF CONDUCTOR	INSULATION THICKNESS	NYLON JACKET THICKNESS	OVERALL DIAMETER
5.26 mm ²	19 EA	2.95 mm	0.51 mm	0.1 mm	4.17 mm

ELECTRICAL WIRE

THHN 6 Wire Stranded Copper



AMMO#	COLOR	LENGTH
THHN6-BE-STR-500	Blue	500 ft Reel
THHN6-BE-STR-1000	Blue	1000 ft Reel
THHN6-BE-STR-2500	Blue	2500 ft Reel
THHN6-BE-STR-5000	Blue	5000 ft Reel
THHN6-BK-STR-500	Black	500 ft Reel
THHN6-BK-STR-1000	Black	1000 ft Reel
THHN6-BK-STR-2500	Black	2500 ft Reel
THHN6-BK-STR-5000	Black	5000 ft Reel
THHN6-BR-STR-500	Brown	500 ft Reel
THHN6-BR-STR-1000	Brown	1000 ft Reel
THHN6-BR-STR-2500	Brown	2500 ft Reel
THHN6-BR-STR-5000	Brown	5000 ft Reel
THHN6-GN-STR-500	Green	500 ft Reel
THHN6-GN-STR-1000	Green	1000 ft Reel
THHN6-GN-STR-2500	Green	2500 ft Reel
THHN6-GN-STR-5000	Green	5000 ft Reel

AMMO#	COLOR	LENGTH
THHN6-OR-STR-500	Orange	500 ft Reel
THHN6-OR-STR-1000	Orange	1000 ft Reel
THHN6-OR-STR-2500	Orange	2500 ft Reel
THHN6-OR-STR-5000	Orange	5000 ft Reel
THHN6-RD-STR-500	Red	500 ft Reel
THHN6-RD-STR-1000	Red	1000 ft Reel
THHN6-RD-STR-2500	Red	2500 ft Reel
THHN6-RD-STR-5000	Red	5000 ft Reel
THHN6-WH-STR-500	White	500 ft Reel
THHN6-WH-STR-1000	White	1000 ft Reel
THHN6-WH-STR-2500	White	2500 ft Reel
THHN6-WH-STR-5000	White	5000 ft Reel
THHN6-YW-STR-500	Yellow	500 ft Reel
THHN6-YW-STR-1000	Yellow	1000 ft Reel
THHN6-YW-STR-2500	Yellow	2500 ft Reel
THHN6-YW-STR-5000	Yellow	5000 ft Reel

CROSS SECTIONAL AREA	NUMBER OF STRANDS	NOMINAL DIAMETER OF CONDUCTOR	INSULATION THICKNESS	NYLON JACKET THICKNESS	OVERALL DIAMETER
13.3 mm ²	19 EA	4.67 mm	0.76 mm	0.13 mm	6.45 mm



THHN 4 Wire Stranded Copper



AMMO#	COLOR	LENGTH
THHN4-BE-STR-500	Blue	500 ft Reel
THHN4-BE-STR-1000	Blue	1000 ft Reel
THHN4-BE-STR-2500	Blue	2500 ft Reel
THHN4-BE-STR-5000	Blue	5000 ft Reel
THHN4-BK-STR-500	Black	500 ft Reel
THHN4-BK-STR-1000	Black	1000 ft Reel
THHN4-BK-STR-2500	Black	2500 ft Reel
THHN4-BK-STR-5000	Black	5000 ft Reel
THHN4-BR-STR-500	Brown	500 ft Reel
THHN4-BR-STR-1000	Brown	1000 ft Reel
THHN4-BR-STR-2500	Brown	2500 ft Reel
THHN4-BR-STR-5000	Brown	5000 ft Reel
THHN4-GN-STR-500	Green	500 ft Reel
THHN4-GN-STR-1000	Green	1000 ft Reel
THHN4-GN-STR-2500	Green	2500 ft Reel
THHN4-GN-STR-5000	Green	5000 ft Reel

AMMO#	COLOR	LENGTH
THHN4-OR-STR-500	Orange	500 ft Reel
THHN4-OR-STR-1000	Orange	1000 ft Reel
THHN4-OR-STR-2500	Orange	2500 ft Reel
THHN4-OR-STR-5000	Orange	5000 ft Reel
THHN4-RD-STR-500	Red	500 ft Reel
THHN4-RD-STR-1000	Red	1000 ft Reel
THHN4-RD-STR-2500	Red	2500 ft Reel
THHN4-RD-STR-5000	Red	5000 ft Reel
THHN4-WH-STR-500	White	500 ft Reel
THHN4-WH-STR-1000	White	1000 ft Reel
THHN4-WH-STR-2500	White	2500 ft Reel
THHN4-WH-STR-5000	White	5000 ft Reel
THHN4-YW-STR-500	Yellow	500 ft Reel
THHN4-YW-STR-1000	Yellow	1000 ft Reel
THHN4-YW-STR-2500	Yellow	2500 ft Reel
THHN4-YW-STR-5000	Yellow	5000 ft Reel

CROSS SECTIONAL AREA	NUMBER OF STRANDS	NOMINAL DIAMETER OF CONDUCTOR	INSULATION THICKNESS	NYLON JACKET THICKNESS	OVERALL DIAMETER
21.2 mm ²	19 EA	5.89 mm	1.02 mm	0.15 mm	8.23 mm



THHN 3 Wire Stranded Copper



AMMO#	COLOR	LENGTH
THHN3-BE-STR-1000	Blue	1000 ft Reel
THHN3-BE-STR-2500	Blue	2500 ft Reel
THHN3-BK-STR-1000	Black	1000 ft Reel
THHN3-BK-STR-2500	Black	2500 ft Reel
THHN3-BR-STR-1000	Brown	1000 ft Reel
THHN3-BR-STR-2500	Brown	2500 ft Reel
THHN3-GN-STR-1000	Green	1000 ft Reel
THHN3-GN-STR-2500	Green	2500 ft Reel
THHN3-OR-STR-1000	Orange	1000 ft Reel
THHN3-OR-STR-2500	Orange	2500 ft Reel
THHN3-RD-STR-1000	Red	1000 ft Reel
THHN3-RD-STR-2500	Red	2500 ft Reel
THHN3-WH-STR-1000	White	1000 ft Reel
THHN3-WH-STR-2500	White	2500 ft Reel
THHN3-YW-STR-1000	Yellow	1000 ft Reel
THHN3-YW-STR-2500	Yellow	2500 ft Reel

CROSS SECTIONAL AREA	NUMBER OF STRANDS	NOMINAL DIAMETER OF CONDUCTOR
26.7 mm ²	19 EA	6.6 mm

INSULATION THICKNESS	NYLON JACKET THICKNESS	OVERALL DIAMETER
1.02 mm	0.15 mm	8.94 mm

THHN 2 Wire Stranded Copper



AMMO#	COLOR	LENGTH
THHN2-BE-STR-1000	Blue	1000 ft Reel
THHN2-BE-STR-2500	Blue	2500 ft Reel
THHN2-BK-STR-1000	Black	1000 ft Reel
THHN2-BK-STR-2500	Black	2500 ft Reel
THHN2-BR-STR-1000	Brown	1000 ft Reel
THHN2-BR-STR-2500	Brown	2500 ft Reel
THHN2-GN-STR-1000	Green	1000 ft Reel
THHN2-GN-STR-2500	Green	2500 ft Reel
THHN2-OR-STR-1000	Orange	1000 ft Reel
THHN2-OR-STR-2500	Orange	2500 ft Reel
THHN2-RD-STR-1000	Red	1000 ft Reel
THHN2-RD-STR-2500	Red	2500 ft Reel
THHN2-WH-STR-1000	White	1000 ft Reel
THHN2-WH-STR-2500	White	2500 ft Reel
THHN2-YW-STR-1000	Yellow	1000 ft Reel
THHN2-YW-STR-2500	Yellow	2500 ft Reel

CROSS SECTIONAL AREA	NUMBER OF STRANDS	NOMINAL DIAMETER OF CONDUCTOR
33.6 mm ²	19 EA	7.42 mm

INSULATION THICKNESS	NYLON JACKET THICKNESS	OVERALL DIAMETER
1.02 mm	0.15 mm	9.76 mm





THHN 1 Wire Stranded Copper



AMMO#	COLOR	LENGTH
THHN1-BE-STR-1000	Blue	1000 ft Reel
THHN1-BE-STR-2500	Blue	2500 ft Reel
THHN1-BK-STR-1000	Black	1000 ft Reel
THHN1-BK-STR-2500	Black	2500 ft Reel
THHN1-BR-STR-1000	Brown	1000 ft Reel
THHN1-BR-STR-2500	Brown	2500 ft Reel
THHN1-GN-STR-1000	Green	1000 ft Reel
THHN1-GN-STR-2500	Green	2500 ft Reel
THHN1-OR-STR-1000	Orange	1000 ft Reel
THHN1-OR-STR-2500	Orange	2500 ft Reel
THHN1-RD-STR-1000	Red	1000 ft Reel
THHN1-RD-STR-2500	Red	2500 ft Reel
THHN1-WH-STR-1000	White	1000 ft Reel
THHN1-WH-STR-2500	White	2500 ft Reel
THHN1-YW-STR-1000	Yellow	1000 ft Reel
THHN1-YW-STR-2500	Yellow	2500 ft Reel

CROSS SECTIONAL AREA	NUMBER OF STRANDS	NOMINAL DIAMETER OF CONDUCTOR
42.4 mm ²	19 EA	8.43 mm

INSULATION THICKNESS	NYLON JACKET THICKNESS	OVERALL DIAMETER
1.27 mm	0.18 mm	11.33 mm

THHN 1/0 Wire Stranded Copper



AMMO#	COLOR	LENGTH
THHN1/0-BE-STR-1000	Blue	1000 ft Reel
THHN1/0-BE-STR-2500	Blue	2500 ft Reel
THHN1/0-BK-STR-1000	Black	1000 ft Reel
THHN1/0-BK-STR-2500	Black	2500 ft Reel
THHN1/0-BR-STR-1000	Brown	1000 ft Reel
THHN1/0-BR-STR-2500	Brown	2500 ft Reel
THHN1/0-GN-STR-1000	Green	1000 ft Reel
THHN1/0-GN-STR-2500	Green	2500 ft Reel
THHN1/0-OR-STR-1000	Orange	1000 ft Reel
THHN1/0-OR-STR-2500	Orange	2500 ft Reel
THHN1/0-RD-STR-1000	Red	1000 ft Reel
THHN1/0-RD-STR-2500	Red	2500 ft Reel
THHN1/0-WH-STR-1000	White	1000 ft Reel
THHN1/0-WH-STR-2500	White	2500 ft Reel
THHN1/0-YW-STR-1000	Yellow	1000 ft Reel
THHN1/0-YW-STR-2500	Yellow	2500 ft Reel

CROSS SECTIONAL AREA	NUMBER OF STRANDS	NOMINAL DIAMETER OF CONDUCTOR
53.5 mm ²	19 EA	9.45 mm

INSULATION THICKNESS	NYLON JACKET THICKNESS	OVERALL DIAMETER
1.27 mm	0.18 mm	12.35 mm

ELECTRICAL WIRE



THHN 3/0 Wire Stranded Copper



AMMO#	COLOR	LENGTH
THHN3/0-BE-STR-1000	Blue	1000 ft Reel
THHN3/0-BE-STR-2500	Blue	2500 ft Reel
THHN3/0-BK-STR-1000	Black	1000 ft Reel
THHN3/0-BK-STR-2500	Black	2500 ft Reel
THHN3/0-BR-STR-1000	Brown	1000 ft Reel
THHN3/0-BR-STR-2500	Brown	2500 ft Reel
THHN3/0-GN-STR-1000	Green	1000 ft Reel
THHN3/0-GN-STR-2500	Green	2500 ft Reel
THHN3/0-OR-STR-1000	Orange	1000 ft Reel
THHN3/0-OR-STR-2500	Orange	2500 ft Reel
THHN3/0-RD-STR-1000	Red	1000 ft Reel
THHN3/0-RD-STR-2500	Red	2500 ft Reel
THHN3/0-WH-STR-1000	White	1000 ft Reel
THHN3/0-WH-STR-2500	White	2500 ft Reel
THHN3/0-YW-STR-1000	Yellow	1000 ft Reel
THHN3/0-YW-STR-2500	Yellow	2500 ft Reel

THHN 2/0 Wire Stranded Copper



AMMO#	COLOR	LENGTH
THHN2/0-BE-STR-1000	Blue	1000 ft Reel
THHN2/0-BE-STR-2500	Blue	2500 ft Reel
THHN2/0-BK-STR-1000	Black	1000 ft Reel
THHN2/0-BK-STR-2500	Black	2500 ft Reel
THHN2/0-BR-STR-1000	Brown	1000 ft Reel
THHN2/0-BR-STR-2500	Brown	2500 ft Reel
THHN2/0-GN-STR-1000	Green	1000 ft Reel
THHN2/0-GN-STR-2500	Green	2500 ft Reel
THHN2/0-OR-STR-1000	Orange	1000 ft Reel
THHN2/0-OR-STR-2500	Orange	2500 ft Reel
THHN2/0-RD-STR-1000	Red	1000 ft Reel
THHN2/0-RD-STR-2500	Red	2500 ft Reel
THHN2/0-WH-STR-1000	White	1000 ft Reel
THHN2/0-WH-STR-2500	White	2500 ft Reel
THHN2/0-YW-STR-1000	Yellow	1000 ft Reel
THHN2/0-YW-STR-2500	Yellow	2500 ft Reel

CROSS SECTIONAL AREA	NUMBER OF STRANDS	NOMINAL DIAMETER OF CONDUCTOR
42.4 mm ²	19 EA	8.43 mm

INSULATION THICKNESS	NYLON JACKET THICKNESS	OVERALL DIAMETER
1.27 mm	0.18 mm	11.33 mm

CROSS SECTIONAL AREA	NUMBER OF STRANDS	NOMINAL DIAMETER OF CONDUCTOR
53.5 mm ²	19 EA	9.45 mm

INSULATION THICKNESS	NYLON JACKET THICKNESS	OVERALL DIAMETER
1.27 mm	0.18 mm	12.35 mm





THHN 4/0 Wire Stranded Copper



AMMO#	COLOR	LENGTH
THHN4/0-BE-STR-1000	Blue	1000 ft Reel
THHN4/0-BE-STR-2500	Blue	2500 ft Reel
THHN4/0-BK-STR-1000	Black	1000 ft Reel
THHN4/0-BK-STR-2500	Black	2500 ft Reel
THHN4/0-BR-STR-1000	Brown	1000 ft Reel
THHN4/0-BR-STR-2500	Brown	2500 ft Reel
THHN4/0-GN-STR-1000	Green	1000 ft Reel
THHN4/0-GN-STR-2500	Green	2500 ft Reel
THHN4/0-OR-STR-1000	Orange	1000 ft Reel
THHN4/0-OR-STR-2500	Orange	2500 ft Reel
THHN4/0-RD-STR-1000	Red	1000 ft Reel
THHN4/0-RD-STR-2500	Red	2500 ft Reel
THHN4/0-WH-STR-1000	White	1000 ft Reel
THHN4/0-WH-STR-2500	White	2500 ft Reel
THHN4/0-YW-STR-1000	Yellow	1000 ft Reel
THHN4/0-YW-STR-2500	Yellow	2500 ft Reel

THHN 250 Wire Stranded Copper



AMMO#	COLOR	LENGTH
THHN250-BE-STR-1000	Blue	1000 ft Reel
THHN250-BE-STR-2500	Blue	2500 ft Reel
THHN250-BK-STR-1000	Black	1000 ft Reel
THHN250-BK-STR-2500	Black	2500 ft Reel
THHN250-BR-STR-1000	Brown	1000 ft Reel
THHN250-BR-STR-2500	Brown	2500 ft Reel
THHN250-GN-STR-1000	Green	1000 ft Reel
THHN250-GN-STR-2500	Green	2500 ft Reel
THHN250-OR-STR-1000	Orange	1000 ft Reel
THHN250-OR-STR-2500	Orange	2500 ft Reel
THHN250-RD-STR-1000	Red	1000 ft Reel
THHN250-RD-STR-2500	Red	2500 ft Reel
THHN250-WH-STR-1000	White	1000 ft Reel
THHN250-WH-STR-2500	White	2500 ft Reel
THHN250-YW-STR-1000	Yellow	1000 ft Reel
THHN250-YW-STR-2500	Yellow	2500 ft Reel

CROSS SECTIONAL AREA	NUMBER OF STRANDS	NOMINAL DIAMETER OF CONDUCTOR
107 mm ²	19 EA	13.41 mm

INSULATION THICKNESS	NYLON JACKET THICKNESS	OVERALL DIAMETER
1.27 mm	0.18 mm	16.31 mm

CROSS SECTIONAL AREA	NUMBER OF STRANDS	NOMINAL DIAMETER OF CONDUCTOR
127 mm ²	19 EA	14.6 mm

INSULATION THICKNESS	NYLON JACKET THICKNESS	OVERALL DIAMETER
1.52 mm	0.2 mm	18.04 mm

ELECTRICAL WIRE



THHN 350 Wire Stranded Copper



THHN 300 Wire Stranded Copper



AMMO#	COLOR	LENGTH
THHN300-BE-STR-1000	Blue	1000 ft Reel
THHN300-BE-STR-2500	Blue	2500 ft Reel
THHN300-BK-STR-1000	Black	1000 ft Reel
THHN300-BK-STR-2500	Black	2500 ft Reel
THHN300-BR-STR-1000	Brown	1000 ft Reel
THHN300-BR-STR-2500	Brown	2500 ft Reel
THHN300-GN-STR-1000	Green	1000 ft Reel
THHN300-GN-STR-2500	Green	2500 ft Reel
THHN300-OR-STR-1000	Orange	1000 ft Reel
THHN300-OR-STR-2500	Orange	2500 ft Reel
THHN300-RD-STR-1000	Red	1000 ft Reel
THHN300-RD-STR-2500	Red	2500 ft Reel
THHN300-WH-STR-1000	White	1000 ft Reel
THHN300-WH-STR-2500	White	2500 ft Reel
THHN300-YW-STR-1000	Yellow	1000 ft Reel
THHN300-YW-STR-2500	Yellow	2500 ft Reel

AMMO#	COLOR	LENGTH
THHN350-BE-STR-1000	Blue	1000 ft Reel
THHN350-BE-STR-2500	Blue	2500 ft Reel
THHN350-BK-STR-1000	Black	1000 ft Reel
THHN350-BK-STR-2500	Black	2500 ft Reel
THHN350-BR-STR-1000	Brown	1000 ft Reel
THHN350-BR-STR-2500	Brown	2500 ft Reel
THHN350-GN-STR-1000	Green	1000 ft Reel
THHN350-GN-STR-2500	Green	2500 ft Reel
THHN350-OR-STR-1000	Orange	1000 ft Reel
THHN350-OR-STR-2500	Orange	2500 ft Reel
THHN350-RD-STR-1000	Red	1000 ft Reel
THHN350-RD-STR-2500	Red	2500 ft Reel
THHN350-WH-STR-1000	White	1000 ft Reel
THHN350-WH-STR-2500	White	2500 ft Reel
THHN350-YW-STR-1000	Yellow	1000 ft Reel
THHN350-YW-STR-2500	Yellow	2500 ft Reel

CROSS SECTIONAL AREA	NUMBER OF STRANDS	NOMINAL DIAMETER OF CONDUCTOR
177 mm ²	19 EA	17.3 mm

INSULATION THICKNESS	NYLON JACKET THICKNESS	OVERALL DIAMETER
1.52 mm	0.2 mm	20.74 mm

CROSS SECTIONAL AREA	NUMBER OF STRANDS	NOMINAL DIAMETER OF CONDUCTOR
152 mm ²	19 EA	16 mm

INSULATION THICKNESS	NYLON JACKET THICKNESS	OVERALL DIAMETER
1.52 mm	0.2 mm	19.44 mm

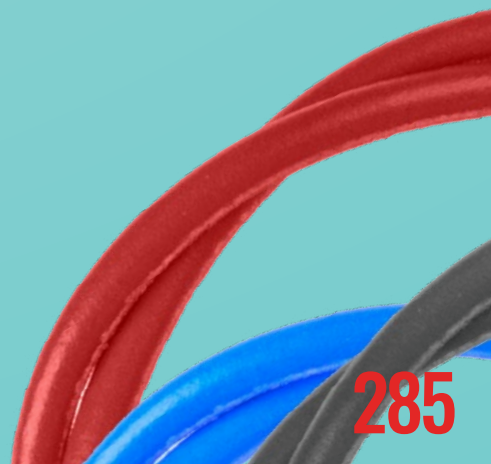



THHN 400 Wire Stranded Copper



AMMO#	COLOR	LENGTH
THHN400-BE-STR-1000	Blue	1000 ft Reel
THHN400-BE-STR-2500	Blue	2500 ft Reel
THHN400-BK-STR-1000	Black	1000 ft Reel
THHN400-BK-STR-2500	Black	2500 ft Reel
THHN400-BR-STR-1000	Brown	1000 ft Reel
THHN400-BR-STR-2500	Brown	2500 ft Reel
THHN400-GN-STR-1000	Green	1000 ft Reel
THHN400-GN-STR-2500	Green	2500 ft Reel
THHN400-OR-STR-1000	Orange	1000 ft Reel
THHN400-OR-STR-2500	Orange	2500 ft Reel
THHN400-RD-STR-1000	Red	1000 ft Reel
THHN400-RD-STR-2500	Red	2500 ft Reel
THHN400-WH-STR-1000	White	1000 ft Reel
THHN400-WH-STR-2500	White	2500 ft Reel
THHN400-YW-STR-1000	Yellow	1000 ft Reel
THHN400-YW-STR-2500	Yellow	2500 ft Reel

THHN 500 Wire Stranded Copper



AMMO#	COLOR	LENGTH
THHN500-BE-STR-1000	Blue	1000 ft Reel
THHN500-BE-STR-2500	Blue	2500 ft Reel
THHN500-BK-STR-1000	Black	1000 ft Reel
THHN500-BK-STR-2500	Black	2500 ft Reel
THHN500-BR-STR-1000	Brown	1000 ft Reel
THHN500-BR-STR-2500	Brown	2500 ft Reel
THHN500-GN-STR-1000	Green	1000 ft Reel
THHN500-GN-STR-2500	Green	2500 ft Reel
THHN500-OR-STR-1000	Orange	1000 ft Reel
THHN500-OR-STR-2500	Orange	2500 ft Reel
THHN500-RD-STR-1000	Red	1000 ft Reel
THHN500-RD-STR-2500	Red	2500 ft Reel
THHN500-WH-STR-1000	White	1000 ft Reel
THHN500-WH-STR-2500	White	2500 ft Reel
THHN500-YW-STR-1000	Yellow	1000 ft Reel
THHN500-YW-STR-2500	Yellow	2500 ft Reel

CROSS SECTIONAL AREA	NUMBER OF STRANDS	NOMINAL DIAMETER OF CONDUCTOR
203 mm ²	19 EA	18.49 mm

INSULATION THICKNESS	NYLON JACKET THICKNESS	OVERALL DIAMETER
1.52 mm	0.2 mm	21.93 mm

CROSS SECTIONAL AREA	NUMBER OF STRANDS	NOMINAL DIAMETER OF CONDUCTOR
253 mm ²	19 EA	20.65 mm

INSULATION THICKNESS	NYLON JACKET THICKNESS	OVERALL DIAMETER
1.52 mm	0.2 mm	24.09 mm



ELECTRICAL WIRE

THHN 14 Wire Solid



AMMO#	COLOR	LENGTH
THHN14-BE-SOL-1000	Blue	1000 ft Reel
THHN14-BE-SOL-500	Blue	500 ft Reel
THHN14-BK-SOL-1000	Black	1000 ft Reel
THHN14-BK-SOL-500	Black	500 ft Reel
THHN14-BR-SOL-1000	Brown	1000 ft Reel
THHN14-BR-SOL-500	Brown	500 ft Reel
THHN14-GN-SOL-1000	Green	1000 ft Reel
THHN14-GN-SOL-500	Green	500 ft Reel
THHN14-OR-SOL-1000	Orange	1000 ft Reel
THHN14-OR-SOL-500	Orange	500 ft Reel
THHN14-RD-SOL-1000	Red	1000 ft Reel
THHN14-RD-SOL-500	Red	500 ft Reel
THHN14-WH-SOL-1000	White	1000 ft Reel
THHN14-WH-SOL-500	White	500 ft Reel
THHN14-YW-SOL-1000	Yellow	1000 ft Reel
THHN14-YW-SOL-500	Yellow	500 ft Reel

CROSS SECTIONAL AREA	NUMBER OF STRANDS	NOMINAL DIAMETER OF CONDUCTOR	INSULATION THICKNESS	NYLON JACKET THICKNESS	OVERALL DIAMETER
2.08 mm ²	1 EA	1.63 mm	0.38 mm	0.1 mm	2.59 mm



THHN 12

Wire Solid



AMMO#	COLOR	LENGTH
THHN12-BE-SOL-1000	Blue	1000 ft Reel
THHN12-BE-SOL-500	Blue	500 ft Reel
THHN12-BK-SOL-1000	Black	1000 ft Reel
THHN12-BK-SOL-500	Black	500 ft Reel
THHN12-BR-SOL-1000	Brown	1000 ft Reel
THHN12-BR-SOL-500	Brown	500 ft Reel
THHN12-GN-SOL-1000	Green	1000 ft Reel
THHN12-GN-SOL-500	Green	500 ft Reel
THHN12-OR-SOL-1000	Orange	1000 ft Reel
THHN12-OR-SOL-500	Orange	500 ft Reel
THHN12-RD-SOL-1000	Red	1000 ft Reel
THHN12-RD-SOL-500	Red	500 ft Reel
THHN12-WH-SOL-1000	White	1000 ft Reel
THHN12-WH-SOL-500	White	500 ft Reel
THHN12-YW-SOL-1000	Yellow	1000 ft Reel
THHN12-YW-SOL-500	Yellow	500 ft Reel

CROSS SECTIONAL AREA	NUMBER OF STRANDS	NOMINAL DIAMETER OF CONDUCTOR
3.31 mm ²	1 EA	2.05 mm

INSULATION THICKNESS	NYLON JACKET THICKNESS	OVERALL DIAMETER
0.38 mm	0.1 mm	3.81 mm

THHN 10

Wire Solid



AMMO#	COLOR	LENGTH
THHN10-BE-SOL-1000	Blue	1000 ft Reel
THHN10-BE-SOL-500	Blue	500 ft Reel
THHN10-BK-SOL-1000	Black	1000 ft Reel
THHN10-BK-SOL-500	Black	500 ft Reel
THHN10-BR-SOL-1000	Brown	1000 ft Reel
THHN10-BR-SOL-500	Brown	500 ft Reel
THHN10-GN-SOL-1000	Green	1000 ft Reel
THHN10-GN-SOL-500	Green	500 ft Reel
THHN10-OR-SOL-1000	Orange	1000 ft Reel
THHN10-OR-SOL-500	Orange	500 ft Reel
THHN10-RD-SOL-1000	Red	1000 ft Reel
THHN10-RD-SOL-500	Red	500 ft Reel
THHN10-WH-SOL-1000	White	1000 ft Reel
THHN10-WH-SOL-500	White	500 ft Reel
THHN10-YW-SOL-1000	Yellow	1000 ft Reel
THHN10-YW-SOL-500	Yellow	500 ft Reel

CROSS SECTIONAL AREA	NUMBER OF STRANDS	NOMINAL DIAMETER OF CONDUCTOR
5.26 mm ²	1 EA	2.59 mm

INSULATION THICKNESS	NYLON JACKET THICKNESS	OVERALL DIAMETER
0.51 mm	0.1 mm	3.81 mm

THHN 8

Wire
Solid



AMMO#	COLOR	LENGTH
THHN8-BE-SOL-1000	Blue	1000 ft Reel
THHN8-BE-SOL-500	Blue	500 ft Reel
THHN8-BK-SOL-1000	Black	1000 ft Reel
THHN8-BK-SOL-500	Black	500 ft Reel
THHN8-BR-SOL-1000	Brown	1000 ft Reel
THHN8-BR-SOL-500	Brown	500 ft Reel
THHN8-GN-SOL-1000	Green	1000 ft Reel
THHN8-GN-SOL-500	Green	500 ft Reel
THHN8-OR-SOL-1000	Orange	1000 ft Reel
THHN8-OR-SOL-500	Orange	500 ft Reel
THHN8-RD-SOL-1000	Red	1000 ft Reel
THHN8-RD-SOL-500	Red	500 ft Reel
THHN8-WH-SOL-1000	White	1000 ft Reel
THHN8-WH-SOL-500	White	500 ft Reel
THHN8-YW-SOL-1000	Yellow	1000 ft Reel
THHN8-YW-SOL-500	Yellow	500 ft Reel

CROSS SECTIONAL AREA	NUMBER OF STRANDS	NOMINAL DIAMETER OF CONDUCTOR	INSULATION THICKNESS	NYLON JACKET THICKNESS	OVERALL DIAMETER
8.37 mm ²	1 EA	3.71 mm	0.76 mm	0.13 mm	5.49 mm

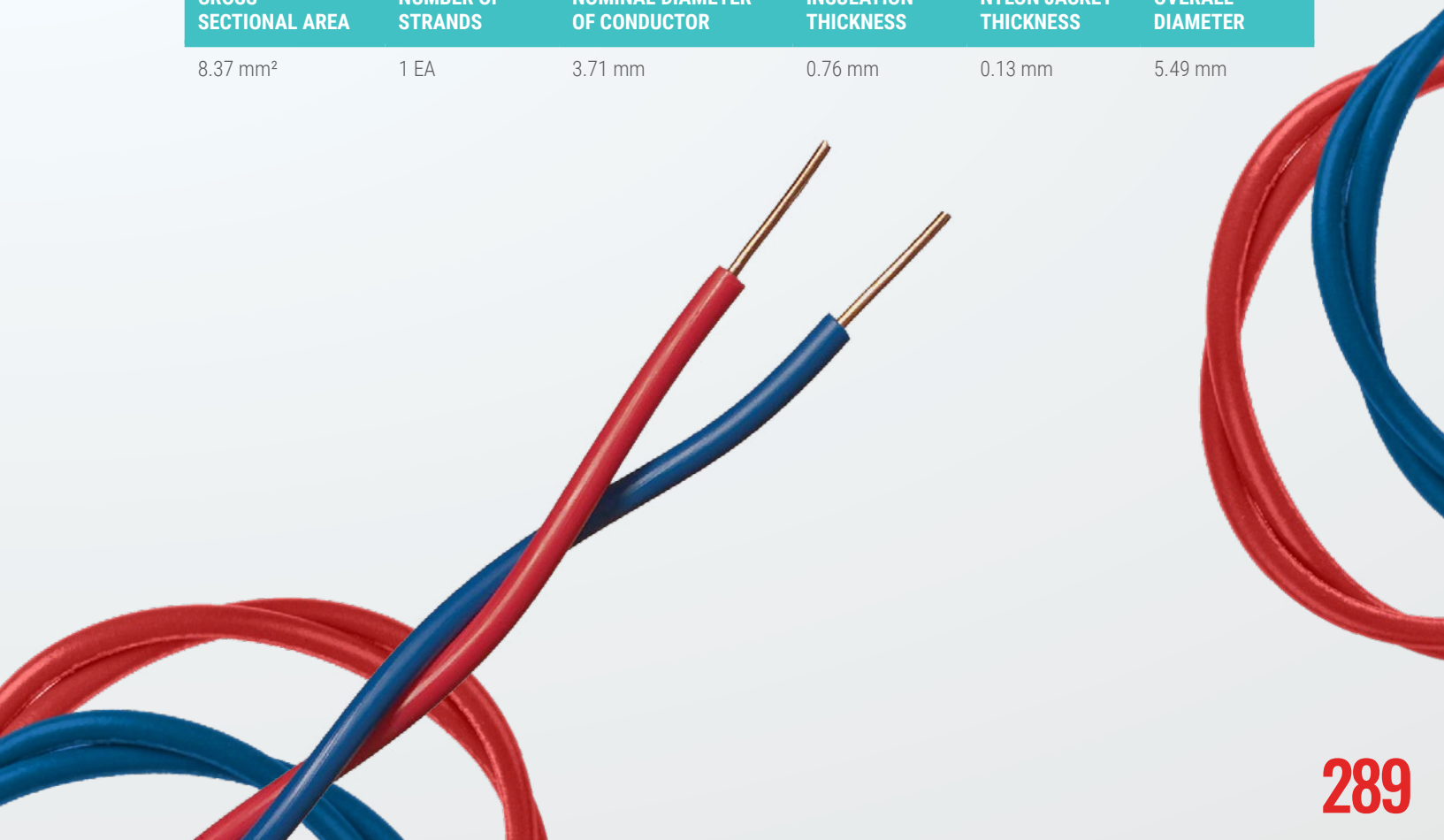



THHN 6

Wire Solid



AMMO#	COLOR	LENGTH
THHN6-BE-SOL-1000	Blue	1000 ft Reel
THHN6-BE-SOL-500	Blue	500 ft Reel
THHN6-BK-SOL-1000	Black	1000 ft Reel
THHN6-BK-SOL-500	Black	500 ft Reel
THHN6-BR-SOL-1000	Brown	1000 ft Reel
THHN6-BR-SOL-500	Brown	500 ft Reel
THHN6-GN-SOL-1000	Green	1000 ft Reel
THHN6-GN-SOL-500	Green	500 ft Reel
THHN6-OR-SOL-1000	Orange	1000 ft Reel
THHN6-OR-SOL-500	Orange	500 ft Reel
THHN6-RD-SOL-1000	Red	1000 ft Reel
THHN6-RD-SOL-500	Red	500 ft Reel
THHN6-WH-SOL-1000	White	1000 ft Reel
THHN6-WH-SOL-500	White	500 ft Reel
THHN6-YW-SOL-1000	Yellow	1000 ft Reel
THHN6-YW-SOL-500	Yellow	500 ft Reel

CROSS SECTIONAL AREA	NUMBER OF STRANDS	NOMINAL DIAMETER OF CONDUCTOR	INSULATION THICKNESS	NYLON JACKET THICKNESS	OVERALL DIAMETER
13.3 mm ²	1 EA	4.67 mm	0.76 mm	0.13 mm	6.45 mm

ELECTRICAL WIRE

290

+718.338.1851

info@ammoelectric.com

www.ammoelectric.com

THHN 4

Wire
Solid



AMMO#	COLOR	LENGTH
THHN4-BE-SOL-1000	Blue	1000 ft Reel
THHN4-BK-SOL-1000	Black	1000 ft Reel
THHN4-BR-SOL-1000	Brown	1000 ft Reel
THHN4-GN-SOL-1000	Green	1000 ft Reel
THHN4-OR-SOL-1000	Orange	1000 ft Reel
THHN4-RD-SOL-1000	Red	1000 ft Reel
THHN4-YW-SOL-1000	Yellow	1000 ft Reel
THHN4-WH-SOL-1000	White	1000 ft Reel

CROSS SECTIONAL AREA	NUMBER OF STRANDS	NOMINAL DIAMETER OF CONDUCTOR	INSULATION THICKNESS	NYLON JACKET THICKNESS	OVERALL DIAMETER
21.2 mm ²	1 EA	5.89 mm	1.02 mm	0.15 mm	8.23 mm





XHHW2

Aluminum Wire



AMMO#	LENGTH
8-XHHW2-RL-500	500 ft Reel
6-XHHW2-RL-500	500 ft Reel
4-XHHW2-RL-500	500 ft Reel
3-XHHW2-RL-500	500 ft Reel
2-XHHW2-RL-500	500 ft Reel
1-XHHW2-RL-500	500 ft Reel
1/0-XHHW2-RL-500	500 ft Reel
2/0-XHHW2-RL-500	500 ft Reel
3/0-XHHW2-RL-500	500 ft Reel
4/0-XHHW2-RL-500	500 ft Reel
250-XHHW2-RL-500	500 ft Reel

AMMO#	LENGTH
8-XHHW2-RL-5000	5,000 ft Reel
6-XHHW2-RL-5000	5,000 ft Reel
4-XHHW2-RL-5000	5,000 ft Reel
3-XHHW2-RL-5000	5,000 ft Reel
2-XHHW2-RL-5000	5,000 ft Reel
1-XHHW2-RL-5000	5,000 ft Reel
1/0-XHHW2-RL-5000	5,000 ft Reel
2/0-XHHW2-RL-5000	5,000 ft Reel
3/0-XHHW2-RL-5000	5,000 ft Reel
4/0-XHHW2-RL-5000	5,000 ft Reel
250-XHHW2-RL-5000	5,000 ft Reel

AMMO#	LENGTH
8-XHHW2-RL-1000	1,000 ft Reel
6-XHHW2-RL-1000	1,000 ft Reel
4-XHHW2-RL-1000	1,000 ft Reel
3-XHHW2-RL-1000	1,000 ft Reel
2-XHHW2-RL-1000	1,000 ft Reel
1-XHHW2-RL-1000	1,000 ft Reel
1/0-XHHW2-RL-1000	1,000 ft Reel
2/0-XHHW2-RL-1000	1,000 ft Reel
3/0-XHHW2-RL-1000	1,000 ft Reel
4/0-XHHW2-RL-1000	1,000 ft Reel
250-XHHW2-RL-1000	1,000 ft Reel
300-XHHW2-RL-1000	1,000 ft Reel
350-XHHW2-RL-1000	1,000 ft Reel
400-XHHW2-RL-1000	1,000 ft Reel
500-XHHW2-RL-1000	1,000 ft Reel
600-XHHW2-RL-1000	1,000 ft Reel
700-XHHW2-RL-1000	1,000 ft Reel
750-XHHW2-RL-1000	1,000 ft Reel
900-XHHW2-RL-1000	1,000 ft Reel
1000-XHHW2-RL-1000	1,000 ft Reel

AL CONDUCTOR



XL INSULATION

VOLTAGE RATING

600-1000V

TEMPERATURE RATING

90° C wet or dry

METAL

8176 Aluminum Alloy

INSULATION MATERIAL

XLPE Compound





Service Entrance Cable Type R

Aluminum
Wire



AMMO#	SIZE AWG & CONSTRUCTION	LENGTH
SER-3C250-3/0G-2000	250-250-250-250-3/0	2000 FT Reel
SER-3C4/0-2/0G-2500	4/0-4/0-4/0-2/0	2500 FT Reel
SER-3C3/0-1/0G-2500	3/0-3/0-3/0-1/0	2500 FT Reel
SER-3C2/0-1G-1500	2/0-2/0-2/0-1	1500 FT Reel
SER-3C1/0-2G-1500	1/0-1/0-1/0-2	1500 FT Reel
SER-3C1-3G-2500	1-1-1-3	2500 FT Reel
SER-3C2-4G-2000	2-2-2-4	2000 FT Reel
SER-3C4-6G-2500	4-4-4-6	2500 FT Reel
SER-3C6-6G-5000	6-6-6-6	5000 FT Reel
SER-3C8-8G-5000	8-8-8-8	5000 FT Reel



ELECTRICAL WIRE

Underground Distribution Cable Type Triplex

1350 Series
Aluminum



AMMO#	SIZE AWG & CONSTRUCTION	LENGTH
2-S-A1350-4000	STEPHENS 2-2-4	4000 FT Reel
4/0-SW-A1350-2000	SWEETBRIAR 4/0-4/0-2/0	2000 FT Reel
250-P-A1350-3000	PRATT 250-250-3/0	3000 FT Reel

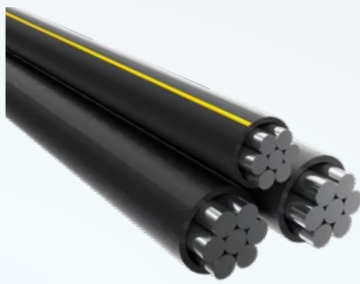

2-S-A1350-4000



4/0-SW-A1350-2000

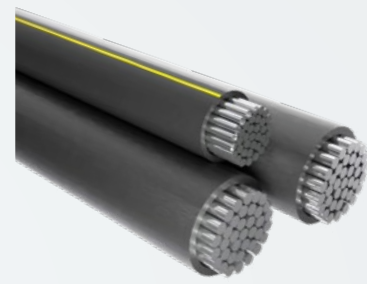

250-P-A1350-3000

Underground Distribution Cable Type Quadruplex

1350 Series
Aluminum



AMMO#	SIZE AWG & CONSTRUCTION	LENGTH
2-D-A1350-4000	DYKE 2-2-2-4	4000 FT Reel
4/0-WF-A1350-3000	WAKE FOREST 4/0-4/0-4/0-2/0	2000 FT Reel
250-R-A1350-2500	RUST 250-250-250-3/0	3000 FT Reel

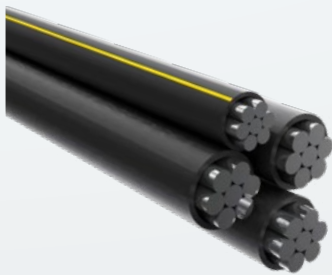

2-D-A1350-4000

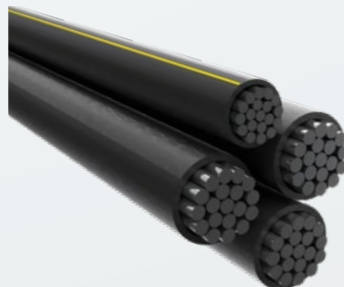

4/0-WF-A1350-3000

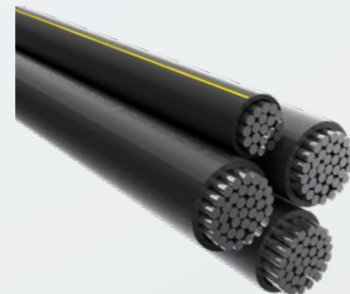

250-R-A1350-2500

GFCI'S & USB Devices _____	298
Residential Switch _____	300
Residential Receptacle _____	302
Industrial Receptacles & Plugs _____	308
Metal Wallplates _____	310
Plastic Wallplates _____	314
Red Indicator Plates _____	318
Ceiling Blank up Covers _____	319

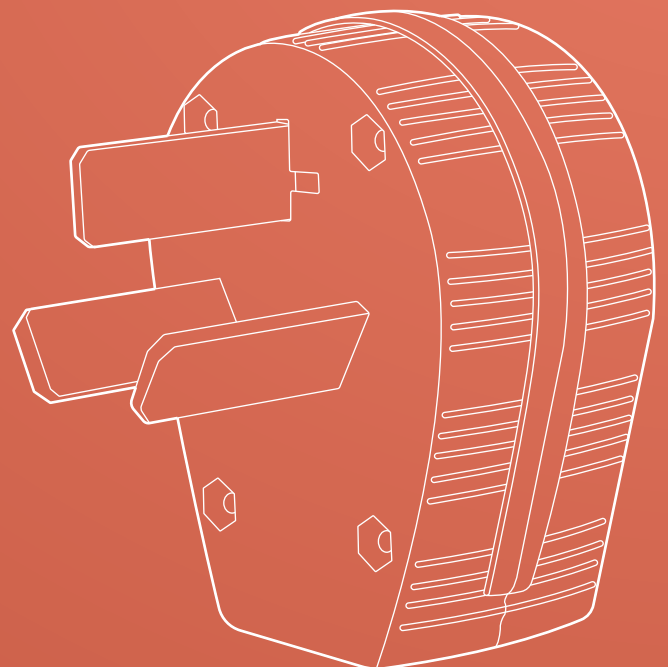
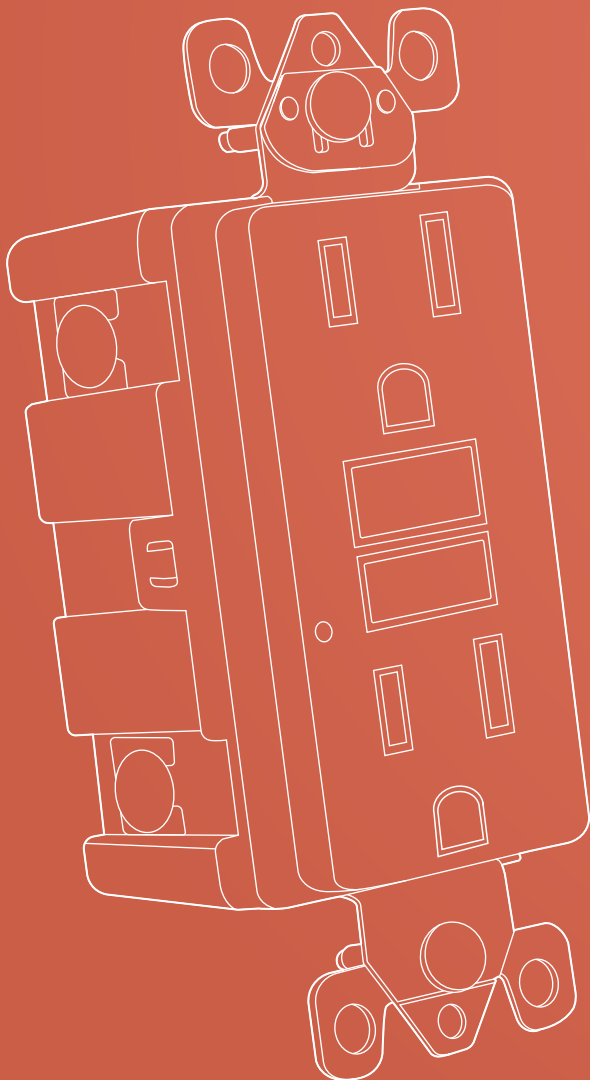



WIRING DEVICES





15IV-ST



15WH-ST



20IV-ST



20WH-ST



TR-15IV-ST



TR-15WH-ST



TR-20IV-ST



TR-20WH-ST



TR-15WH-ST-RB



TRWR-1-IV-ST



TRWR-1-W-ST



TRWR-2-IV-ST



TRWR-2-W-ST



TR-USB15-WH



TR-USB20-WH



DRTRUSB15-IV



DRTRUSB15-WH



DRTRUSB20-IV



DRTRUSB20-WH

GFCI & USB Devices



Versatile and reliable, our solutions are ideal for wet or damp locations from residential bathrooms and kitchens to public restrooms, commercial spaces, and social institutions.



AMMO#	DESCRIPTION	INNER	MASTER
15IV-ST	15A Self Test GFCI - Ivory	-	50
15WH-ST	15A Self Test GFCI - White	-	50
20IV-ST	20A Self Test GFCI - Ivory	-	50
20WH-ST	20A Self Test GFCI - White	-	50
TR-15IV-ST	15A Self Test Tamper Resistant GFCI - Ivory	-	50
TR-15WH-ST	15A Self Test Tamper Resistant GFCI - White	-	50
TR-20IV-ST	20A Self Test Tamper Resistant GFCI - Ivory	-	50
TR-20WH-ST	20A Self Test Tamper Resistant GFCI - White	-	50
TR-15WH-ST-RB	15A Self Test Tamper Resistant GFCI Red & Blue	-	50
TRWR-1-IV-ST	15A GFCI Tamper & Weather Resistant Self Test - Ivory	-	50
TRWR-1-W-ST	15A Tamper Resistant Weather Resistant Self Test - White	-	50
TRWR-2-IV-ST	20A GFCI Tamper & Weather Resistant Self Test - Ivory	-	50
TRWR-2-W-ST	20A GFCI Tamper Resistant Weather Resistant Test - White	-	50
TR-USB15-WH	125V, 15A Tamper Resistant, 4.2 A USB Receptacle - White	-	60
TR-USB20-WH	125V, 20A Tamper Resistant, 4.2 A USB Receptacle - White	-	60
DRTRUSB15-IV	Decorator Receptacle, 15A-125V, Tamper Resistant, Dual USB Charger Output 4.2A - Ivory	10	100
DRTRUSB15-WH	Decorator Receptacle, 15A-125V, Tamper Resistant, Dual USB Charger Output 4.2A - White	10	100
DRTRUSB20-IV	Decorator Receptacle, 20A-125V, Tamper Resistant, Dual USB Charger Output 4.2A - Ivory	10	100
DRTRUSB20-WH	Decorator Receptacle, 20A-125V, Tamper Resistant, Dual USB Charger Output 4.2A - White	10	100

Residential Switches



 *Ideal for wet or damp locations, this compact, space-saving socket combines fast, convenient charging with sleek design.*

AMMO#	DESCRIPTION	INNER	MASTER
DSPS15-IV	Decorator Single Pole Switch, Rated 15A, 120-277V AC - Ivory	10	100
DSPS15-WH	Decorator Single Pole Switch, Rated 15A, 120-277V AC - White	10	100
D3WS15-IV	Decorator 3-Way Switch, Rated 15A, 120-277V AC - Ivory	10	100
D3WS15-WH	Decorator 3-Way Switch, Rated 15A, 120-277V AC - White	10	100
2DSPS15-IV	Two Single Pole Switches, Rated 15A, 120-277V AC - Ivory	10	100
2DSPS15-WH	Two Single Pole Switches, Rated 15A, 120-277V AC - White	10	100
DSP3WS15-IV	Decorator Single Pole & 3-Way Switches, Rated 15A, 120-277V AC - Ivory	10	100
DSP3WS15-WH	Decorator Single Pole & 3-Way Switches, Rated 15A, 120-277V AC - White	10	100
3DSPS15-IV	Three Single Pole Switches, Rated 15A, 120-2E2:E60C - Ivory	10	100
3DSPS15-WH	Three Single Pole Switches, Rated 15A, 120-2E2 - White	10	100
SPTS15-IV	Single Pole Toggle Switch, Rated 15A, 120-277V AC - Ivory	10	100
SPTS15-WH	Single Pole Toggle Switch, Rated 15A, 120-277V AC - White	10	100
3WTS15-IV	3-Way Toggle Switch, Rated 15A, 120-277V AC - Ivory	10	100
3WTS15-WH	3-Way Toggle Switch, Rated 15A, 120-277V AC - White	10	100
DPTS20-IV	Double Pole Toggle Switch, Rated 20A, 120-277V AC - Ivory	10	100
DPTS20-WH	Double Pole Toggle Switch, Rated 20A, 120-277V AC - White	10	100
DPTS30-IV	Double Pole Toggle Switch, Rated 30A, 120-277V AC - Ivory	10	100
DPTS30-WH	Double Pole Toggle Switch, Rated 30A, 120-277V AC - White	10	100



DSPS15-IV



DSPS15-WH



D3WS15-IV



D3WS15-WH



2DSPS15-IV



2DSPS15-WH



DSP3WS15-IV



DSP3WS15-WH

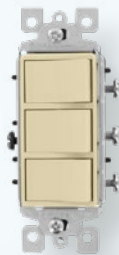

3DSPS15-IV



3DSPS15-WH



SPTS15-IV



SPTS15-WH



3WTS15-IV



3WTS15-WH



DPTS20-IV



DPTS20-WH



DPTS30-IV



DPTS30-WH



SR120-IV



SR120-WH



SR220-IV



SR220-WH



SR115-IV



SR115-WH



SR220R-IV



SR220R-WH

Residential Receptacles



Perfect for wet or damp locations, this sleek, space-saving socket offers fast, convenient charging for all spaces.



AMMO#	DESCRIPTION	INNER	MASTER
SR120-IV	Single Receptacle, Rated 20A, 125V - Ivory	10	100
SR120-WH	Single Receptacle, Rated 20A, 125V - White	10	100
SR220-IV	Single Receptacle, Rated 20A, 125-250V, 10-20R - Ivory	10	100
SR220-WH	Single Receptacle, Rated 20A, 125-250V, 10-20R - White	10	100
SR115-IV	Single Receptacle, Rated 15A, 125V - Ivory	10	100
SR115-WH	Single Receptacle, Rated 15A, 125V - White	10	100
SR220R-IV	Single Receptacle, Rated 20A, 125-250V, 6-20R - Ivory	10	100
SR220R-WH	Single Receptacle, Rated 20A, 125-250V, 6-20R - White	10	100

Residential Receptacles



AMMO#	DESCRIPTION	INNER	MASTER
DDR15-IV	Decorator Duplex Receptacle, Rated 15A, 125V - Ivory	10	100
DDR15-WH	Decorator Duplex Receptacle, Rated 15A, 125V - White	10	100
DRTR15-IV	Duplex Receptacle, Rated 15A, 125V, Tamper Resistant - Ivory	10	100
DRTR15-WH	Duplex Receptacle, Rated 15A, 125V, Tamper Resistant - White	10	100
DDTTSGTR20-IV	Decorator Receptacle, Rated 20A, 125V, Self-Grounding, Tamper Resistant - Ivory	10	100
DDTTSGTR20-WH	Decorator Receptacle, Rated 20A, 125V, Self-Grounding, Tamper Resistant - White	10	100
DDRRTR15-IV	Decorator Duplex Receptacle, Rated 15A, 125V, Tamper Resistant - Ivory	10	100
DDRRTR15-WH	Decorator Duplex Receptacle, Rated 15A, 125V, Tamper Resistant - White	10	100
DR-1-WH	Duplex Receptacle, Flat Hole - White	10	100
AR15AADJR	Decorator Receptacle, White Switch, 15A, 125V	-	25



Sleek and compact, this socket delivers fast charging and is ideal for wet or damp areas in any setting.

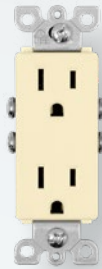

DDR15-IV



DDR15-WH



DRTR15-IV



DRTR15-WH



DDTTSGTR20-IV



DDTTSGTR20-WH



DDRTR15-IV



DDRTR15-WH



DR-1-WH



AR15AADJR



DR15-IV



DR15-WH



DR15-BK



DRSG15-IV



DRSG15-WH



DRSG20-IV



DRSG20-WH



DRSG15-2-IV



DRSG15-2-WH



DRSG20-2-IV



DRSG20-2-WH



DRSGTR20-IV



DRSGTR20-WH

WIRING DEVICES



Residential Receptacles

AMMO#	DESCRIPTION	INNER	MASTER
DR15-IV	Duplex Receptacle, Rated 15A, 125V - Ivory	10	100
DR15-WH	Duplex Receptacle, Rated 15A, 125V - White	10	100
DR15-BK	Duplex Receptacle, Rated 15A, 125V - Black	10	100
DRSG15-IV	Duplex Receptacle, Rated 15A, 125V, Self-Grounding - Ivory	10	100
DRSG15-WH	Duplex Receptacle, Rated 15A, 125V, Self-Grounding - White	10	100
DRSG20-IV	Duplex Receptacle, Rated 20A, 125V, Self-Grounding - Ivory	10	100
DRSG20-WH	Duplex Receptacle, Rated 20A, 125V, Self-Grounding - White	10	100
DRSG15-2-IV	Duplex Receptacle, Rated 15A, 250V, Self-Grounding - Ivory	10	100
DRSG15-2-WH	Duplex Receptacle, Rated 15A, 250V, Self-Grounding - White	10	100
DRSG20-2-IV	Duplex Receptacle, Rated 20A, 250V, Self-Grounding - Ivory	10	100
DRSG20-2-WH	Duplex Receptacle, Rated 20A, 250V, Self-Grounding - White	10	100
DRSGTR20-IV	Duplex Receptacle, Rated 20A, 125V, Self-Grounding, Tamper Resistant - Ivory	10	100
DRSGTR20-WH	Duplex Receptacle, Rated 20A, 125V, Self-Grounding, Tamper Resistant - White	10	100



Designed for all spaces, this compact, space-saving socket is perfect for wet or damp locations, combining sleek aesthetics with fast and convenient charging, making it an essential upgrade for any modern environment.



RSS50-BK



303P3W



503P4W



302P3W



502P3W



303P3WSF



502P3WF



503P4WSF



302P3WSF



503P3WSFM

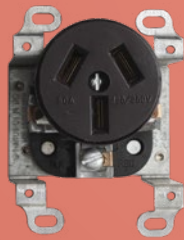

503P3WSF



IP650P



IP1050P



IP1030P



IP1430/50P

Coming soon!



303P4WSF

Industrial Receptacles & Plugs



Ideal for new or renovated spaces, this durable thermoplastic outlet offers easy wiring, flush-mount design, and heavy-duty copper contacts, perfect for homes, schools, and healthcare facilities.



AMMO#	DESCRIPTION	NEMA	INNER	MASTER
RSS50-BK	Recp Single Superficial 50A, 125-250V, 10-50R 3P3W - Black	10-50R	1	100
303P3W	Recp Single Superficial 30A, 125-250V 3P3W - Black	10-30R	1	100
503P4W	Recp Single Superficial 50A, 125-250V 3P4W - Black	14-50R	1	100
302P3W	Recp Single Superficial 30A, 250V 2P3W - Black	6-30R	1	100
502P3W	Recp Single Superficial 50A, 250V, 2P3W - Black	6-50R	1	100
303P3WSF	Recp 30A, 125-250V 3P3W Str Flush Mnt - Black	10-30R	1	100
502P3WF	Recp Single Superficial 50A, 250V, 2P3W - Black	6-50R	1	100
503P4WSF	Recp Single Flush 50A, 125-250V 3P4W - Black	14-50R	1	100
302P3WSF	Recp Single Flush 30A, 250V 2P3W - Black	6-30R	1	100
503P3WSFM	Recp 50A, 125-250V 3P3W Str Flush Mnt - Black	10-50R	1	100
503P3WSF	Recp 50A, 125-250V 3P3W Str Flush Mnt - Black	10-50R	1	100
IP650P	Industrial Plug, 30A-50A, 250V, 6-50P - Black	6-30P	1	100
IP1050P	Industrial Plug, 50A, 125-250V, 10-50P - Black	10-50P	1	100
IP1030P	Industrial Plug, 30A, 125-250V, 10-30P - Black	10-30P	1	100
IP1430/50P	Industrial Plug, 30A-50A, 125-250V, 14-50P - Black	14-50P	1	100
303P4WSF	Industrial Receptacle, 30AMP, 125-250V, Flush Mounting	14-30P	10	100

Metal Wallplates



AMMO#	DESCRIPTION	PKG
AR-WJD1	Jumbo, 1 Gang, Duplex, Smooth - White	100
AR-WJR1	Jumbo, 1 Gang, Decorator, Smooth - White	100
AR-WJT1	Jumbo, 1 Gang, Toggle, Smooth - White	100
AR-WJTT1	Jumbo, 2 Gang Toggle/Toggle, Smooth - White	100
AR-WMB3	Max, 1 Gang, Blank, Texture - White	100
AR-WMD1	Max, 1 Gang, Duplex, Smooth - White	100
AR-WMD3	Max, 1 Gang, Duplex, Texture - White	100
AR-WMR3	Max, 1 Gang, Decorator, Texture - White	100
AR-WMT1	Max, 1 Gang, Toggle, Smooth - White	100



AR-WJD1



AR-WJR1



AR-WJT1



AR-WJTT1



AR-WMB3



AR-WMD1



AR-WMD3



AR-WMR3



AR-WMT1



AR-WMT3



AR-WPR1



AR-WPDD3



AR-WPRR3



AR-WPTD3

Coming soon!



AR-WPTR1



AR-WPTR3



AR-WPTT1



AR-WPTTT3



WP2G-WH

Metal Wallplates

White



AMMO#	DESCRIPTION	PKG
AR-WMT3	Max, 1 Gang, Toggle, Texture - White	100
AR-WPR1	Princess, 1 Gang, Rocker, Smooth - White	100
AR-WPDD3	Princess, 2 Gang, Duplex/Duplex, Texture - White	100
AR-WPRR3	Princess, 2 Gang, Rocker/Rocker, Texture - White	100
AR-WPTD3	Princess, 2 Gang, Toggle/Duplex, Texture - White	100
AR-WPTR1	Princess, 2 Gang, Toggle/Rocker, Smooth - White	100
AR-WPTR3	Princess, 2 Gang, Toggle/Decorator, Texture - White	100
AR-WPTT1	Princess, 2 Gang, Toggle/Toggle, Smooth - White	100
AR-WPTTT3	Princess, 3 Gang, Toggle/, Texture - White	100
WP2G-WH	Standard size, 2 Gang, 2.15" Dia. - White	100

Metal Wallplates

Ivory



AMMO#	DESCRIPTION	PKG
AR-WJD2	Jumbo, 1 Gang, Duplex, Smooth - Ivory	100
AR-WJD4	Jumbo, 1 Gang, Duplex, Texture - Ivory	100
AR-WJT2	Jumbo, 1 Gang, Toggle, Smooth - Ivory	100
AR-WJT4	Jumbo, 1 Gang, Duplex, Texture - Ivory	100
AR-WJTT2	Jumbo, 2 Gang Toggle/Toggle, Smooth - Ivory	100
AR-WJTT4	Jumbo, 2 Gang Toggle/Toggle, Texture - Ivory	100
AR-WSB2	Standard, 1 Gang, Blank, Smooth - Ivory	100
AR-WSD2	Standard, 1 Gang, Duplex, Smooth - Ivory	100
AR-WST2	Standard, 1 Gang, Toggle, Smooth - Ivory	100
AR-WSTD2	Standard, 2 Gang, Toggle/Duplex Smooth - Ivory	100



AR-WJD2



AR-WJD4



AR-WJT2



AR-WJT4



AR-WJTT2



AR-WJTT4



AR-WSB2



AR-WSD2



AR-WST2



AR-WSTD2

Metal Wallplates

Stainless



AMMO#	DESCRIPTION	PKG
AR-WSST	Stainless, 1 Gang , Toggle	100
AR-WSSD	Stainless, 1 Gang , Duplex	100
AR-WSSB	Stainless, 1 Gang , Blank	100



AR-WSST

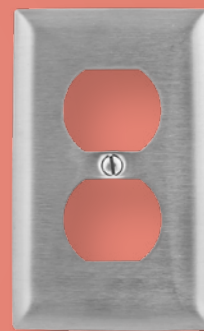

AR-WSSD



AR-WSSB

Plastic Wallplates



AMMO#	DESCRIPTION	INNER	MASTER
BWP-WH	Blank Wallplate - White	20	100
WPFTS-WH	Wallplate For Toggle Switch - White	20	100
DWP1-WH	Decorator Wallplate - White	20	100
WP2R-WH	Wallplate For Duplex Receptacle - White	20	100
WPSR-WH	Wallplate For Single Receptacle - White	20	100
M1PF-WH	Midsize Single Port Faceplate - White	20	100
M2PF-WH	Midsize Dual Port Faceplate - White	20	100
M3PF-WH	Midsize Triple Port Faceplate - White	20	100
M4PF-WH	Midsize Quad Port Faceplate - White	20	100

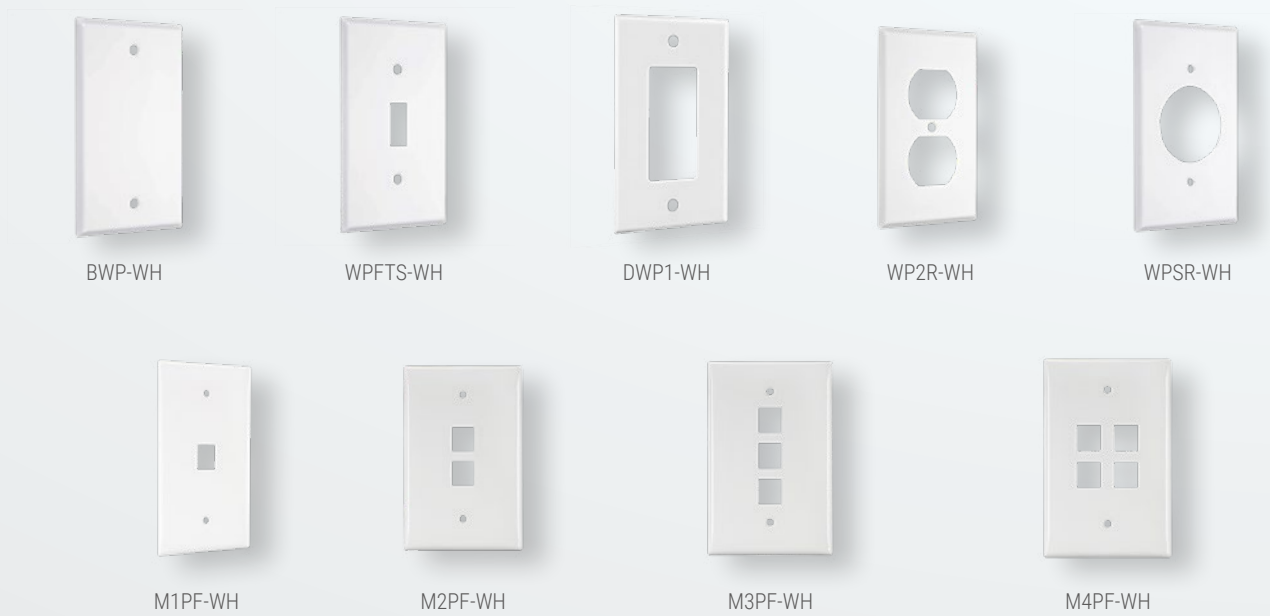

BWP-WH

WPFTS-WH

DWP1-WH

WP2R-WH

WPSR-WH

M1PF-WH

M2PF-WH

M3PF-WH

M4PF-WH



2BWP-WH



2BWPTS-WH



2BWPTSD-WH



2DWP-WH



2WPDR-WH



WPTSDR-WH



WPDRD-WH



3WPTS-WH



3DWP-WH

Plastic Wallplates

White



AMMO#	DESCRIPTION	INNER	MASTER
2BWP-WH	2-Gang Blank Wallplate - White	20	100
2BWPTS-WH	2-Gang Wallplate For Toggle Switch - White	20	100
2BWPTSD-WH	Wallplate For Toggle Switch And Decorator - White	20	100
2DWP-WH	2-Gang Decorator Wallplate - White	20	100
2WPDR-WH	2-Gang Wallplate For Duplex Receptacle - White	20	100
WPTSDR-WH	Wallplate For Toggle Switch And Duplex Receptacle - White	20	100
WPDRD-WH	Wallplate For Duplex Receptacle And Decorator - White	20	100
3WPTS-WH	3-Gang Wallplate For Toggle Switch - White	20	100
3DWP-WH	3-Gang Decorator Wallplate - White	20	100

Plastic Wallplates

Ivory



AMMO#	DESCRIPTION	INNER	MASTER
BWP-IV	Blank Wallplate - Ivory	20	100
WPFTS-IV	Wallplate For Toggle Switch - Ivory	20	100
DWP1-IV	Decorator Wallplate - Ivory	20	100
WP2R-IV	Wallplate For Duplex Receptacle - Ivory	20	100
WPSR-IV	Wallplate For Single Receptacle - Ivory	20	100
M1PF-IV	Midsize Single Port Faceplate - Ivory	20	100
M2PF-IV	Midsize Dual Port Faceplate - Ivory	20	100
M3PF-IV	Midsize Triple Port Faceplate - Ivory	20	100
M4PF-IV	Midsize Quad Port Faceplate - Ivory	20	100



BWP-IV



WPFTS-IV



DWP1-IV



WP2R-IV



WPSR-IV



M1PF-IV



M2PF-IV



M3PF-IV



M4PF-IV

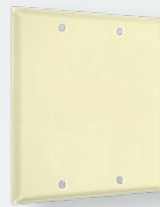

2BWP-IV



2BWPTS-IV



2BWPTSD-IV



2DWP-IV



2WPDR-IV



WPTSDR-IV



WPDRD-IV



3WPTS-IV

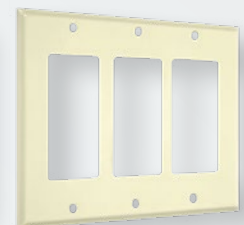

3DWP-IV

Plastic Wallplates

Ivory



AMMO#	DESCRIPTION	INNER	MASTER
2BWP-IV	2-Gang Blank Wallplate - Ivory	20	100
2BWPTS-IV	2-Gang Wallplate For Toggle Switch - Ivory	20	100
2BWPTSD-IV	Wallplate For Toggle Switch And Decorator - Ivory	20	100
2DWP-IV	2-Gang Decorator Wallplate - Ivory	20	100
2WPDR-IV	2-Gang Wallplate For Duplex Receptacle - Ivory	20	100
WPTSDR-IV	Wallplate For Toggle Switch And Duplex Receptacle - Ivory	20	100
WPDRD-IV	Wallplate For Duplex Receptacle And Decorator - Ivory	20	100
3WPTS-IV	3-Gang Wallplate For Toggle Switch - Ivory	20	100
3DWP-IV	3-Gang Decorator Wallplate - Ivory	20	100

Red Indicator Plates



AMMO#	SIZE	DESCRIPTION	PKG
ARWE1-T	4.114" x 2.238"	Emergency Wallplate, Utility	100
ARW01-T	4.114" x 2.238"	Oil Wallplate, Utility	100
ARWG1-T	4.114" x 2.238"	Gas Wallplate, Utility	100
ARWE2-T	4.5" x 2.75"	Emergency Wallplate, Standard	100
ARW02-T	4.5" x 2.75"	Oil Wallplate, Standard	100
ARWG2-T	4.5" x 2.75"	Gas Wallplate, Standard	100
ARWE3-T	4" x 4"	Emergency Wallplate, Square	100
ARW03-T	4" x 4"	Oil Wallplate, Square	100
ARWG3-T	4" x 4"	Gas Wallplate, Square	100



ARWE1-T



ARW01-T



ARWG1-T



ARWE2-T



ARW02-T



ARWG2-T



ARWE3-T



ARW03-T



ARWG3-T

Ceiling Blank up Covers



AMMO#	DESCRIPTION	SCREW SEPARATION	PKG
AR-WR3	Round Plate, Blank, Texture White 5"	2-3/4"	100
AR-WR5	Round Plate, Blank, Texture White 5"	3-1/2"	100



AR-WR3



AR-WR5

Lampholders _____	322
Vaportight Light Fixtures _____	325
Exit Signs _____	326
Emergency LED _____	327
Temporary Light Fixtures _____	328
Lamps _____	329
LED Work Light _____	330
LED String _____	331

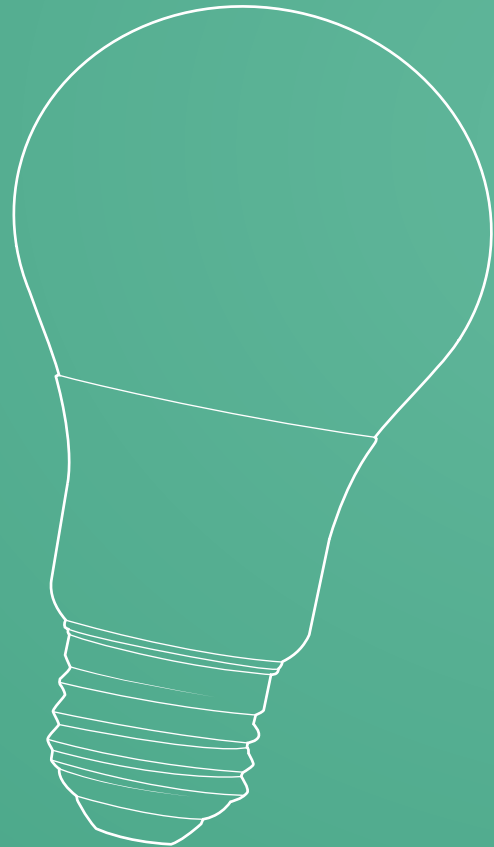
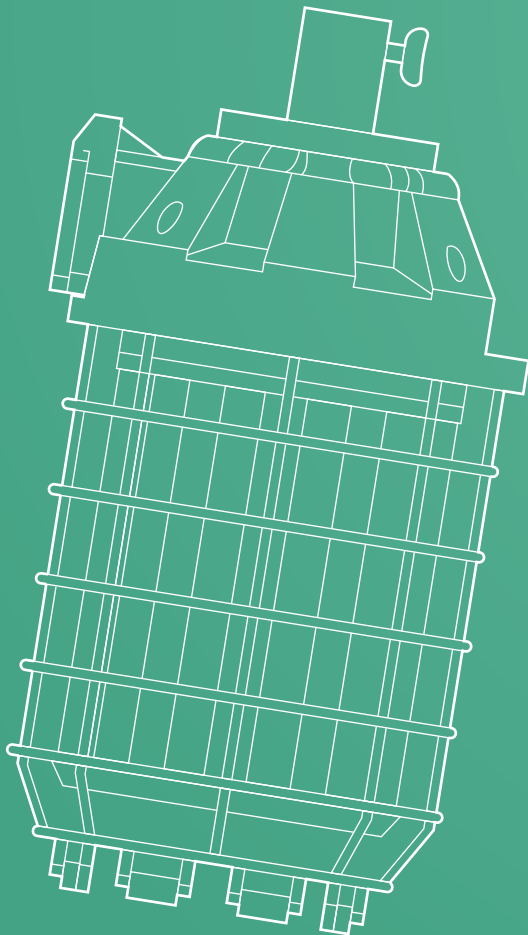



LIGHTING AND ACCESSORIES



Lampholders



ARRC-3+2LH150-5



ARLH150-5



AR-WPRLH

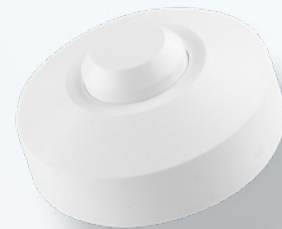

MSS1

AMMO#	SIZE	COLOR	INNER	MASTER
ARLH150-5	120 Par38 150w Lampholder With Outer Gasket	Gray	-	50
ARRC-3+2LH150-5	120 Par38 150w Lampholder With Round Cover	Gray	-	50
AR-WPRLH	Weatherproof Rubber Coated Lamp Holder, 600w, 250v ,14 Awg	Black/White	20	200
MSS1	Motion Sensor Switch	White	-	50

Round Lampholder Covers



AMMO#

ARXC-1

ARXC-2

ARRC-1

ARRC-2

OUTLET HOLES

1

2

1

2

HOLE SIZE

1/2"

3/4"

1/2"

1/2"

COLOR

Gray

Gray

Gray

Gray

PKG

50

50

50

50

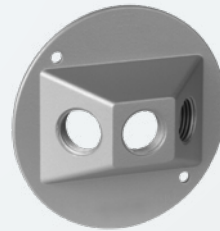
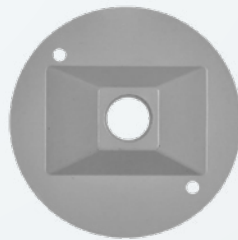

AMMO#

ARRC-3

ARRC-1-N

ARRC-3-N

OUTLET HOLES

3

1

3

HOLE SIZE

1/2"

1/2"

1/2"

COLOR

Gray

Gray

Gray

PKG

50

50

50

One Gang Lampholder Covers



ARRE-1

AMMO#
OUTLET HOLES
HOLE SIZE
COLOR
PKG

1
1/2"
Gray
50



ARRE-1-W

1
1/2"
White
50



ARRE-2

2
1/2"
Gray
50



ARRE-2-W

AMMO#
OUTLET HOLES
HOLE SIZE
COLOR
PKG

2
1/2"
White
50



ARRE-3

3
1/2"
Gray
50



ARRE-3-W

3
1/2"
White
50

Vapor Tight Light Fixture



ARVPF001



Surface Mount

ARVPF002



Wall Mount

AMMO#	DESCRIPTION	PKG
ARVPF001	Jvl100 Vapor Tight Surface Mount Fixture	6
ARVPF002	Jvl100b Vapor Tight Wall Mount Fixture	6



Ultra Slim Red LED Exit Sign



AMMO#	ARLEED2RWEM
Charging Time	24h
The AC Voltage	120- 277 V/ 60hz
Power	1.1w
Ac Charging Current	20 mA
Discharge Time	90mins
Luminous Flux	1.51lm
Color Temperature	1001k
PKG	6



Ultra Slim Green LED Exit Sign



AMMO#	ARLEED2GWEM
Charging Time	24h
The AC Voltage	120- 277 V/ 60hz
Power	1.1w
Ac Charging Current	20 mA
Discharge Time	90mins
Luminous Flux	1.51lm
Color Temperature	1001k
PKG	6



Ultra Slim Red LED Exit/Emergency Combo



AMMO#	ARLECD2RW
The AC Voltage	120- 277 V/ 60hz
Input Power	2w
Ac Charging Current	32mA
Discharge Time	90mins
Charging Time	24h
Luminous Flux (AC)	5lm
Color Temperature (AC)	1001K
Luminous Flux (DC)	100lm
Color Temperature (DC)	5000K
PKG	6

Ultra Slim Green LED Exit/Emergency Combo



AMMO#	ARLECD2GW
The AC Voltage	120- 277 V/ 60hz
Input Power	2w
Ac Charging Current	32mA
Discharge Time	90mins
Charging Time	24h
Luminous Flux (Ac)	5 Lm
Color Temperature (Ac)	1001k
Luminous Flux (Dc)	100lm
Color Temperature (Dc)	50000k
PKG	6

Emergency LED



AMMO#	DESCRIPTION	INNER	MASTER
ARLEU9L	UI/Cul Twin Head LED Emergency Light, White, 2*8pcs 2835 Smt Led, 90min.	1	6



Colored Temporary Light Fixtures with Lamp



ARLTR-G

Temporary Light Fixture
Green Color With 110 105w
6500k Bulb

1



ARLTR-Y

Temporary Light Fixture
Yellow Color With 110 105w
6500k Bulb

1



ARLTR-R

Temporary Light Fixture Red
Color With 110 105w 6500k
Bulb

1



ARLTR-OR

Temporary Light Fixture
Orange Color With 110 105w
6500k Bulb

1



ARLTR-W

Temporary Light Fixture
White Color With 110 105w
6500k Bulb

1

AMMO#

DESCRIPTION

PKG

AMMO#

DESCRIPTION

PKG

Lamps



AMMO#	LM	TEMP	WATTS	BASE	INNER	MASTER
A1910WL	800LM	5000K	9W	E26	4	32
A1912WL5	950LM	6500K	12W	E26	4	32
A1912WL6	850LM	6500K	12W	E26	4	32
A19-930	800LM	3000K	9W	E26	-	6
A19-950	800LM	5000K	9W	E26	-	6



A1910WL



A1912WL5



A19-930 /
A19-950

LED Work Light



AMMO#	TEMP	WATTS	VOLTAGE	INNER	MASTER
-------	------	-------	---------	-------	--------

TM-100W	5000K	110W	120V	1	4
---------	-------	------	------	---	---

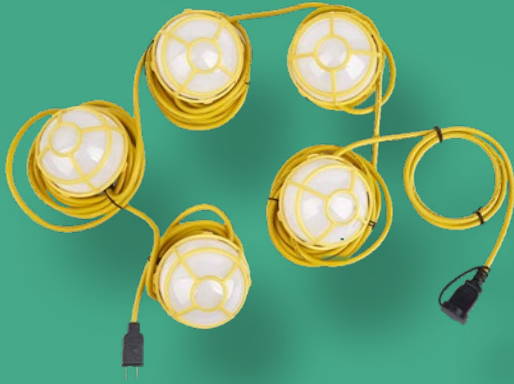

LED String Lights



AMMO#	TLE/50	TLE/100
DESCRIPTION	Led String Lights 50ft 18/3 SjtW AC 120v	Led String Lights 100ft 18/3 SjtW AC 120v
COLOR TEMPERATURE	6500K	6500K
PKG	4	2



Portable String Light



AMMO#	TLS/100
LENGTH	100 ft
PKG	1



Cages

AMMO#	ARYC1
DESCRIPTION	Temporary Light Cage
INNER	100
MASTER	1000

Guy Clamps _____	334
Wire Rope Clips _____	334
Support Grip _____	334
Pipe Mounting Wireholders _____	335
Bolt & Anchors _____	336
Cable Storage Brackets _____	340
Nuts _____	341
Washers _____	341
Chains _____	342
Batteries _____	343

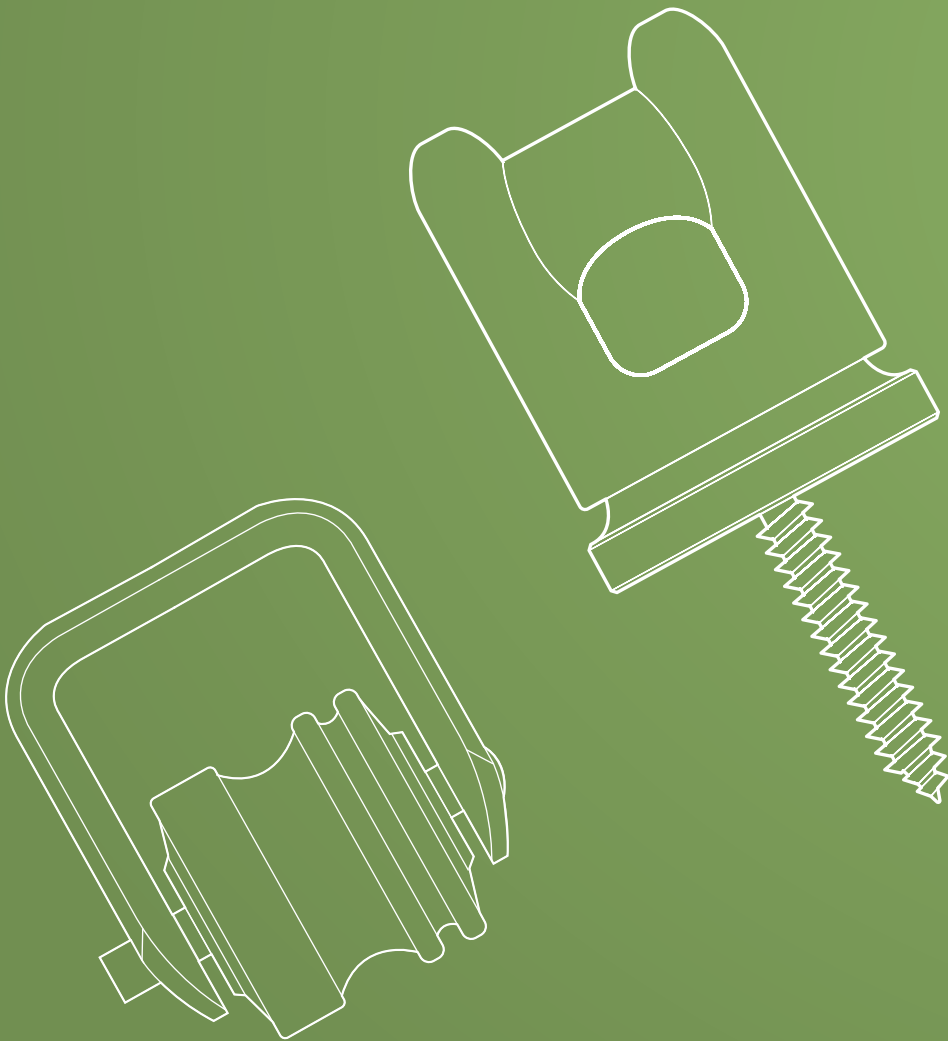



LINE SUPPLIES



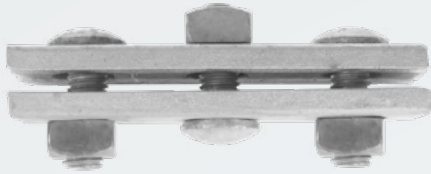

Guy Clamps

AMMO#	DESCRIPTION	PKG
ARGC001	2 Bolt 3-3/8" Length For 3/16" Through 7/16" Strand	25
ARGC002	3 Bolt 6" Length For 3/16" Through 7/16" Strand	20

Wire Rope Clips

AMMO#	DESCRIPTION	PKG
ARWRC14	Wire Rope Clips Cable Size 1/4"	200
ARWRC38	Wire Rope Clips Cable Size 3/8"	75



Support Grip Wire Cable Drop

Stainless Steel



AMMO#	DESCRIPTION	PKG
AR-BDSG	Bus Drop Single Eye Closed Mesh 1.0-1.30"	1

Pipe Mounting & Wireholders



- ARPMWH001
- ARPMWH002



- ARPMWH005



- ARPMWH006

AMMO#	DESCRIPTION	PKG
ARPMWH001	Pipe Mounting Wireholders "Universal" Reinforced Pipe Size 1-1/4"-3"	25
ARPMWH002	Pipe Mounting Wireholders "Universal" Reinforced Pipe Size 3"-4"	25
ARPMWH003	Clevises Extension 4", Mounting Hole 11/16", Steel Size 3/16" X 1-1/2"	10
ARPMWH004	Clevises Extension 4", Mounting Hole 11/16" X 7/8", Steel Size 3/16" X 3"	10
ARPMWH005	Reinforced Type Screw Hot Galv, Screw L=2-1/4"	25
ARPMWH006	Strain Insulators L=3-1/2", Dia.=2-1/2", Hole=5/8"	50

- ARPMWH003

- ARPMWH004



Bolts & Anchors



Machine Bolts

AMMO#	DESCRIPTION	PKG
ARMB5884	Machine Bolts Size 5/8" x 8", Thread Length 4"	50
ARMB58104	Machine Bolts Size 5/8" x 10", Thread Length 4"	25
ARMB58126	Machine Bolts Size 5/8" x 12", Thread Length 6"	25
ARMB58146	Machine Bolts Size 5/8" x 14", Thread Length 6"	25
ARMB58166	Machine Bolts Size 5/8" x 16", Thread Length 6"	25
ARMB58186	Machine Bolts Size 5/8" x 18", Thread Length 6"	25



Oval Eye Bolts

AMMO#	DESCRIPTION	PKG
ARCBOLT5884	Oval Eye Bolts Size 5/8" x 8", Thread Length 4"	25
ARCBOLT58104	Oval Eye Bolts Size 5/8" x 10", Thread Length 4"	25
ARCBOLT58126	Oval Eye Bolts Size 5/8" x 12", Thread Length 6"	25



Anchors Screw Type

AMMO#	DESCRIPTION	PKG
ARSA5836	Anchors-Screw Type Road Size 5/8" x 36", Wing Dia 4"	250
ARSA5848	Anchors-Screw Type Road Size 5/8" x 48", Wing Dia 4"	250
ARSA5860	Anchors-Screw Type Road Size 5/8" x 60",Wing Dia 4"	250
ARSA3448	Anchors-Screw Type Road Size 3/4" x 48",Wing Dia 6"	250
ARSA3460	Anchors-Screw Type Road Size 3/4" x 60",Wing Dia 6"	250



Strand Eye Bolts Straight & Angle

AMMO#	DESCRIPTION	PKG
ARSEBS5810	Strand Eye Bolts-Straight & Angle Type Straight, Size 5/8" x 10"	25
ARSEBS5812	Strand Eye Bolts-Straight & Angle Type Straight, Size 5/8" x 12"	25
ARSEBA5810	Strand Eye Bolts-Straight & Angle Type Angle, Size 5/8" x 10"	25
ARSEBA5813	Strand Eye Bolts-Straight & Angle Type Angle, Size 5/8" x 12"	25



Anchor Rods

AMMO#	DESCRIPTION	PKG
AROD586	Anchor Rods 5/8" x 6ft - Single Eye	250
AROD348	Anchor Rods 3/4" x 8ft - Single Eye	250
AROD586D	Anchor Rods 5/8" x 6ft - Double Eye	250



Double Arming Bolts

AMMO#	DESCRIPTION	PKG
ARDAB5816	Double Arming Bolts 5/8" x 16"	25
ARDAB5818	Double Arming Bolts 5/8" x 18"	20
ARDAB5820	Double Arming Bolts 5/8" x 20"	20
ARDAB5822	Double Arming Bolts 5/8" x 22"	20
ARDAB5824	Double Arming Bolts 5/8" x 24"	20



Double Arming Eye Bolts

AMMO#	DESCRIPTION	PKG
ARDAIB5818	Double Arming Eye Bolts 5/8" x 18"-17" Thread	20



Expanding Anchors

AMMO#	DESCRIPTION	PKG
AREAB001	Expanding Anchors Hole Size 8" - with hole 5/8	4



Cable Storage Brackets

AMMO#	DESCRIPTION	PKG
ARSB-144FO	144FO 900MM x 900MM	1

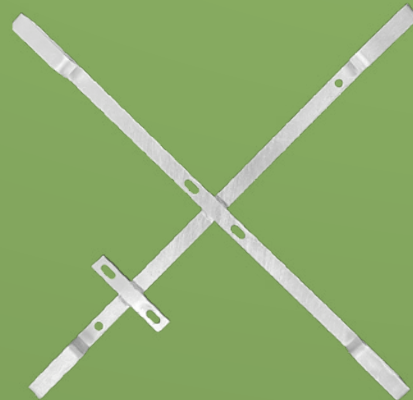

Nuts

AMMO#	DESCRIPTION	PKG
ARENUT58	Eye Nuts 5/8"	50
ARSN58	Square Nuts For 5/8" Bolts	400



• ARENUT58

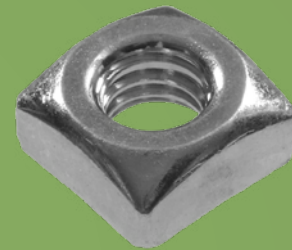

• ARSN58

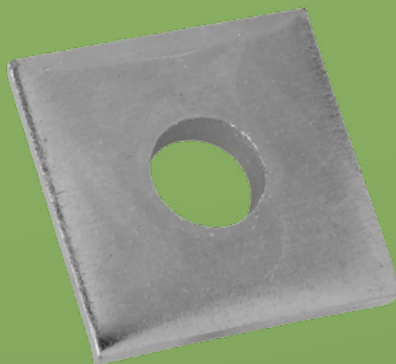

Square Washers

AMMO#	DESCRIPTION	PKG
ARSWASHER214	5/8" Sq. 2-1/4*2-1/4" x 2-1/4" x 3/16"	150

Chains



Coming soon!

Jack Chains Steel

AMMO#	DESCRIPTION	WORKING LOAD	PKG
ARJC-1	Jack Chains Gauge 12 Steel Static	43 LBS	100 ft box
ARJC-2	Jack Chains Gauge 12 Steel Static	29 LBS	100 ft Roll
ARJC-3	Jack Chains Gauge 12 Steel Static	29 LBS	50 ft box

Fluorescent Chain Steel

AMMO#	WORKING LOAD	INNER	MASTER
ARFC-1	50 LBS	1 YD	100 YD



Coming soon!

Battery



AMMO#	6V4AH	
DESCRIPTION	Sealed Lead Acid Battery - Black	
VOLTAGE	6V	
AMP HOURS	20 hours	4 AMP
DIMENSION	L	2.76 in
	W	1.85 in
	H	4.00 in
	TH	4.17 in
WEIGHT	1.54 LBS	
PKG	20	

Fans _____ 346
Fan Accessories _____ 352

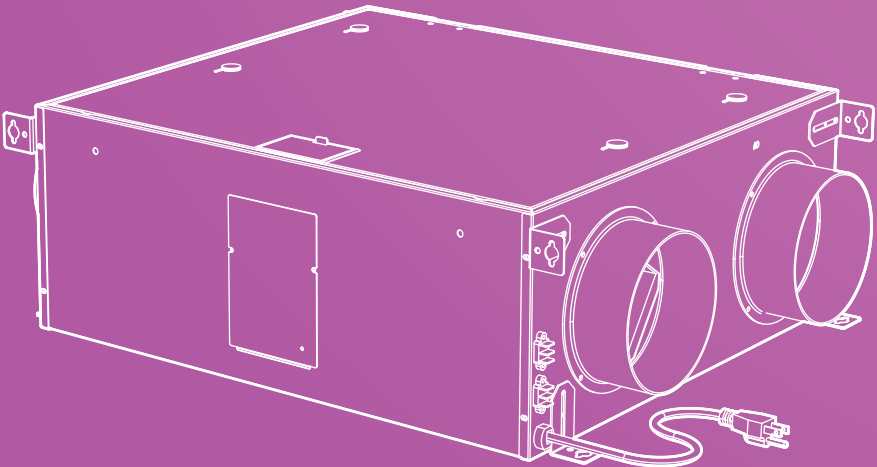
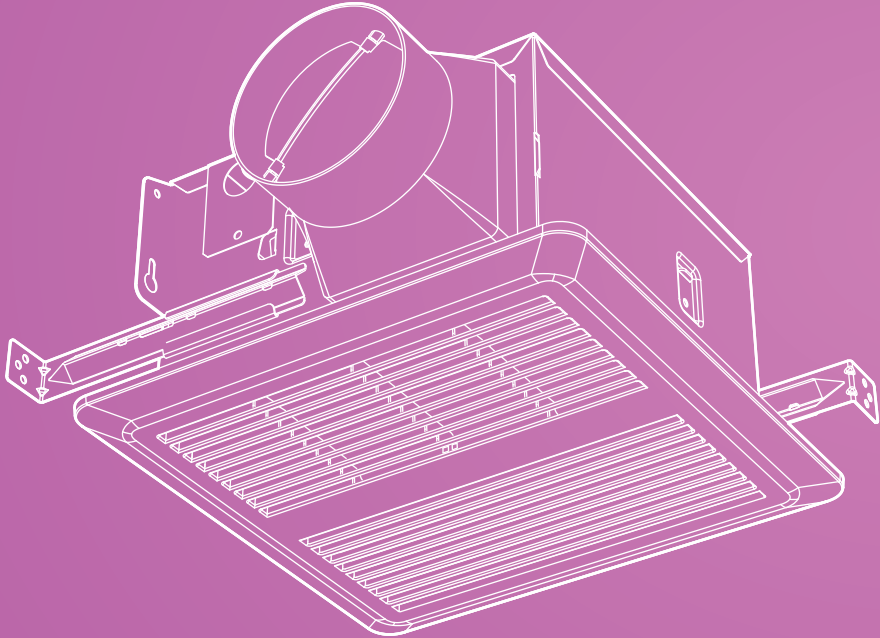



VENTILATION FANS



Ventilation Fans

Ventilator Fan

Galvanized Steel
with Plastic Grille



AMMO#	SIZE	CFM	MOTOR	PKG
ARS50	7 1/2" x 7 1/4" x 3 5/8"	50	AC Motor Economic Series	1
ARSD50	7 1/2" x 7 1/4" x 3 5/8"	50	DC Motor	1



Ventilator Fan

Galvanized Steel
with Plastic Grille



AMMO#	SIZE	CFM	MOTOR	PKG
ARS70	7 1/2" x 7 1/4" x 3 5/8"	70	AC Motor Economic Series	1



Ventilator Fan with Mounting Bracket

Galvanized Steel with Plastic Grille



AMMO#	SIZE	CFM	MOTOR	PKG
ARSP80	7 1/2" x 7 1/4" x 3 5/8"	80	DC Motor	1
ARSPD100-3	7 1/2" x 7 1/4" x 5 3/4"	50/80/100	DC Motor	1



Ventilator Fan with Mounting Bracket

Galvanized Steel with Plastic Grille



AMMO#	SIZE	CFM	MOTOR	PKG
ARSE110P	11 3/8" x 10 1/2" x 7 5/8"	110	AC Motor	1
ARSE120P	11 3/8" x 10 1/2" x 7 5/8"	120	AC Motor	1
ARSEPD140-3	7 1/2" x 7 1/4" x 3 5/8"	80/110/140	DC Motor With Humidity Sensor	1
ARSEP150	11 3/8" x 10 1/2" x 7 5/8"	150	AC Motor	1
ARSEP200	11 3/8" x 10 1/2" x 7 5/8"	190	AC Motor	1
ARSEPD200	11 3/8" x 10 1/2" x 7 5/8"	220	DC Motor	1
ARSEPD300	11 3/8" x 10 1/2" x 7 5/8"	290	DC Motor	1

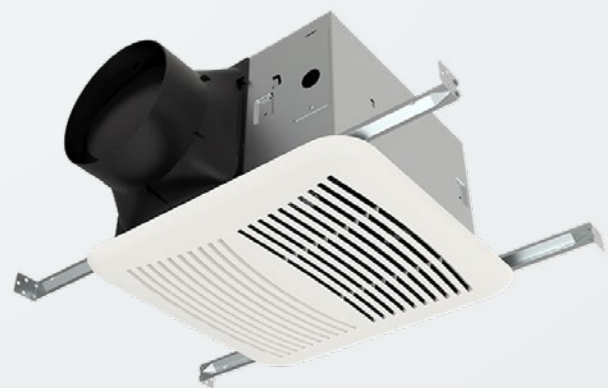

Ventilator Fan with Mounting Bracket

Galvanized Steel with Plastic Grille



AMMO#	SIZE	CFM	MOTOR	PKG
ARSNPD100-3	7 1/2" x 7 1/4" x 3 5/8"	50/80/100	DC Motor	1



Commercial Ventilator Fan

Galvanized Steel with Plastic Grille



AMMO#	SIZE	CFM	MOTOR	PKG
ARSED500-4	14 1/8" x 14 1/8" x 9"	200/300 400/500	DC Motor	1



Fully enclosed AC and compact blower system ensure high performance and ultra quiet operation



Applicable to the bathroom, bedroom, cloakroom and other enclosed spaces that need to reduce moisture and smelliness





Energy Recovery Ventilator

Galvanized Steel



AMMO#	SIZE	MOTOR	PKG
ARERV100EC	28 1/2"x 23" x 8 7/8"	AC Motor	1

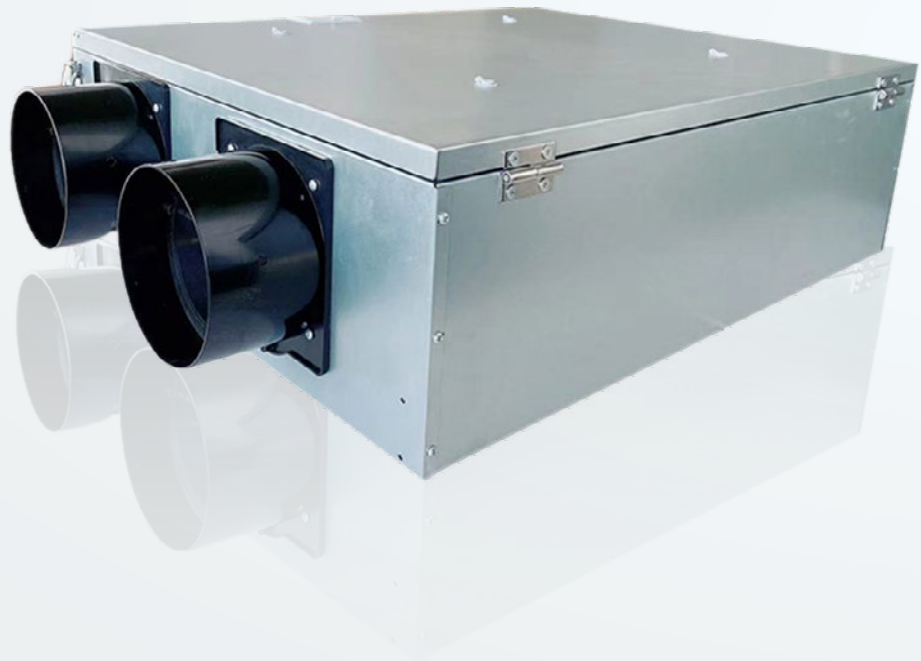

VENTILATION FANS

350

+718.338.1851

info@ammoelectric.com

www.ammoelectric.com

Ventilator Fan Plate Black





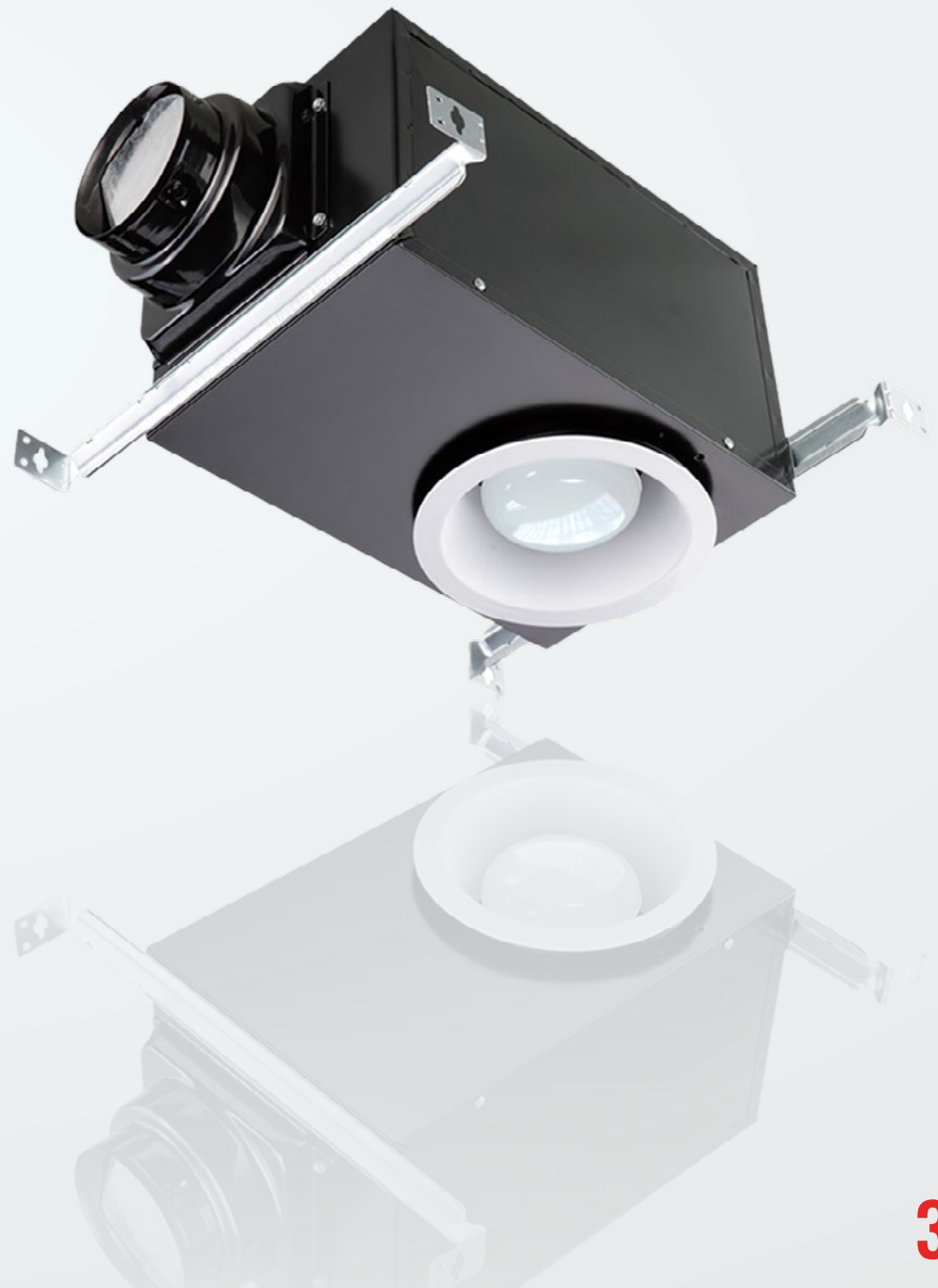

Steel plate Black & Plastic



AMMO#	SIZE	CFM	MOTOR	PKG
ARFSE80RVL	8 1/4" x 12 5/8" x 7 1/4"	80	AC Motor	1

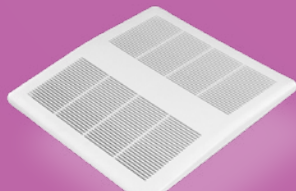

Fan Accessories

			
AMMO#	ARC02	ARC03	ARC04
DESCRIPTION	Grille For Ventilator Fan	Grille For Ventilator Fan	Grille For Ventilator Fan
SIZE	13"X13 3/4"	13"X13 3/4"	13"X13 3/4"
INNER	1	1	1
MASTER	15	5	15
			
AMMO#	ARC06	ARC10	ARC101
DESCRIPTION	Grille For Ventilator Fan	Grille For Ventilator Fan	Grille For Ventilator Fan
SIZE	13"X13"	13"X13 3/4"	13"X13 3/4"
INNER	1	1	1
MASTER	15	15	10

			
AMMO#	ARCL10	ARCL11	ARGV-01-SP
DESCRIPTION	Grille For Ventilator Fan	Grille For Ventilator Fan	Grille For Ventilator Fan
SIZE	13"X13 3/4"	13"X13"	8 3/4"X9 1/2"
INNER	1	1	1
MASTER	5	5	5
			
AMMO#	ARGV-BL06	ARGV-BL07	ARGV-B05
DESCRIPTION	Grille For Ventilator Fan	Grille For Ventilator Fan	Grille For Ventilator Fan
SIZE	Ø 13"	11 3/4"X11 3/4"	11 7/8"X11 3/8"
INNER	1	1	1
MASTER	5	5	15



Fire Damper Galvanized Steel



AMMO#	SIZE	INNER	MASTER
ARRDF2	10 3/8" x 9 7/8" x 3"	1	8



VENTILATION FANS

354

Fire Damper

Galvanized Steel



AMMO#	SIZE	INNER	MASTER
ARRDF3	12 1/4" x 11 1/4" x 3"	1	6





Index

AR110	10	AR187	18	AR781	24	AR53000	32
AR111	10	AR190	19	AR795	24	AR829	32
AR112	10	AR191	19	AR796	24	AR835	32
AR703	10	AR192	19	AR800	26	AR53075	32
AR292	11	AR197	20	AR801	26	AR53100	32
AR293	11	AR213	20	AR803	26	AR53125	32
AR125	12	AR218	20	AR808	26	AR53150	32
AR126	12	AR219	20	AR809	26	AR53200	32
AR127	12	AR220	20	AR810	26	AR920	34
AR128	12	AR223	20	AR811	26	AR922	34
AR129	12	AR224	20	AR812	26	ART24	34
AR130	12	AR225	20	AR813	26	AR512HD	34
AR145	12	AR227	20	AR814	26	AR925	34
AR146	12	AR228	20	AR902	26	ARBS16	35
AR150	12	AR229	20	AR906	26	ARBS24	35
AR152	12	AR201	22	AR907	28	AR23	35
AR4RB-MKO	12	AR202	22	AR915	28	ARTSRB	35
AR4RB-MKO-FB	12	AR203	22	AR4400	28	BHA-16	35
AR153	14	AR231	22	AR805	28	BHA-24	35
AR158	14	AR232	22	AR806	28	AR951	36
AR160	14	AR233	22	AR4433	28	AR952	36
AR155	14	AR242	22	AR245	29	AR953	36
AR157	14	AR244	22	AR247	29	AR954	36
AR161	14	AR4SDB-50	22	AR252	29	AR955	36
AR164	14	AR4SDB-50/75	22	AR259	29	AR956	36
AR324	14	AR4SDB-75/100	22	AR265	29	AR957	36
AR325	14	AR248	22	AR262	29	AR958	36
AR326	14	AR235	22	AR257	30	AR941	37
AR165	16	AR236	22	AR258	30	AR942	37
AR166	16	AR237	22	AR254	30	AR943	37
AR167	16	AR238	22	AR52000	31	AR944	37
AR175	16	AR240	22	AR52025	31	AR945	37
AR176	16	AR241	22	AR841	31	AR946	37
AR177	16	AR243	22	AR818	31	AR947	37
AR722	17	AR249	22	AR840	31	AR948	37
AR724	17	AR251	22	AR819	31	AR951-EXT	38
AR729	17	AR787	24	AR820	31	AR952-EXT	38
AR731	17	AR768	24	AR885	31	AR953-EXT	38
AR4RBC-MKO	17	AR771	24	AR52200	31	AR954-EXT	38
AR737	17	AR772	24	AR51000	31	AR955-EXT	38
AR727	17	AR773	24	AR51025	31	AR956-EXT	38
AR4R075	17	AR774	24	AR837	31	AR957-EXT	38
AR732	17	AR775	24	AR838	31	AR958-EXT	38
AR4R125	17	AR785	24	AR839	31	AR941-EXT	39
AR4R150	17	AR786	24	AR842	31	AR942-EXT	39
AR4R200	17	AR791	24	AR843	31	AR943-EXT	39
AR181	18	AR769	24	AR898	31	AR944-EXT	39
AR189	18	AR777	24	AR899	31	AR945-EXT	39
AR193	18	AR778	24	AR832	32	AR946-EXT	39
AR196	18	AR779	24	AR833	32	AR947-EXT	39
AR185	18	AR780	24	AR5BC-MKO	32	AR948-EXT	39

AR821-1/2	40	AR660	47	ARRW10050	62	ARB44AB	66
AR822-1/2	40	ARDHB-1-50/75	47	ARRW10075	62	ARB64A	66
AR823-1/2	40	AR663	47	ARRW12550	62	ARB53A	66
AR824-1/2	40	AR661	47	ARRW12575	62	ARB55A-UPC	66
AR825-1/2	40	AR662	47	ARRW125100	62	ARB525A	66
AR826-1/2	40	AR670	48	ARRW15050	62	ARB108R	67
AR827-1/2	40	AR674	48	ARRW15075	62	ARB120R	67
AR828-1/2	40	AR650	48	ARRW150100	62	ARB618R	67
AR821	40	AR653	48	ARRW150125	62	AR-PR1	68
AR822	40	AR860	49	ARRW20050	62	AR-PR2	68
AR823	40	AR861	49	ARRW20075	62	AR-PR3	68
AR824	40	AR862	49	ARRW200100	62	AR-PR4	68
AR825	40	AR865	49	ARRW200125	62	AR-PR5	68
AR826	40	AR864	49	ARRW200150	62	ARFSB50-3	72
AR827	40	AR863	49	ARRW25050	62	ARFSB50-3-W	72
AR828	40	AR867	49	ARRW25075	62	ARFSB50-4	72
AR821-5/8	40	AR404	50	ARRW250100	62	ARFSB50-4-W	72
AR822-5/8	40	AR405	50	ARRW250125	62	ARFSB50-5	72
AR823-5/8	40	AR400	51	ARRW250150	62	ARFSB50-5X	72
AR824-5/8	40	AR410	51	ARRW250200	62	ARFSB75-3	72
AR825-5/8	40	AR411	51	ARRW30050	62	ARFSB75-3-W	72
AR826-5/8	40	AR150-DSWB	51	ARRW30075	62	ARFSB75-4	72
AR827-5/8	40	AR420	52	ARRW300100	62	ARFSB75-4-W	72
AR828-5/8	40	AR440	52	ARRW300125	62	ARFSB75-5	72
AR821-1	40	AR445	52	ARRW300150	62	ARFSB75-5X	72
AR822-1	40	AR471	53	ARRW300200	62	ARFSB100-3	72
AR823-1	40	AR487	53	ARRW300250	62	ARDB50-3	74
AR824-1	40	AR523	54	ARRW35050	62	ARDB50-4	74
AR825-1	40	AR500	54	ARRW35075	62	ARDB50-5X	74
AR826-1	40	AR501	54	ARRW350100	62	ARDB75-3	74
AR827-1	40	AR503	54	ARRW350125	62	ARDB75-4	74
AR828-1	40	AR509	54	ARRW350150	62	ARDB75-5X	74
AR844	42	AR517	54	ARRW350200	62	ARDB100-3	74
AR845	42	AR518	54	ARRW350250	62	ARDB100-5X	74
AR846	42	AR519	54	ARRW350300	62	ARDBT50-5	75
AR847	42	AR524	54	ARRW40050	62	ARDBT75-5	75
AR848	42	AR531	54	ARRW40075	62	ARDBT100-5	75
AR849	42	AR504	54	ARRW400100	62	ARDBT50-7X	75
AR850	42	AR505	54	ARRW400125	62	ARDBT75-7X	75
AR851	42	AR502	54	ARRW400150	62	ARDBT100-7X	75
AR688	43	AR529	54	ARRW400200	62	ARTGB50-3	76
AR695	43	AR522	54	ARRW400250	62	ARTGB50-4	76
AR691	43	AR250-DEX	54	ARRW400300	62	ARTGB50-5	76
AR696	43	AR560	56	ARRW400350	62	ARTGB50-5X	76
AR692	43	AR561	56	ARDRS-50	63	ARTGB50-7	76
AR693	43	AR562	56	ARDRS-75	63	ARTGB50-7X	76
AR694	43	AR564	56	ARDRS-100	63	ARTGB50-9	76
AR960	43	AR565	56	ARSP-1	63	ARTGB75-3	76
AR686	44	AR567	56	ARSP-6	63	ARTGB75-4	76
AR687	44	AR570	56	ARSP-35	63	ARTGB75-5	76
ARY8MSB-5-FB	44	AR574	56	ARKO-50	64	ARTGB75-5X	76
AR270	45	AR590	58	ARKO-75	64	ARTGB75-7	76
AR271	45	AR591	58	ARKO-100	64	ARTGB75-7X	76
AR272	45	AR592	58	ARKO-125	64	ARTGB75-9	76
AR273	45	AR600	58	ARKO-150	64	ARTGB100-3	76
AR274	45	AR601	58	ARKO-200	64	ARTGB100-4	76
AR275	45	AR603	58	ARKOS-250	64	ARTGB100-5X	76
AR276	45	AR604	58	ARKOS-300	64	ARTS100	78
AR277	45	AR605	58	ARKOS-350	64	AR1C-DH	78
AR278	45	AR976	60	ARKOS-400	64	AR1C-DH-W	78
AR279	45	AR1BC	61	ARB18A	65	AR1C-DV	78
AR890	46	AR2BC	61	ARB22A-UPC	65	AR1C-DV-W	78
AR892	46	AR3BC	61	ARB32A-UPC	65	AR1C-GH	78
AR891	46	ARRBC-4	61	ARB20P-UPC	65	AR1C-GH-W	78
AR665	47	ARRW7550	62	ARB20A-UPC	65	AR1C-GV	78

AR1C-GV-W	78	ARSEC-75	86	150LT50UL	93	2-10-BLU-EMT	97
AR1C-SV	78	ARSEC-100	86	2LT50UL	93	2-1/2-10-BLU-EMT	97
AR1C-SV-W	78	ARSEC-125	86	FSC-50	94	3-10-BLU-EMT	97
AR1C-TS	78	ARSEC-150	86	FSC-75	94	3-1/2-10-BLU-EMT	97
AR1C-TS-W	78	ARSEC-200	86	FSC-100	94	4-10-BLU-EMT	97
AR1C-PO20	78	ARSEC-250	86	FSC-125	94	1/2-10-PURP-EMT	97
AR1C-PO30	78	ARSEC-300	86	FSC-150	94	3/4-10-PURP-EMT	97
AR1C-PO40	78	ARSEC-350	86	FSC-200	94	1-10-PURP-EMT	97
AR1C-SW	78	ARSEC-400	86	FSC-250	94	1-1/4-10-PURP-EMT	97
AR1C-SW-W	78	ARPVC-60	87	FSC-300	94	1-1/2-10-PURP-EMT	97
AR1CL-GV	78	ARPVC-62	87	FSC-350	94	2-10-PURP-EMT	97
ARG-1/G-2	78	ARSEMK-200	87	FSC-400	94	2-1/2-10-PURP-EMT	97
AR2C-SW	80	FSC-50UL	90	LTM-50	94	3-10-PURP-EMT	97
AR2C-SW-W	80	FSC-75UL	90	LTM-75	94	3-1/2-10-PURP-EMT	97
AR2C-2D	80	FSC-100UL	90	LTM-100	94	4-10-PURP-EMT	97
AR2C-DH	80	FSC-125UL	90	LTM-125	94	1/2-10-ORG-EMT	97
AR2C-2G	80	FSC-150UL	90	LTM-150	94	3/4-10-ORG-EMT	97
AR2C-GD	80	FSC-200UL	90	LTM-200	94	1-10-ORG-EMT	97
AR2C-2S	80	FSC-250UL	90	LTM-250	94	1-1/4-10-ORG-EMT	97
AR2C-GS	80	FSC-300UL	90	LTM-300	94	1-1/2-10-ORG-EMT	97
AR2C-SD	80	FSC-350UL	90	LTM-350	94	2-10-ORG-EMT	97
AR2C-PO50	80	FSC-400UL	90	LTM-400	94	2-1/2-10-ORG-EMT	97
AR2C-PO60	80	FLXAL250-38	91	1/2-10-EMT	95	3-10-ORG-EMT	97
AR3C-3D	80	FLXAL100-38	91	3/4-10-EMT	95	3-1/2-10-ORG-EMT	97
AR3C-3G	80	FLXAL100-50	91	1-10-EMT	95	4-10-ORG-EMT	97
AR3C-3S	80	FLXAL100-75	91	1-1/4-10-EMT	95	1/2-10-RSC	98
AR3RC-TS	80	FLXAL100-100	91	1-1/2-10-EMT	95	3/4-10-RSC	98
ARWIUP-1	81	FLXAL100-125	91	2-10-EMT	95	1-10-RSC	98
ARWIUP-1D	81	FLXAL100-150	91	2-1/2-10-EMT	95	1-1/4-10-RSC	98
ARWIUP-2D	81	FLXAL100-200	91	3-10-EMT	95	1-1/2-10-RSC	98
ARBRD-4	82	FLXAL100-250	91	3-1/2-10-EMT	95	2-10-RSC	98
ARBRD-4-W	82	FLXAL100-300	91	4-10-EMT	95	2-1/2-10-RSC	98
ARRB-7	82	FLXAL100-350	91	1/2-10-RD-EMT	96	3-10-RSC	98
AREXR50-4	82	FLXAL100-400	91	3/4-10-RD-EMT	96	3-1/2-10-RSC	98
AREXR75-4	82	FLXAL-38S	91	1-10-RD-EMT	96	4-10-RSC	98
ARLH150-5	83	FLXAL-50S	91	1-1/4-10-RD-EMT	96	5-10-RSC	98
ARRC-3+2LH150-5	83	FLXAL-75S	91	1-1/2-10-RD-EMT	96	6-10-RSC	98
AR-WPRLH	83	FLXAL-100S	91	2-10-RD-EMT	96	1/2-10-IMC	99
MSS1	83	FLXAL-125S	91	2-1/2-10-RD-EMT	96	3/4-10-IMC	99
ARXC-1	84	FLXAL-150S	91	3-10-RD-EMT	96	1-10-IMC	99
ARXC-2	84	FLXAL-200S	91	3-1/2-10-RD-EMT	96	1-1/4-10-IMC	99
ARRC-1	84	ARENT-50R	92	4-10-RD-EMT	96	1-1/2-10-IMC	99
ARRC-2	84	ARENT-75R	92	1/2-10-GN-EMT	96	2-10-IMC	99
ARRC-3	84	ARENT-100R	92	3/4-10-GN-EMT	96	2-1/2-10-IMC	99
ARRC-1-N	84	ARENT-125R	92	1-10-GN-EMT	96	3-10-IMC	99
ARRC-3-N	84	ARENT-150R	92	1-1/4-10-GN-EMT	96	3-1/2-10-IMC	99
ARRE-1	85	ARENT-200R	92	1-1/2-10-GN-EMT	96	4-10-IMC	99
ARRE-1-W	85	ARENT200F-50	92	2-10-GN-EMT	96	1/2-10-ALU	101
ARRE-2	85	ARENT100F-75	92	2-1/2-10-GN-EMT	96	3/4-10-ALU	101
ARRE-2-W	85	ARENT100F-100	92	3-10-GN-EMT	96	1-10-ALU	101
ARRE-3	85	LTM-50UL	93	3-1/2-10-GN-EMT	96	1-1/4-10-ALU	101
ARRE-3-W	85	LTM-75UL	93	4-10-GN-EMT	96	1-1/2-10-ALU	101
ARVPF001	85	LTM-100UL	93	1-10-Y-EMT	96	2-10-ALU	101
ARVPF002	85	LTM-125UL	93	1-1/4-10-Y-EMT	96	2-1/2-10-ALU	101
ARSET-50	86	LTM-150UL	93	1-1/2-10-Y-EMT	96	3-10-ALU	101
ARSET-75	86	LTM-200UL	93	2-10-Y-EMT	96	3-1/2-10-ALU	101
ARSET-100	86	LTM-250UL	93	2-1/2-10-Y-EMT	96	4-10-ALU	101
ARSET-125	86	LTM-300UL	93	3-10-Y-EMT	96	5-10-ALU	101
ARSET-150	86	LTM-350UL	93	3-1/2-10-Y-EMT	96	6-10-ALU	101
ARSET-200	86	LTM-400UL	93	4-10-Y-EMT	96	AREMT-12515	104
ARSET-250	86	38LT100UL	93	1/2-10-BLU-EMT	97	AREMT-15015	104
ARSET-300	86	12LT100UL	93	3/4-10-BLU-EMT	97	AREMT-20015	104
ARSET-350	86	34LT100UL	93	1-10-BLU-EMT	97	AREMT-25015	104
ARSET-400	86	1LT100UL	93	1-1/4-10-BLU-EMT	97	AREMT-30015	104
ARSEC-50	86	125LT50UL	93	1-1/2-10-BLU-EMT	97	AREMT-35015	104

AREMT-40015	104	ARRE-40045	107	ARCN-75200	111	ARCN-3001200	113
AREMT-12522	104	ARRE-5090	107	ARCN-75250	111	ARCN-400400	113
AREMT-15022	104	ARRE-7590	107	ARCN-75300	111	ARCN-400500	113
AREMT-20022	104	ARRE-10090	107	ARCN-75350	111	ARCN-400600	113
AREMT-25022	104	ARRE-12590	107	ARCN-75400	111	ARCN-400800	113
AREMT-30022	104	ARRE-15090	107	ARCN-75500	111	ARCN-4001000	113
AREMT-35022	104	ARRE-20090	107	ARCN-75600	111	ARCN-4001200	113
AREMT-40022	104	ARRE-25090	107	ARCN-75800	111	ARCN-350400	113
AREMT-12530	105	ARRE-30090	107	ARCN-751000	111	ARCN-350500	113
AREMT-15030	105	ARRE-35090	107	ARCN-751200	111	ARCN-350600	113
AREMT-20030	105	ARRE-40090	107	ARCN-100200	111	ARCN-350800	113
AREMT-25030	105	ARRE-50090	107	ARCN-100250	111	ARCN-3501000	113
AREMT-30030	105	ARRE-60090	107	ARCN-100300	111	ARCN-3501200	113
AREMT-35030	105	ARRE39036	107	ARCN-100350	111	ARRC-50	114
AREMT-40030	105	ARRE49036	107	ARCN-100400	111	ARRC-75	114
AREMT-5045	105	ARRE59036	107	ARCN-100500	111	ARRC-100	114
AREMT-7545	105	ARRE69036	107	ARCN-100600	111	ARRC-125	114
AREMT-10045	105	ARALU-12522	108	ARCN-100800	111	ARRC-150	114
AREMT-12545	105	ARALU-15022	108	ARCN-1001000	111	ARRC-200	114
AREMT-15045	105	ARALU-20022	108	ARCN-1001200	111	ARRC-250	114
AREMT-20045	105	ARALU-25022	108	ARCN-125200	111	ARRC-300	114
AREMT-25045	105	ARALU-30022	108	ARCN-125250	111	ARRC-350	114
AREMT-30045	105	ARALU-35022	108	ARCN-125300	111	ARRC-400	114
AREMT-35045	105	ARALU-40022	108	ARCN-125350	111	ARRC-500	114
AREMT-40045	105	ARALU-12530	108	ARCN-125400	111	ARRC-600	114
AREMT-5090	105	ARALU-15030	108	ARCN-125500	111	ARAC-50	115
AREMT-7590	105	ARALU-20030	108	ARCN-125600	111	ARAC-75	115
AREMT-10090	105	ARALU-25030	108	ARCN-125800	111	ARAC-100	115
AREMT-12590	105	ARALU-30030	108	ARCN-1251000	111	ARAC-125	115
AREMT-15090	105	ARALU-35030	108	ARCN-1251200	111	ARAC-150	115
AREMT-20090	105	ARALU-40030	108	ARCN-150200	112	ARAC-200	115
AREMT-25090	105	ARALU-5090	109	ARCN-150250	112	ARAC-250	115
AREMT-30090	105	ARALU-7590	109	ARCN-150300	112	ARAC-300	115
AREMT-35090	105	ARALU-10090	109	ARCN-150350	112	ARAC-350	115
AREMT-40090	105	ARALU-12590	109	ARCN-150400	112	ARAC-400	115
ARRE-12515	106	ARALU-15090	109	ARCN-150500	112	1/2-10-PVC-40	118
ARRE-15015	106	ARALU-20090	109	ARCN-150600	112	3/4-10-PVC-40	118
ARRE-20015	106	ARALU-25090	109	ARCN-150800	112	1-10-PVC-40	118
ARRE-25015	106	ARALU-30090	109	ARCN-1501000	112	1-1/4-10-PVC-40	118
ARRE-30015	106	ARALU-35090	109	ARCN-1501200	112	1-1/2-10-PVC-40	118
ARRE-35015	106	ARALU-40090	109	ARCN-200250	112	2-10-PVC-40	118
ARRE-40015	106	ARALU-50090	109	ARCN-200300	112	2-1/2-10-PVC-40	118
ARRE-12530	106	ARALU-60090	109	ARCN-200350	112	3-10-PVC-40	118
ARRE-15030	106	ARCN-50C	110	ARCN-200400	112	3-1/2-10-PVC-40	118
ARRE-20030	106	ARCN-75C	110	ARCN-200500	112	4-10-PVC-40	118
ARRE-25030	106	ARCN-100C	110	ARCN-200600	112	5-10-PVC-40	118
ARRE-30030	106	ARCN-125C	110	ARCN-200700	112	6-10-PVC-40	118
ARRE-35030	106	ARCN-150C	110	ARCN-200800	112	8-10-PVC-40*	118
ARRE-40030	106	ARCN-200C	110	ARCN-2001000	112	1/2-10-PVC-80	118
ARRE-12522	106	ARCN-250C	110	ARCN-2001200	112	3/4-10-PVC-80	118
ARRE-15022	106	ARCN-300C	110	ARCN-250300	112	1-10-PVC-80	118
ARRE-20022	106	ARCN-350C	110	ARCN-250350	112	1-1/4-10-PVC-80	118
ARRE-25022	106	ARCN-400C	110	ARCN-250400	112	1-1/2-10-PVC-80	118
ARRE-30022	106	ARCN-50150	110	ARCN-250500	112	2-10-PVC-80	118
ARRE-35022	106	ARCN-50200	110	ARCN-250600	112	2-1/2-10-PVC-80	118
ARRE-40022	106	ARCN-50250	110	ARCN-250800	112	3-10-PVC-80	118
ARRE-5045	107	ARCN-50300	110	ARCN-2501000	112	3-1/2-10-PVC-80	118
ARRE-7545	107	ARCN-50350	110	ARCN-2501200	112	4-10-PVC-80	118
ARRE-10045	107	ARCN-50400	110	ARCN-300300	113	5-10-PVC-80	118
ARRE-12545	107	ARCN-50500	110	ARCN-300350	113	6-10-PVC-80	118
ARRE-15045	107	ARCN-50600	110	ARCN-300400	113	8-10-PVC-80*	118
ARRE-20045	107	ARCN-50800	110	ARCN-300500	113	1/2-20-PVC-40	119
ARRE-25045	107	ARCN-501000	110	ARCN-300600	113	3/4-20-PVC-40	119
ARRE-30045	107	ARCN-501200	110	ARCN-300800	113	1-20-PVC-40	119
ARRE-35045	107	ARCN-75150	111	ARCN-3001000	113	1-1/4-20-PVC-40	119

1-1/2-20-PVC-40	119	ARP40B-5045	122	ARP80P-5090	125	AREXP40PVC-300	127
2-20-PVC-40	119	ARP40B-7545	122	ARP80P-7590	125	AREXP40PVC-350	127
2-1/2-20-PVC-40	119	ARP40B-10045	122	ARP80P-10090	125	AREXP40PVC-400	127
3-20-PVC-40	119	ARP40B-12545	122	ARP80P-12590	125	ARCPVC40-50	127
3-1/2-20-PVC-40	119	ARP40B-15045	122	ARP80P-15090	125	ARCPVC40-75	127
4-20-PVC-40	119	ARP40B-20045	122	ARP80P-20090	125	ARCPVC40-100	127
5-20-PVC-40	119	ARP40B-25045	122	ARP80P-25090	125	ARCPVC40-125	127
6-20-PVC-40	119	ARP40B-30045	122	ARP80P-30090	125	ARCPVC40-150	127
8-20-PVC-40*	119	ARP40B-35045	122	ARP80P-35090	125	ARCPVC40-200	127
DB60-5-20-PVC	119	ARP40B-40045	122	ARP80P-40090	125	ARCPVC40-250	127
1/2-20-PVC-80	119	ARP40B-50045	122	ARP80P-50090	125	ARCPVC40-300	127
3/4-20-PVC-80	119	ARP40B-60045	122	ARP80P-60090	125	ARCPVC40-350	127
1-20-PVC-80	119	*ARP40B-80045	122	*ARP80P-80090	125	ARCPVC40-400	127
1-1/4-20-PVC-80	119	ARP40P-5090	123	ARP80B-5090	125	ARCPVC40-500	127
1-1/2-20-PVC-80	119	ARP40P-7590	123	ARP80B-7590	125	ARCPVC40-600	127
2-20-PVC-80	119	ARP40P-10090	123	ARP80B-10090	125	AR40PVC-7550	128
2-1/2-20-PVC-80	119	ARP40P-12590	123	ARP80B-12590	125	AR40PVC-10075	128
3-20-PVC-80	119	ARP40P-15090	123	ARP80B-15090	125	AR40PVC-125100	128
3-1/2-20-PVC-80	119	ARP40P-20090	123	ARP80B-20090	125	AR40PVC-150125	128
4-20-PVC-80	119	ARP40P-25090	123	ARP80B-25090	125	AR40PVC-200150	128
5-20-PVC-80	119	ARP40P-30090	123	ARP80B-30090	125	AR40PVC-250200	128
6-20-PVC-80	119	ARP40P-35090	123	ARP80B-35090	125	AR40PVC-300200	128
8-20-PVC-80*	119	ARP40P-40090	123	ARP80B-40090	125	AR40PVC-300250	128
ARLBPVC-50	120	ARP40P-50090	123	ARP80B-50090	125	AR40PVC-350300	128
ARLBPVC-75	120	ARP40P-60090	123	ARP80B-60090	125	AR40PVC-400300	128
ARLBPVC-100	120	*ARP40P-80090	123	*ARP80B-80090	125	AR40PVC-400350	128
ARLBPVC-125	120	ARP40B-5090	123	ARTA40PVC-50	126	ARBXPVC-50	128
ARLBPVC-150	120	ARP40B-7590	123	ARTA40PVC-75	126	ARBXPVC-75	128
ARLBPVC-200	120	ARP40B-10090	123	ARTA40PVC-100	126	ARBXPVC-100	128
ARLBPVC-250	120	ARP40B-12590	123	ARTA40PVC-125	126	ARBXPVC-125	128
ARLBPVC-300	120	ARP40B-15090	123	ARTA40PVC-150	126	ARBXPVC-150	128
ARLLPVC-50	120	ARP40B-20090	123	ARTA40PVC-200	126	ARBXPVC-200	128
ARLLPVC-75	120	ARP40B-25090	123	ARTA40PVC-250	126	ARBXPVC-250	128
ARLLPVC-100	120	ARP40B-30090	123	ARTA40PVC-300	126	ARBXPVC-300	128
ARLLPVC-125	120	ARP40B-35090	123	ARFA40PVC-50	126	ARBXPVC-350	128
ARLLPVC-150	120	ARP40B-40090	123	ARFA40PVC-75	126	ARBXPVC-400	128
ARLLPVC-200	120	ARP40B-50090	123	ARFA40PVC-100	126	ARMTA-50-PVC	129
ARLRPVC-50	120	ARP40B-60090	123	ARFA40PVC-125	126	ARMTA-75-PVC	129
ARLRPVC-75	120	*ARP40B-80090	123	ARFA40PVC-150	126	ARMTA-100-PVC	129
ARLRPVC-100	120	ARP80P-5045	124	ARFA40PVC-200	126	ARMTA-125-PVC	129
ARLRPVC-125	120	ARP80P-7545	124	ARFA40PVC-250	126	ARMTA-150-PVC	129
ARLRPVC-150	120	ARP80P-10045	124	ARFA40PVC-300	126	ARMTA-200-PVC	129
ARLRPVC-200	120	ARP80P-12545	124	ARFA40PVC-350	126	*ARMTA-250-PVC	129
ARCB-50-PVC	121	ARP80P-15045	124	ARFA40PVC-400	126	*ARMTA-300-PVC	129
ARCB-75-PVC	121	ARP80P-20045	124	ARFA40PVC-500	126	*ARMTA-400-PVC	129
ARCB-100-PVC	121	ARP80P-25045	124	ARFA40PVC-600	126	AROF40PVC-50	129
ARTPVC-50	121	ARP80P-30045	124	AREND40PVC-50	127	AROF40PVC-75	129
ARTPVC-75	121	ARP80P-35045	124	AREND40PVC-75	127	ARTHSPVC-50	129
ARTPVC-100	121	ARP80P-40045	124	AREND40PVC-100	127	ARTHSPVC-75	129
ARTPVC-125	121	ARP80P-50045	124	AREND40PVC-125	127	ARTHSPVC-100	129
ARTPVC-150	121	ARP80P-60045	124	AREND40PVC-150	127	ARTHSPVC-125	129
ARTPVC-200	121	*ARP80P-80045	124	AREND40PVC-200	127	ARTHSPVC-150	129
ARP40P-5045	122	ARP80B-5045	124	AREND40PVC-250	127	ARTHSPVC-200	129
ARP40P-7545	122	ARP80B-7545	124	AREND40PVC-300	127	ARTHSPVC-250	129
ARP40P-10045	122	ARP80B-10045	124	AREND40PVC-350	127	ARTHSPVC-300	129
ARP40P-12545	122	ARP80B-12545	124	AREND40PVC-400	127	ARTHSPVC-350	129
ARP40P-15045	122	ARP80B-15045	124	AREND40PVC-500	127	ARTHSPVC-400	129
ARP40P-20045	122	ARP80B-20045	124	AREND40PVC-600	127	AROFPVC40-125	130
ARP40P-25045	122	ARP80B-25045	124	AREXP40PVC-50	127	AROFPVC40-200	130
ARP40P-30045	122	ARP80B-30045	124	AREXP40PVC-75	127	ARSPVC-125	130
ARP40P-35045	122	ARP80B-35045	124	AREXP40PVC-100	127	ARSPVC-150	130
ARP40P-40045	122	ARP80B-40045	124	AREXP40PVC-125	127	ARSPVC-200	130
ARP40P-50045	122	ARP80B-50045	124	AREXP40PVC-150	127	ARSPVC-250	130
ARP40P-60045	122	ARP80B-60045	124	AREXP40PVC-200	127	AREPE40PVC-75	131
*ARP40P-80045	122	*ARP80B-80045	124	AREXP40PVC-250	127	ARLB-50CF	134

ARLB-75CF	134	ARMGLLR-100MI	137	ARLLE-75CF	140	ARLL-100MI	142
ARLB-100CF	134	ARMGLLR-125MI	137	ARLLE-100CF	140	ARLL-125MI	142
ARLB-125CF	134	ARMGLLR-150MI	137	ARLLE-125CF	140	ARLL-150MI	142
ARLB-150CF	134	ARMGLLR-200MI	137	ARLLE-150CF	140	ARLL-200MI	142
ARLB-200CF	134	ARMGLLR-250MI	137	ARLLE-200CF	140	ARLL-250MI	142
ARLB-250CF	134	ARMGLLR-300MI	137	ARLLE-250CF	140	ARLL-300MI	142
ARLB-300CF	134	ARMGLLR-350MI	137	ARLLE-300CF	140	ARLL-350MI	142
ARLB-350CF	134	ARMGLLR-400MI	137	ARLLE-350CF	140	ARLL-400MI	142
ARLB-400CF	134	ARMGTR-100MI	137	ARLLE-400CF	140	ARLR-50MI	143
ARLL-50CF	134	ARMGTR-125MI	137	ARLRE-50CF	140	ARLR-75MI	143
ARLL-75CF	134	ARMGTR-150MI	137	ARLRE-75CF	140	ARLR-100MI	143
ARLL-100CF	134	ARMGTR-200MI	137	ARLRE-100CF	140	ARLR-125MI	143
ARLL-125CF	134	ARMGTR-250MI	137	ARLRE-125CF	140	ARLR-150MI	143
ARLL-150CF	134	ARMGTR-300MI	137	ARLRE-150CF	140	ARLR-200MI	143
ARLL-200CF	134	ARMGTR-350MI	137	ARLRE-200CF	140	ARLR-250MI	143
ARLL-250CF	134	ARMGTR-400MI	137	ARLRE-250CF	140	ARLR-300MI	143
ARLL-300CF	134	ARMGLRR-100MI	137	ARLRE-300CF	140	ARLR-350MI	143
ARLL-350CF	134	ARMGLRR-125MI	137	ARLRE-350CF	140	ARLR-400MI	143
ARLL-400CF	134	ARMGLRR-150MI	137	ARLRE-400CF	140	ARCG-50MI	143
ARLR-50CF	135	ARMGLRR-200MI	137	ARCE-50CF	141	ARCG-75MI	143
ARLR-75CF	135	ARMGLRR-250MI	137	ARCE-75CF	141	ARCG-100MI	143
ARLR-100CF	135	ARMGLRR-300MI	137	ARCE-100CF	141	ARCG-125/150MI	143
ARLR-125CF	135	ARMGLRR-350MI	137	ARCE-125CF	141	ARCG-200MI	143
ARLR-150CF	135	ARMGLRR-400MI	137	ARCE-150CF	141	ARCG-250/300MI	143
ARLR-200CF	135	ARLBC-50CF	138	ARCE-200CF	141	ARCG-350/400MI	143
ARLR-250CF	135	ARLBC-75CF	138	ARCE-250CF	141	ARC-50MI	143
ARLR-300CF	135	ARLBC-100CF	138	ARCE-300CF	141	ARC-75MI	143
ARLR-350CF	135	ARLBC-125CF	138	ARCE-350CF	141	ARC-100MI	143
ARLR-400CF	135	ARLBC-150CF	138	ARCE-400CF	141	ARC-125MI	143
ARC-50CF	135	ARLBC-200CF	138	ARCF-50	141	ARC-150MI	143
ARC-75CF	135	ARLLC-50CF	138	ARCF-75	141	ARC-200MI	143
ARC-100CF	135	ARLLC-75CF	138	ARCF-100	141	ARC-250MI	143
ARC-125CF	135	ARLLC-100CF	138	ARCF-125/150	141	ARC-300MI	143
ARC-150CF	135	ARLLC-125CF	138	ARCF-200	141	ARC-350MI	143
ARC-200CF	135	ARLLC-150CF	138	ARCF-250/300	141	ARC-400MI	143
ARC-250CF	135	ARLLC-200CF	138	ARCF-350/400	141	ART-50MI	143
ARC-300CF	135	ARLRC-50CF	139	ARTE-50CF	141	ART-75MI	143
ARC-350CF	135	ARLRC-75CF	139	ARTE-75CF	141	ART-100MI	143
ARC-400CF	135	ARLRC-100CF	139	ARTE-100CF	141	ART-125MI	143
ART-50CF	135	ARLRC-125CF	139	ARTE-125CF	141	ART-150MI	143
ART-75CF	135	ARLRC-150CF	139	ARTE-150CF	141	ART-200MI	143
ART-100CF	135	ARLRC-200CF	139	ARTE-200CF	141	ART-250MI	143
ART-125CF	135	ARTC-50CF	139	ARTE-250CF	141	ART-300MI	143
ART-150CF	135	ARTC-75CF	139	ARTE-300CF	141	ART-350MI	143
ART-200CF	135	ARTC-100CF	139	ARTE-350CF	141	ART-400MI	143
ART-250CF	135	ARTC-125CF	139	ARTE-400CF	141	ARRLB-50G7	144
ART-300CF	135	ARTC-150CF	139	ARSGN-50	141	ARRLB-75G7	144
ART-350CF	135	ARTC-200CF	139	ARSGN-75	141	ARRLB-100G7	144
ART-400CF	135	ARCC-50CF	139	ARSGN-100	141	ARRLB-125G7	144
ARMGLBR-100MI	136	ARCC-75CF	139	ARSGN-125/150	141	ARRLB-150G7	144
ARMGLBR-125MI	136	ARCC-100CF	139	ARSGN-200	141	ARRLB-200G7	144
ARMGLBR-150MI	136	ARCC-125CF	139	ARSGN-250/300	141	ARRLB-250G7	144
ARMGLBR-200MI	136	ARCC-150CF	139	ARSGN-350/400	141	ARRLB-300G7	144
ARMGLBR-250MI	136	ARCC-200CF	139	ARLB-50MI	142	ARRLB-350G7	144
ARMGLBR-300MI	136	ARLBE-50CF	140	ARLB-75MI	142	ARRLB-400G7	144
ARMGLBR-350MI	136	ARLBE-75CF	140	ARLB-100MI	142	ARRLL-50G7	144
ARMGLBR-400MI	136	ARLBE-100CF	140	ARLB-125MI	142	ARRLL-75G7	144
ARMGCR-100MI	136	ARLBE-125CF	140	ARLB-150MI	142	ARRLL-100G7	144
ARMGCR-125MI	136	ARLBE-150CF	140	ARLB-200MI	142	ARRLL-125G7	144
ARMGCR-150MI	136	ARLBE-200CF	140	ARLB-250MI	142	ARRLL-150G7	144
ARMGCR-200MI	136	ARLBE-250CF	140	ARLB-300MI	142	ARRLL-200G7	144
ARMGCR-250MI	136	ARLBE-300CF	140	ARLB-350MI	142	ARRLL-250G7	144
ARMGCR-300MI	136	ARLBE-350CF	140	ARLB-400MI	142	ARRLL-300G7	144
ARMGCR-350MI	136	ARLBE-400CF	140	ARLL-50MI	142	ARRLL-350G7	144
ARMGCR-400MI	136	ARLLE-50CF	140	ARLL-75MI	142	ARRLL-400G7	144

ARRLR-50G7	144	ARSCNS-75	150	ARSCPZ-125	153	ARCCPZ-350	156
ARRLR-75G7	144	ARSCNS-100	150	ARSCPZ-150	153	ARCCPZ-400	156
ARRLR-100G7	144	ARSCNS-125	150	ARSCPZ-200	153	ARCCNRS-50	157
ARRLR-125G7	144	ARSCNS-150	150	ARSCPZ-250	153	ARCCNRS-75	157
ARRLR-150G7	144	ARSCNS-200	150	ARSCPZ-300	153	ARCCNRS-100	157
ARRLR-200G7	144	ARSCNS-250	150	ARSCPZ-350	153	ARCCNRS-125	157
ARRLR-250G7	144	ARSCNS-300	150	ARSCPZ-400	153	ARCCNRS-150	157
ARRLR-300G7	144	ARSCNS-350	150	ARCCNS-50	154	ARCCNRS-200	157
ARRLR-350G7	144	ARSCNS-400	150	ARCCNS-75	154	ARCCNRS-250	157
ARRLR-400G7	144	ARSCNS-50I	150	ARCCNS-100	154	ARCCNRS-300	157
ARRLC-50G7	145	ARSCNS-75I	150	ARCCNS-125	154	ARCCNRS-350	157
ARRLC-75G7	145	ARSCNS-100I	150	ARCCNS-150	154	ARCCNRS-400	157
ARRLC-100G7	145	ARSCNS-125I	150	ARCCNS-200	154	ARCCNRS-50I	157
ARRLC-125G7	145	ARSCNS-150I	150	ARCCNS-250	154	ARCCNRS-75I	157
ARRLC-150G7	145	ARSCNS-200I	150	ARCCNS-300	154	ARCCNRS-100I	157
ARRLC-200G7	145	ARSCNS-250I	150	ARCCNS-350	154	ARCCNRS-125I	157
ARRLC-250G7	145	ARSCNS-300I	150	ARCCNS-400	154	ARCCNRS-150I	157
ARRLC-300G7	145	ARSCNS-350I	150	ARCCNS-50I	154	ARCCNRS-200I	157
ARRLC-350G7	145	ARSCNS-400I	150	ARCCNS-75I	154	ARCCNRS-250I	157
ARRLC-400G7	145	ARSCNZ-50	151	ARCCNS-100I	154	ARCCNRS-300I	157
ARRLT-50G7	145	ARSCNZ-75	151	ARCCNS-125I	154	ARCCNRS-350I	157
ARRLT-75G7	145	ARSCNZ-100	151	ARCCNS-150I	154	ARCCNRS-400I	157
ARRLT-100G7	145	ARSCNZ-125	151	ARCCNS-200I	154	ARCCPRS-50	157
ARRLT-125G7	145	ARSCNZ-150	151	ARCCNS-250I	154	ARCCPRS-75	157
ARRLT-150G7	145	ARSCNZ-200	151	ARCCNS-300I	154	ARCCPRS-100	157
ARRLT-200G7	145	ARSCNZ-250	151	ARCCNS-350I	154	ARCCPRS-125	157
ARRLT-250G7	145	ARSCNZ-300	151	ARCCNS-400I	154	ARCCPRS-150	157
ARRLT-300G7	145	ARSCNZ-350	151	ARCCNZ-50	155	ARCCPRS-200	157
ARRLT-350G7	145	ARSCNZ-400	151	ARCCNZ-75	155	ARCCPRS-250	157
ARRLT-400G7	145	ARSCNZ-50I	151	ARCCNZ-100	155	ARCCPRS-300	157
ARCBC-50GLT	146	ARSCNZ-75I	151	ARCCNZ-125	155	ARCCPRS-350	157
ARCBC-75GLT	146	ARSCNZ-100I	151	ARCCNZ-150	155	ARCCPRS-400	157
ARCBC-100GLT	146	ARSCNZ-125I	151	ARCCNZ-200	155	ARCPSNM-5038	158
ARCBC-125GLT	146	ARSCNZ-150I	151	ARCCNZ-250	155	ARSCPSCB-38	158
ARCBC-150GLT	146	ARSCNZ-200I	151	ARCCNZ-300	155	ARSCPSCB-50	158
ARCBC-200GLT	146	ARSCNZ-250I	151	ARCCNZ-350	155	ARSCPSCB-75	158
ARCBC-250/300GLT	146	ARSCNZ-300I	151	ARCCNZ-400	155	ARSCPSCB-38F	158
ARCBC-350/400GLT	146	ARSCNZ-350I	151	ARCCNZ-50I	155	ARSCPSCB-50F	158
ARCBC-50S	146	ARSCNZ-400I	151	ARCCNZ-75I	155	ARSCPSCB-75F	158
ARCBC-75S	146	ARSL50G	152	ARCCNZ-100	155	ARSTERZ-50	159
ARCBC-100S	146	ARSL75G	152	ARCCNZ-125I	155	ARSTERZ-75	159
ARCBC-125S	146	ARSL100G	152	ARCCNZ-150I	155	ARSTERZ-100	159
ARCBC-150S	146	ARSL125G	152	ARCCNZ-200I	155	ARSTERZ-125	159
ARCBC-200S	146	ARSL150G	152	ARCCNZ-250I	155	ARSTEBZ-50	159
ARCBC-250/300S	146	ARSL200G	152	ARCCNZ-300I	155	ARSTEBZ-75	159
ARCBC-350/400S	146	ARSL250G	152	ARCCNZ-350I	155	ARPECO-50	159
ARMHDG-50MI	147	ARSL300G	152	ARCCNZ-400I	155	ARPECO-75	159
ARMHDG-75MI	147	ARSL350G	152	ARCCPS-50	156	ARPECO-100	159
ARMHDG-100MI	147	ARSL400G	152	ARCCPS-75	156	ARCCNS90-50	160
ARMHDG-125/150MI	147	ARCCSR-50	152	ARCCPS-100	156	ARCCNS90-75	160
ARMHDG-200MI	147	ARCCSR-75	152	ARCCPS-125	156	ARCCNS90-100	160
ARMHDG-250/300MI	147	ARCCSR-100	152	ARCCPS-150	156	ARSSINCOR-50	160
ARMHDG-350/400MI	147	ARSCPS-50	153	ARCCPS-200	156	ARSSINCOR-75	160
ARLB-300MI	147	ARSCPS-75	153	ARCCPS-250	156	ARCPZC-50	160
ARLB-350MI	147	ARSCPS-100	153	ARCCPS-300	156	ARCPZC-75	160
ARLB-400MI	147	ARSCPS-125	153	ARCCPS-350	156	ARCELT-50	161
ARCBC-50G	147	ARSCPS-150	153	ARCCPS-400	156	ARCELT-75	161
ARCBC-75G	147	ARSCPS-200	153	ARCCPZ-50	156	ARCELT-100	161
ARCBC-100G	147	ARSCPS-250	153	ARCCPZ-75	156	ARCER-50	161
ARCBC-125G	147	ARSCPS-300	153	ARCCPZ-100	156	ARCER-75	161
ARCBC-150G	147	ARSCPS-350	153	ARCCPZ-125	156	ARCER-100	161
ARCBC-200G	147	ARSCPS-400	153	ARCCPZ-150	156	ARBX-38	162
ARCBC-250/300G	147	ARSCPZ-50	153	ARCCPZ-200	156	ARFDS-38	162
ARCBC-350/400G	147	ARSCPZ-75	153	ARCCPZ-250	156	ARDC3890	162
ARSCNS-50	150	ARSCPZ-100	153	ARCCPZ-300	156	ARSSBXZ-5038	162

ARSCBF-38MI	162	ARFCSQ90-50IT	167	AR-1008B	172	ARBNSLT90-150	179
AR-38AST	162	ARFCSQ90-75IT	167	AR3838AST	172	ARBNSLT90-200	179
ARBXFC-3845	162	ARFCSQ90-100IT	167	ARFLEXC-50	174	ARLTGN-50	180
ARSCBF-38ZC	162	ARFCSQ90-125IT	167	ARFLEXC-75	174	ARLTGN-75	180
ARMC-50	164	ARFCSQ90-150IT	167	ARFLEXC-100	174	ARLTGN-100	180
ARFSC-38	164	ARFCSQ90-200IT	167	ARFLEXC-125	174	ARLTGN-125	180
ARSG-3838	164	ARFCN90-38	168	ARFLEXC-150	174	ARLTGN-150	180
ARMCD-50	164	ARFCN90-50	168	ARFLEXC-200	174	ARLTGN-200	180
ARFSS-38	164	ARFCN90-75	168	ARBFCS-38	174	ARLTGN-250	180
ARMCN-38	164	ARFCN90-100	168	ARBFCS-50	174	ARLTGN-300	180
ARMCN-50	164	ARFCN90-125	168	ARBFCS-75	174	ARLTGN-350	180
ARMCN-75	164	ARFCN90-150	168	ARBFCS-100	174	ARLTGN-400	180
ARTBSC-38I	165	ARFCN90-200	168	ARBFCS-125	174	ARLTGN90-50	180
ARTBSC-50I	165	ARFCN90-250	168	ARBFCS-150	174	ARLTGN90-75	180
ARTBSC-75I	165	ARFCN90-300	168	ARBFCS-200	174	ARLTGN90-100	180
ARTBSC-100I	165	ARFCN90-350	168	ARNMCN-50	175	ARLTGN90-125	180
ARTBSC-125I	165	ARFCN90-400	168	ARNMCN-75	175	ARLTGN90-150	180
ARTBSC-150I	165	ARDC-3890MI	168	ARNMCN-100	175	ARLTGN90-200	180
ARTBSC-200I	165	ARDC-5090MI	168	ARNMCN-125	175	ARLTGN90-250	180
ARTBSC-250I	165	ARDC-7590MI	168	ARNMCN-150	175	ARLTGN90-300	180
ARTBSC-300I	165	ARDC-10090MI	168	ARNMCN-200	175	ARLTGN90-350	180
ARTBSC-350I	165	ARDC-12590MI	168	ARTA911	175	ARLTGN90-400	180
ARTBSC-400I	165	ARDC-15090MI	168	ARTA912	175	ARLTGN-38I	181
ARFCNS-38	165	ARDC-20090MI	168	ARTA913	175	ARLTGN-50I	181
ARFCNS-50	165	ARDC-25090MI	168	ARTA914	175	ARLTGN-75I	181
ARFCNS-75	165	ARDC-30090MI	168	ARTA915	175	ARLTGN-100I	181
ARFCNS-100	165	ARDC-35090MI	168	ARTA916	175	ARLTGN-125I	181
ARFCNS-125	165	ARDC-40090MI	168	ARSCCTF-50	176	ARLTGN-150I	181
ARFCNS-150	165	ARDCI-5090MI	169	ARSCCTF-75	176	ARLTGN-200I	181
ARFCNS-200	165	ARDCI-7590MI	169	ARSCCTF-100	176	ARLTGN90-50I	181
ARFCNS-250	165	ARDCI-10090MI	169	ARSCTF-50	176	ARLTGN90-75I	181
ARFCNS-300	165	ARDCI-12590MI	169	ARSCTF-75	176	ARLTGN90-100I	181
ARFCNS-350	165	ARDCI-15090MI	169	ARSCTF-100	176	ARLTGN90-125I	181
ARFCNS-400	165	ARDCI-20090MI	169	ARUSB	177	ARLTGN90-150I	181
ARCR50	165	ARDCI-25090MI	169	ARNMSC-50	177	ARLTGN90-200I	181
ARCR75	165	ARDCI-30090MI	169	ARNMSCT-50	177	ARLTGN-38MI	182
ARFCNS-50I	166	ARDCI-35090MI	169	ARNMSCT-75	177	ARLTGN-50MI	182
ARFCNS-75I	166	ARDCI-40090MI	169	ARA0	177	ARLTGN-75MI	182
ARFCNS-100I	166	ARFDS90-38	169	ARA1	177	ARLTGN-100MI	182
ARFCNS-125I	166	ARFDS90-38Z	170	38LTNM-SC	178	ARLTGN-125MI	182
ARFCNS-150I	166	ARDDSL90-38	170	50LTNM-SC	178	ARLTGN-150MI	182
ARFCNS-200I	166	ARDDSL90-50	170	75LTNM-SC	178	ARLTGN-200MI	182
ARFCNS-38MI	166	ARDBTSC45-38I	171	100LTNM-SC	178	ARLTGN-250MI	182
ARFCNS-50MI	166	ARDBTSC45-50I	171	125LTNM-SC	178	ARLTGN-300MI	182
ARFCNS-75MI	166	ARDBTSC45-75I	171	150LTNM-SC	178	ARLTGN-350MI	182
ARFCNS-100MI	166	ARDTB90-38I	171	200LTNM-SC	178	ARLTGN-400MI	182
ARFCNS-125MI	166	ARDTB90-50I	171	38-90LTNM	178	ARLTGN45-38MI	182
ARFCNS-150MI	166	ARDTB90-75I	171	50-90LTNM	178	ARLTGN45-50MI	182
ARFCNS-200MI	166	ARDTB90-100I	171	75-90LTNM	178	ARLTGN45-75MI	182
ARFCNS-250MI	166	ARBFCS-38IT	171	100-90LTNM	178	ARLTGN45-100MI	182
ARFCNS-300MI	166	ARBFCS-50IT	171	125-90LTNM	178	ARLTGN45-125MI	182
ARFCNS-350MI	166	ARBFCS-75IT	171	150-90LTNM	178	ARLTGN45-150MI	182
ARFCNS-400MI	166	ARBFCS-100IT	171	200-90LTNM	178	ARLTGN45-200MI	182
ARFCNS-38TMI	167	ARBFCS-125IT	171	ARBNSLT-38	179	ARLTGN45-250MI	182
ARFCNS-50TMI	167	ARBFCS-150IT	171	ARBNSLT-50	179	ARLTGN45-300MI	182
ARFCNS-75TMI	167	ARBFCS-200IT	171	ARBNSLT-75	179	ARLTGN45-350MI	182
ARFCNS-100TMI	167	AR-1001	172	ARBNSLT-100	179	ARLTGN45-400MI	182
ARFCNS-125TMI	167	AR-1002	172	ARBNSLT-125	179	ARLTGN90-38MI	183
ARFCNS-150TMI	167	AR-1003	172	ARBNSLT-150	179	ARLTGN90-50MI	183
ARFCNS-200TMI	167	AR-1004A	172	ARBNSLT-200	179	ARLTGN90-75MI	183
ARFCNS-250TMI	167	AR-1005A	172	ARBNSLT90-38	179	ARLTGN90-100MI	183
ARFCNS-300TMI	167	AR-1005B	172	ARBNSLT90-50	179	ARLTGN90-125MI	183
ARFCNS-350TMI	167	AR-1006	172	ARBNSLT90-75	179	ARLTGN90-150MI	183
ARFCNS-400TMI	167	AR-1007A	172	ARBNSLT90-100	179	ARLTGN90-200MI	183
ARFCSQ90-38IT	167	AR-1008A	172	ARBNSLT90-125	179	ARLTGN90-250MI	183

ARLTCN90-300MI	183	ARRP06	186	ARGB-100I	190	ARBB-50I	193
ARLTCN90-350MI	183	ARRP07	186	ARGB-125I	190	ARBB-75I	193
ARLTCN90-400MI	183	ARRP08	186	ARGB-150I	190	ARBB-100I	193
ARLTGN-38MI	183	ARRP09	186	ARGB-200I	190	ARBB-125I	193
ARLTGN-50MI	183	ARRP10	186	ARGB-250I	190	ARBB-150I	193
ARLTGN-75MI	183	ARRTC01	187	ARGB-300I	190	ARBB-200I	193
ARLTGN-100MI	183	ARRTC02	187	ARGB-350I	190	ARBB-250I	193
ARLTGN-125MI	183	ARRTC03	187	ARGB-400I	190	ARBB-300I	193
ARLTGN-150MI	183	ARRTC04	187	ARGBU-50MHDG	190	ARBB-350I	193
ARLTGN-200MI	183	ARRTC05	187	ARGBU-75MHDG	190	ARBB-400I	193
ARLTGN-250MI	183	ARRTC06	187	ARGBU-100MHDG	190	ARBB01	193
ARLTGN-300MI	183	ARRTP01	187	ARGBU-125MHDG	190	ARBB02	193
ARLTGN-350MI	183	ARRTP02	187	ARGBU-150MHDG	190	ARBB03	193
ARLTGN-400MI	183	ARRTP03	187	ARGBU-200MHDG	190	ARBB04	193
ARLTGN45-38MI	184	ARRTP04	187	ARGBU-250MHDG	190	ARBB05	193
ARLTGN45-50MI	184	ARRTP05	187	ARGBU-300MHDG	190	ARBB06	193
ARLTGN45-75MI	184	ARRTP06	187	ARGBU-350MHDG	190	ARBB07	193
ARLTGN45-100MI	184	ARRCT-50MI	188	ARGBU-400MHDG	190	ARBB08	193
ARLTGN45-125MI	184	ARRCT-75MI	188	ARGBU-50I	191	ARBB09	193
ARLTGN45-150MI	184	ARRCT-100MI	188	ARGBU-75I	191	ARBB10	193
ARLTGN45-200MI	184	ARRCT-125MI	188	ARGBU-100I	191	ARBB11	193
ARLTGN45-250MI	184	ARRCT-150MI	188	ARGBU-125I	191	ARBB12	193
ARLTGN45-300MI	184	ARRCT-200MI	188	ARGBU-150I	191	ARMCHN-50HDG	194
ARLTGN45-350MI	184	ARRCT-250MI	188	ARGBU-200I	191	ARMCHN-75HDG	194
ARLTGN45-400MI	184	ARRCT-300MI	188	ARGBU-250I	191	ARMCHN-100HDG	194
ARLTGN90-38MI	184	ARRCT-350MI	188	ARGBU-300I	191	ARMCHN-125HDG	194
ARLTGN90-50MI	184	ARRCT-400MI	188	ARGBU-350I	191	ARMCHN-150HDG	194
ARLTGN90-75MI	184	ARSTRC-50MI	188	ARGBU-400I	191	ARMCHN-200HDG	194
ARLTGN90-100MI	184	ARSTRC-75MI	188	ARGBU-125IA	191	ARMCHN-250HDG	194
ARLTGN90-125MI	184	ARSTRC-100MI	188	ARGBU-150IA	191	ARMCHN-300HDG	194
ARLTGN90-150MI	184	ARSTRC-125MI	188	ARGBU-200IA	191	ARMCHN-350HDG	194
ARLTGN90-200MI	184	ARSTRC-150MI	188	ARGBU-250IA	191	ARMCHN-400HDG	194
ARLTGN90-250MI	184	ARSTRC-200MI	188	ARGBU-300IA	191	ARRACS-50HDG	195
ARLTGN90-300MI	184	ARSTRC-250MI	188	ARGBU-350IA	191	ARRACS-75HDG	195
ARLTGN90-350MI	184	ARSTRC-300MI	188	ARGBU-400IA	191	ARRACS-100HDG	195
ARLTGN90-400MI	184	ARSTRC-400MI	188	ARRB7550	192	ARRACS-125HDG	195
ARSSLT-38I	185	ARTPC-50S	189	ARRB10050	192	ARRACS-150HDG	195
ARSSLT-50I	185	ARTPC-75S	189	ARRB10075	192	ARRACS-200HDG	195
ARSSLT-75I	185	ARTPC-100S	189	ARRB12550	192	ARRACS-250HDG	195
ARSSLT-100I	185	ARTPC-125S	189	ARRB12575	192	ARRACS-300HDG	195
ARSSLT-125I	185	ARTPC-150S	189	ARRB125100	192	ARRACS-350HDG	195
ARSSLT-150I	185	ARTPC-200S	189	ARRB15075	192	ARRACS-400HDG	195
ARSSLT-200I	185	ARTPC-50	189	ARRB150100	192	ARRACS-38MI	195
ARCCPLT-38	185	ARTPC-75	189	ARRB150125	192	ARRACS-50MI	195
ARCCPLT-50	185	ARTPC-100	189	ARRB20075	192	ARRACS-75MI	195
ARCCPLT-75	185	ARTPC-125	189	ARRB200125	192	ARRACS-100MI	195
ARCCPLT-100	185	ARTPC-150	189	ARRB200150	192	ARRACS-125MI	195
ARCCPLT-125	185	ARTPC-200	189	ARRB250150	192	ARRACS-150MI	195
ARCCPLT-150	185	ARTPC-250	189	ARRB300150	192	ARRACS-200MI	195
ARCCPLT-200	185	ARTPC-300	189	ARRB300200	192	ARRACS-250MI	195
ARRC01	186	ARTPC-350	189	ARRB300250	192	ARRACS-300MI	195
ARRC02	186	ARTPC-400	189	ARRB400300	192	ARRACS-350MI	195
ARRC03	186	ARTPC-500	189	ARRB400350	192	ARRACS-400MI	195
ARRC04	186	ARTPC-50HDG	189	ARBU-50MI	192	ARPCS-50MI	196
ARRC05	186	ARTPC-75HDG	189	ARBU-75MI	192	ARPCS-75MI	196
ARRC06	186	ARTPC-100HDG	189	ARBU-100MI	192	ARPCS-100MI	196
ARRC07	186	ARTPC-125HDG	189	ARBU-125MI	192	ARPCS-125MI	196
ARRC08	186	ARTPC-150HDG	189	ARBU-150MI	192	ARPCS-150MI	196
ARRC09	186	ARTPC-200HDG	189	ARBU-200MI	192	ARPCS-200MI	196
ARRC10	186	ARTPC-250HDG	189	ARBU-250MI	192	ARPCS-250MI	196
ARRP01	186	ARTPC-300HDG	189	ARBU-300MI	192	ARPCS-300MI	196
ARRP02	186	ARTPC-350HDG	189	ARBU-350MI	192	ARPCS-350MI	196
ARRP03	186	ARTPC-400HDG	189	ARBU-400MI	192	ARPCS-400MI	196
ARRP04	186	ARGB-50I	190	ARBU-500MI	192	ARPCS-50HDG	196
ARRP05	186	ARGB-75I	190	ARBU-600MI	192	ARPCS-75HDG	196

ARPCS-100HDG	196	ARGL-75	199	AR510BX	202	ARCD2-6	206
ARPCS-125HDG	196	ARGL-100	199	ARTHS-50	202	ARCD2-7	206
ARPCS-150HDG	196	ARGL-125	199	ARTHS-75	202	ARCD2-8	206
ARPCS-200HDG	196	ARGL-150	199	ARTHS-100	202	ARCD2-9	206
ARPCS-250HDG	196	ARGL-200	199	ARTHS-125	202	ARCD2-10	206
ARPCS-300HDG	196	ARGL-250	199	ARTHS-150	202	ARCD2-11	206
ARPCS-350HDG	196	ARGL-300	199	ARTHS-200	202	ARCD2-12	206
ARPCS-400HDG	196	ARGL-350	199	ARTHS-250	202	ARCD1/0-1	207
ARECSM-50HDG	197	ARGL-400	199	ARTHS-300	202	ARCD1/0-2	207
ARECSM-75HDG	197	ARCN-50	200	ARTHS-350	202	ARCD1/0-3	207
ARECSM-100HDG	197	ARCN-75	200	ARTHS-400	202	ARCD1/0-4	207
ARECSM-125HDG	197	ARCN-100	200	ARTHS-500	202	ARCD1/0-5	207
ARECSM-150HDG	197	ARCN-125	200	ARTHS-600	202	ARCD1/0-6	207
ARECSM-200HDG	197	ARCN-150	200	ARROHS-50	203	ARCD1/0-7	207
ARECSM-250HDG	197	ARCN-200	200	ARROHS-75	203	ARCD1/0-8	207
ARECSM-300HDG	197	ARCN-250	200	ARROHS-100	203	ARCD1/0-9	207
ARECSM-50MI	197	ARCN-300	200	ARROHS-125	203	ARCD1/0-10	207
ARECSM-75MI	197	ARCN-350	200	ARROHS-150	203	ARCD1/0-11	207
ARECSM-100MI	197	ARCN-400	200	ARROHS-200	203	ARCD1/0-12	207
ARECSM-125MI	197	ARCNM-50	200	ARROHS-250	203	ARCD3/0-1	207
ARECSM-150MI	197	ARCNM-75	200	ARROHS-300	203	ARCD3/0-2	207
ARECSM-200MI	197	ARCNM-100	200	ARROHS-350	203	ARCD3/0-3	207
ARECSM-250MI	197	ARCNM-125	200	ARROHS-400	203	ARCD3/0-4	207
ARECSM-300MI	197	ARCNM-150	200	ARROHS-500	203	ARCD3/0-5	207
ARWTH-50	198	ARCNM-200	200	ARROHS-600	203	ARCD3/0-6	207
ARWTH-75	198	ARCNM-250	200	ARRTHS-50	203	ARCD3/0-7	207
ARWTH-100	198	ARCNM-300	200	ARRTHS-75	203	ARCD3/0-8	207
ARWTH-125	198	ARCNM-350	200	ARRTHS-100	203	ARCD3/0-9	207
ARWTH-150	198	ARCNM-400	200	ARRTHS-125	203	ARCD3/0-10	207
ARWTH-200	198	ARCNM-500	200	ARRTHS-150	203	ARCD3/0-11	207
ARWTH-250	198	ARCNM-600	200	ARRTHS-200	203	ARCD3/0-12	207
ARWTH-300	198	ARCNM-50I	201	ARRTHS-250	203	ARCD2/0-1	207
ARWTH-350	198	ARCNM-75I	201	ARRTHS-300	203	ARCD2/0-2	207
ARWTH-400	198	ARCNM-100I	201	ARRTHS-350	203	ARCD2/0-3	207
ARGWTH-50	198	ARCNM-125I	201	ARRTHS-400	203	ARCD2/0-4	207
ARGWTH-75	198	ARCNM-150I	201	ARRTHS-500	203	ARCD2/0-5	207
ARGWTH-100	198	ARCNM-200I	201	ARRTHS-600	203	ARCD2/0-6	207
ARGWTH-125	198	ARCNM-250I	201	AROHSM-38	203	ARCD2/0-7	207
ARGWTH-150	198	ARCNM-300I	201	AROHSM-50	203	ARCD2/0-8	207
ARGWTH-200	198	ARCNM-350I	201	AROHSM-75	203	ARCD2/0-9	207
ARGWTH-250	198	ARCNM-400I	201	AROHSM-100	203	ARCD2/0-10	207
ARGWTH-300	198	ARCNM-500I	201	AROHSM-125	203	ARCD2/0-11	207
ARGWTH-350	198	ARCNM-600I	201	AROHSM-150	203	ARCD2/0-12	207
ARGWTH-400	198	AROCNZ-50	201	AROHSM-200	203	ARCD250-1	208
ARLNS-50	199	AROCNZ-75	201	AROHSM-250	203	ARCD250-2	208
ARLNS-75	199	AROCNZ-100	201	AROHSM-300	203	ARCD250-3	208
ARLNS-100	199	AROCNZ-125	201	AROHSM-350	203	ARCD250-4	208
ARLNS-125	199	AROCNZ-150	201	AROHSM-400	203	ARCD250-5	208
ARLNS-150	199	AROCNZ-200	201	ARCBM-50	204	ARCD250-6	208
ARLNS-200	199	AROCNZ-250	201	ARCBM-75	204	ARCD250-7	208
ARLNS-250	199	AROCNZ-300	201	ARCBM-100	204	ARCD250-8	208
ARLNS-300	199	AROCNZ-350	201	ARCBM-125	204	ARCD250-9	208
ARLNS-350	199	AROCNZ-400	201	ARCBM-150	204	ARCD250-10	208
ARLNS-400	199	AROS-50	202	ARCBM-200	204	ARCD250-11	208
ARSL-50	199	AROS-75	202	ARCBM-250	204	ARCD250-12	208
ARSL-75	199	AROS-100	202	ARCBM-300	204	ARCD350-1	208
ARSL-100	199	AROS-125	202	ARCBM-350	204	ARCD350-2	208
ARSL-125	199	AROS-150	202	ARCBM-400	204	ARCD350-3	208
ARSL-150	199	AROS-200	202	ARSTPE	205	ARCD350-4	208
ARSL-200	199	AROS-250	202	ARSTPI	205	ARCD350-5	208
ARSL-250	199	AROS-300	202	ARCD2-1	206	ARCD350-6	208
ARSL-300	199	AROS-350	202	ARCD2-2	206	ARCD350-7	208
ARSL-350	199	AROS-400	202	ARCD2-3	206	ARCD350-8	208
ARSL-400	199	AROS-500	202	ARCD2-4	206	ARCD350-9	208
ARGL-50	199	AROS-600	202	ARCD2-5	206	ARCD350-10	208

ARCD350-11	208	AWCT-100	211	A8P58SM	220	A812M4I	224
ARCD350-12	208	AWCT-500	211	A8P912SM	220	A16M4I	224
ARCD750-1	209	AWCY-100	211	A12P24SM	220	A20M4I	224
ARCD750-2	209	AWCY-500	211	A12P58SM	220	A24M4I	224
ARCD750-3	209	ARBT04-100	212	A12P912SM	220	A32M4I	224
ARCD750-4	209	ARBT04-1000	212	A16P24SM	220	AKX	224
ARCD750-5	209	ARBT05-100	212	A16P58SM	220	AK8	224
ARCD750-6	209	ARBT05-1000	212	A16P912SM	220	AK12	224
ARCD750-7	209	ARBT07-100	212	A8P24	220	AK16	224
ARCD750-8	209	ARBT07-1000	212	A8P58	220	AK20	224
ARCD750-9	209	ARBT08-100	212	A8P912	220	A4Z34	225
ARCD750-10	209	ARBT08-1000	212	A12P24	220	A4Z4S	225
ARCD750-11	209	ARBT11-100	212	A12P58	220	A4Z348P	225
ARCD750-12	209	ARBT11-1000	212	A12P912	220	A4Z3412P	225
ARCD500-1	209	ARBT14-100	212	A16P24	220	A4Z3416P	225
ARCD500-2	209	ARBT14-1000	212	A16P58	220	A6Z348P	225
ARCD500-3	209	ARBT18-100	212	A16P912	220	A6Z3412P	225
ARCD500-4	209	ARBT18-1000	212	A6A24	221	A6Z3416P	225
ARCD500-5	209	ARWT04-100	213	A6A912	221	A4Z34812M	225
ARCD500-6	209	ARWT04-1000	213	A4TI24	221	A4Z3416M	225
ARCD500-7	209	ARWT05-100	213	A4TI58	221	A4Z346M	225
ARCD500-8	209	ARWT05-1000	213	A4TI912	221	A6Z34812M	225
ARCD500-9	209	ARWT07-100	213	A6M24SM	222	A6Z3416M	225
ARCD500-10	209	ARWT07-1000	213	A6M58SM	222	A8P	226
ARCD500-11	209	ARWT08-100	213	A6M912SM	222	A12P	226
ARCD500-12	209	ARWT08-1000	213	A812M24SM	222	A16P	226
ARCD600-1	209	ARWT11-100	213	A812M58SM	222	ARCH-50	226
ARCD600-2	209	ARWT11-1000	213	A812M912SM	222	ARCH-75	226
ARCD600-3	209	ARWT14-100	213	A16M24SM	222	ARCH-100	226
ARCD600-4	209	ARWT14-1000	213	A16M58SM	222	ARCH-125	226
ARCD600-5	209	ARWT18-100	213	A16M912SM	222	ARCH-150	226
ARCD600-6	209	ARWT18-1000	213	A20M24SM	222	ARCH-200	226
ARCD600-7	209	ARHBT04-100	214	A20M58SM	222	ARCH-250	226
ARCD600-8	209	ARHBT04-1000	214	A20M912SM	222	ARCH-300	226
ARCD600-9	209	ARHBT06-100	214	A24M24SM	222	ARCH-350	226
ARCD600-10	209	ARHBT06-1000	214	A24M58SM	222	ARCH-400	226
ARCD600-11	209	ARHBT07-100	214	A24M912SM	222	A449	227
ARCD600-12	209	ARHBT07-1000	214	A32M24SM	222	AMAC2	227
ET-001	210	ARHBT08-100	214	A32M58SM	222	ARMX58	227
ET-002	210	ARHBT08-1000	214	A32M912SM	222	ASC2A	228
ET-003	210	ARHBT11-100	214	A6M24	223	ASC2B	228
ET-004	210	ARHBT11-1000	214	A6M58	223	ASC2C	228
ET-005	210	ARHBT14-100	214	A6M912	223	ASC2D	228
ET-006	210	ARHBT14-1000	214	A812M24	223	ASC2E	228
ET-007	210	ARHBT18-100	214	A812M58	223	ASC2F	228
ET-008	210	ARHBT18-1000	214	A812M912	223	ASC2G	228
ET-009	210	ARHWT04-100	215	A16M24	223	ASC4A	228
ET-010	210	ARHWT04-1000	215	A16M58	223	ASC4B	228
ET-011	210	ARHWT05-100	215	A16M912	223	ASC4C	228
AWCBF-100	211	ARHWT05-1000	215	A20M24	223	ASC4D	228
AWCBF-500	211	ARHWT07-100	215	A20M58	223	ASC4E	228
AWCGF-100	211	ARHWT07-1000	215	A20M912	223	ASC4F	228
AWCGF-500	211	ARHWT08-100	215	A24M24	223	ASC4G	228
AWCOF-100	211	ARHWT08-1000	215	A24M58	223	APCS1	228
AWCOF-500	211	ARHWT11-100	215	A24M912	223	A6MB18A	229
AWCRF-100	211	ARHWT11-1000	215	A32M24	223	A812MB18S	229
AWCRF-500	211	ARHWT14-100	215	A32M58	223	A812MB18A	229
AWCYF-100	211	ARHWT14-1000	215	A32M912	223	A16MB18A	229
AWCYF-500	211	ARHWT18-100	215	A6M	224	AMX3	229
AWCB-100	211	ARHWT18-1000	215	A812M	224	AMX6	229
AWCB-500	211	ARMP4A	216	A16M	224	A740	229
AWCG-100	211	ARMP4AB	216	A20M	224	ARMBC-1024	230
AWCG-500	211	ARMP4S	217	A24M	224	ARMBC-1420	230
AWCR-100	211	ARMP4SB	217	A32M	224	ARMBC-3816	230
AWCR-500	211	A8P24SM	220	A6M4I	224	ARMBC-1213	230

ARBC002	230	A16MF	239	ARLSH-1	247	ARBOLT1-138L	250
ARBC001	230	A20MF	239	ARLSH-2	247	ARBOLT1-1038L	250
AVF14	230	A812MF	239	ARLSH-3	247	ARBOLT1-2038L	250
A2H4	231	A350812M	239	ARLSH-4	247	ARBOLT1-3038L	250
A4H24	231	AMCJ6	239	ARLSH-5	247	ARBOLT1-3050L	250
A4H58	231	GR58X8-N/UL	242	ARLSH-6	247	ARBOLT1-4050L	250
A4H912	231	58-8CCSGR	242	ARLSH-7	247	ARBOLT1-25050L	250
AM24	231	34-8CCSGR	242	ARLSH-8	247	ARBOLT1-30050L	250
AM58	231	58-10CCSGR	242	ARLSH-9	247	ARBOLT1-35050L	250
AM912	231	34-10CCSGR	242	ARLSH-10	247	ARBOLT1-40050L	250
AM24S	231	58-8GGR	242	ARBARREL-8S	248	ARBOLT1-50050L	250
AM58S	231	ARBGRC-34	243	ARBARREL-6S	248	ARBOLT1-60058L	250
AM912S	231	ARBGRC-58	243	ARBARREL-4S	248	ARBOLT1-75058L	250
A123812M	232	ARSB10	243	ARBARREL-2S	248	ARBOLT2-810S	251
A122	232	ARSB8	243	ARBARREL-1S	248	ARBOLT2-625S	251
A1224TI	232	ARSB6	243	ARBARREL-10S	248	ARBOLT2-425S	251
A1226TI	232	ARSB4	243	ARBARREL-20S	248	ARBOLT2-2516S	251
AAF14	232	ARSB2	243	ARBARREL-30S	248	ARBOLT2-2050S	251
AAF146TI	232	ARSB1/0	243	ARBARREL-40S	248	ARBOLT2-3050S	251
AAF144TI	232	ARSB2/0	243	ARBARREL-250S	248	ARBOLT2-4050S	251
A512HDEEP	233	ARSB3/0	243	ARBARREL-350S	248	ARBOLT2-25050S	251
A4G16H	233	ARSB4/0-250	243	ARBARREL-400S	248	ARBOLT2-30050S	251
A4G16	233	ARSB350	243	ARBARREL-500S	248	ARBOLT2-35050S	251
A812MATA	234	ARSB500	243	ARBARREL-600S	248	ARBOLT2-40050S	251
A6MATA	234	ARGCDB-630DB	244	ARBARREL-750S	248	ARBOLT2-50050S	251
A8PATS	234	ARGCBW-626A	244	ARBARREL-8L	249	ARBOLT2-60038S	251
AATS4I	234	ARGCBW-626BS	244	ARBARREL-6L	249	ARBOLT2-75050S	251
AIDS	235	ARGCBW-626B	244	ARBARREL-4L	249	ARBOLT2-825L	251
A6TIB	235	ARGCBW-626C	244	ARBARREL-2L	249	ARBOLT2-625L	251
A4TIB	235	ARGCBW-626D	244	ARBARREL-10L	249	ARBOLT2-425L	251
A4TI	235	ARGCAW-630B	244	ARBARREL-20L	249	ARBOLT2-250L	251
A6TI	235	ARGCAW-630	244	ARBARREL-30L	249	ARBOLT2-1050L	251
A6T	235	ARGCBW-01Z	244	ARBARREL-40L	249	ARBOLT2-2050L	251
AMSS24	236	AR-HB50	244	ARBARREL-250L	249	ARBOLT2-3050L	251
AMSS58	236	AR-HB75	244	ARBARREL-300L	249	ARBOLT2-4050L	251
AMSS912	236	AR-HB100	244	ARBARREL-350L	249	ARBOLT2-25050L	251
AMSS122	236	ARGCH-50A	245	ARBARREL-400L	249	ARBOLT2-30050L	251
AMSR122	236	ARGCH-75A	245	ARBARREL-500L	249	ARBOLT2-35050L	251
AMSR24	236	ARGCH-100A	245	ARBARREL-600L	249	ARBOLT2-40050L	251
AMSR58	236	ARGCH-50B	245	ARBARREL-750L	249	ARBOLT2-50050L	251
AAB375	236	ARGCH-75B	245	ARBOLT1-810S	250	ARBOLT2-60012L	251
ARJH001	237	ARGCH-100B	245	ARBOLT1-825S	250	ARBOLT2-75012L	251
ARJH002	237	ARGCBW-625	245	ARBOLT1-625S	250	GB2-6	252
ARJH003	237	ARGCBW-626	245	ARBOLT1-6516S	250	GB2-12	252
ARJH004	237	ARGCBW-627	245	ARBOLT1-425S	250	GB4-12	252
ACAT124Z34	237	ARGCBW-628	245	ARBOLT1-4516S	250	GB4-24	252
ACAT126Z34	237	ARLS-14-1/0	246	ARBOLT1-438S	250	AR973	253
ARBR125	237	ARLS-14-2/0	246	ARBOLT1-238S	250	AR996	253
ARBR150	237	ARLS-14-2	246	ARBOLT1-138S	250	AR996	253
ARBR200	237	ARLS-14-6	246	ARBOLT1-1038S	250	ARTR146	256
ARBR400	237	ARLS-4-500	246	ARBOLT1-2038S	250	ARTR148	256
ARWBR75	237	ARLS-6-4/0	246	ARBOLT1-2050S	250	ARTR1410	256
ARWBR125	237	ARLS-6-300	246	ARBOLT1-3038S	250	ARTR386	256
ARWBR150	237	ARLS-6-350	246	ARBOLT1-4050S	250	ARTR388	256
ARWBR200	237	ARLS-9-600	246	ARBOLT1-25050S	250	ARTR3810	256
ARWBR400	237	ARLS-350-800	246	ARBOLT1-30050S	250	ARTR126	256
ARCBS	238	ARLD-14-1/0	246	ARBOLT1-35050S	250	ARTR128	256
A2FMP28	238	ARLD-14-2/0	246	ARBOLT1-40050S	250	ARTR1210	256
AKBT	238	ARLD-2-600	246	ARBOLT1-50050S	250	ARTR586	256
AFXC20	239	ARLD-6-250	246	ARBOLT1-60050S	250	ARTR588	256
ACS812D	239	ARLD-6-350	246	ARBOLT1-75058S	250	ARTR5810	256
ACS812	239	ARLD-300-800	246	ARBOLT1-825L	250	ARTR346	256
ACS16	239	ARLSA-1	247	ARBOLT1-625L	250	ARTR348	256
A304B2	239	ARLSA-2	247	ARBOLT1-425L	250	ARTR3410	256
A6MF	239	ARLSA-3	247	ARBOLT1-238L	250	ARSTSL-1-5/8-12-20FT-HDG	257

ARSTSL-1-5/8-14-20FT-HDG	257	ARSNCN1213	261	THHN14-RD-STR-500	269	THHN8-GRY-STR-1000	271
ARSTSL-13/16-12-20FT-HDG	257	ARSTC-10FT	261	THHN14-RD-STR-1000	269	THHN8-GRY-STR-2500	271
ARSTSL-13/16-14-20FT-HDG	257	ARSTC-20FT	261	THHN14-RD-STR-2500	269	THHN8-GRY-STR-5000	271
ARSTSL-1-5/8-12-10FT-HDG	257	ARFW38	262	THHN14-RD-STR-5000	269	THHN8-OR-STR-500	271
ARSTSL-1-5/8-14-10FT-HDG	257	ARFW12	262	THHN14-WH-STR-500	269	THHN8-OR-STR-1000	271
ARSTSL-13/16-12-10FT-HDG	257	ARFW58	262	THHN14-WH-STR-1000	269	THHN8-OR-STR-2500	271
ARSTSL-13/16-14-10FT-HDG	257	ARFW34	262	THHN14-WH-STR-2500	269	THHN8-OR-STR-5000	271
ARSTSL-1-5/8-12-10FT-PG	257	ARUHN14	263	THHN14-WH-STR-5000	269	THHN8-RD-STR-500	271
ARSTSL-1-5/8-14-10FT-PG	257	ARUHN38	263	THHN14-YW-STR-500	269	THHN8-RD-STR-1000	271
ARSTSL-13/16-12-10FT-PG	257	ARUHN12	263	THHN14-YW-STR-1000	269	THHN8-RD-STR-2500	271
ARSTSL-13/16-14-10FT-PG	257	ARUHN58	263	THHN14-YW-STR-2500	269	THHN8-RD-STR-5000	271
ARSTSL-1-5/8-12-20FT-PG	257	ARUHN34	263	THHN14-YW-STR-5000	269	THHN8-WH-STR-500	271
ARSTSL-1-5/8-14-20FT-PG	257	CAT6-CCA-B	266	THHN12-BE-STR-500	270	THHN8-WH-STR-1000	271
ARSTSL-13/16-12-20FT-PG	257	CAT6-CCA-W	266	THHN12-BE-STR-1000	270	THHN8-WH-STR-2500	271
ARSTSL-13/16-14-20FT-PG	257	CAT6-CCA-GN	266	THHN12-BE-STR-2500	270	THHN8-WH-STR-5000	271
ARSTSO-1-5/8-12-20FT-HDG-BTB	258	CAT6-CCA-GY	266	THHN12-BE-STR-5000	270	THHN8-YW-STR-500	271
ARSTSO-13/16-12-20FT-HDG-BTB	258	CAT6-CCA-R	266	THHN12-BK-STR-500	270	THHN8-YW-STR-1000	271
ARSTSO-1-5/8-12-10FT-HDG-BTB	258	CAT6-CCA-Y	266	THHN12-BK-STR-1000	270	THHN8-YW-STR-2500	271
ARSTSO-13/16-12-10FT-HDG-BTB	258	CAT5E-CCA-B	266	THHN12-BK-STR-2500	270	THHN8-YW-STR-5000	271
ARSTSO-1-5/8-12-10FT-HDG	258	CAT5E-CCA-W	266	THHN12-BK-STR-5000	270	THHN10-BE-STR-500	272
ARSTSO-13/16-12-10FT-HDG	258	CAT5E-CCA-GN	266	THHN12-BR-STR-500	270	THHN10-BE-STR-1000	272
ARSTSL-1-5/8-12-10FT-HDG-BTB	258	CAT5E-CCA-GY	266	THHN12-BR-STR-1000	270	THHN10-BE-STR-2500	272
ARSTSL-13/16-12-10FT-HDG-BTB	258	CAT5E-CCA-R	266	THHN12-BR-STR-2500	270	THHN10-BE-STR-5000	272
ARSTSO-1-5/8-12-20FT-HDG	258	CAT5E-CCA-Y	266	THHN12-BR-STR-5000	270	THHN10-BK-STR-500	272
ARSTSO-13/16-12-20FT-HDG	258	CAT6E-FLUKE-B	267	THHN12-BR-STR-1000	270	THHN10-BK-STR-1000	272
ARSTSL-1-5/8-12-20FT-HDG-BTB	258	CAT6E-FLUKE-W	267	THHN12-BR-STR-2500	270	THHN10-BK-STR-2500	272
ARSTSL-13/16-12-20FT-HDG-BTB	258	CAT6E-FLUKE-GN	267	THHN12-BR-STR-5000	270	THHN10-BK-STR-5000	272
ARSFP01	259	CAT6E-FLUKE-GY	267	THHN12-GN-STR-500	270	THHN10-BR-STR-500	272
ARSFP02	259	CAT6E-FLUKE-R	267	THHN12-GN-STR-1000	270	THHN10-BR-STR-1000	272
ARSFP03	259	CAT6E-FLUKE-Y	267	THHN12-GN-STR-2500	270	THHN10-BR-STR-2500	272
ARSFP04	259	CAT6P	267	THHN12-GN-STR-5000	270	THHN10-BR-STR-5000	272
ARSFP05	259	CAT6-CMP-B	267	THHN12-OR-STR-500	270	THHN10-GN-STR-500	272
ARSFP06	259	CAT6-CMP-W	267	THHN12-OR-STR-1000	270	THHN10-GN-STR-1000	272
ARSFP07	259	CAT6-CMP-GN	267	THHN12-OR-STR-2500	270	THHN10-GN-STR-2500	272
ARSFP08	259	CAT6-CMP-GY	267	THHN12-OR-STR-5000	270	THHN10-GN-STR-5000	272
ARSFP09	259	CAT6-CMP-R	267	THHN12-RD-STR-500	270	THHN10-OR-STR-500	272
ARSTCP-50	260	CAT6-CMP-Y	267	THHN12-RD-STR-1000	270	THHN10-OR-STR-1000	272
ARSTCP-75	260	RG6 DUAL B	268	THHN12-RD-STR-2500	270	THHN10-OR-STR-2500	272
ARSTCP-100	260	RG6 DUAL WH	268	THHN12-RD-STR-5000	270	THHN10-OR-STR-5000	272
ARSTCP-125	260	RG6 QUAL B	268	THHN12-WH-STR-500	270	THHN10-RD-STR-500	272
ARSTCP-150	260	RG6 QUAL WH	268	THHN12-WH-STR-1000	270	THHN10-RD-STR-1000	272
ARSTCP-200	260	THHN14-BE-STR-500	269	THHN12-WH-STR-2500	270	THHN10-RD-STR-2500	272
ARSTCP-250	260	THHN14-BE-STR-1000	269	THHN12-WH-STR-5000	270	THHN10-RD-STR-5000	272
ARSTCP-300	260	THHN14-BE-STR-2500	269	THHN12-YW-STR-500	270	THHN10-WH-STR-500	272
ARSTCP-350	260	THHN14-BE-STR-5000	269	THHN12-YW-STR-1000	270	THHN10-WH-STR-1000	272
ARSTCP-400	260	THHN14-BK-STR-500	269	THHN12-YW-STR-2500	270	THHN10-WH-STR-2500	272
ARSTC0038	260	THHN14-BK-STR-1000	269	THHN12-YW-STR-5000	270	THHN10-WH-STR-5000	272
ARSTC001	260	THHN14-BK-STR-2500	269	THHN12-GRY-STR-500	270	THHN10-YW-STR-500	272
ARSTC002	260	THHN14-BK-STR-5000	269	THHN12-GRY-STR-1000	270	THHN10-YW-STR-1000	272
ARSTC003	260	THHN14-BR-STR-500	269	THHN12-GRY-STR-2500	270	THHN10-YW-STR-2500	272
ARSTC004	260	THHN14-BR-STR-1000	269	THHN12-GRY-STR-5000	270	THHN10-YW-STR-5000	272
ARSTC005	260	THHN14-BR-STR-2500	269	THHN8-BE-STR-500	271	THHN10-GRY-STR-500	272
ARSTC006	260	THHN14-BR-STR-5000	269	THHN8-BE-STR-1000	271	THHN10-GRY-STR-1000	272
ARSTC007	260	THHN14-GN-STR-500	269	THHN8-BE-STR-2500	271	THHN10-GRY-STR-2500	272
ARSTC008	260	THHN14-GN-STR-1000	269	THHN8-BE-STR-5000	271	THHN10-GRY-STR-5000	272
ARSTC009	260	THHN14-GN-STR-2500	269	THHN8-BK-STR-500	271	THHN6-BE-STR-500	273
ARSTC010	260	THHN14-GN-STR-5000	269	THHN8-BK-STR-1000	271	THHN6-BE-STR-1000	273
ARSN1420-R	261	THHN14-GN-STR-500	269	THHN8-BK-STR-2500	271	THHN6-BE-STR-2500	273
ARSN1420-S	261	THHN14-GN-STR-1000	269	THHN8-BK-STR-5000	271	THHN6-BE-STR-5000	273
ARSN3816-R	261	THHN14-GN-STR-2500	269	THHN8-BR-STR-500	271	THHN6-BK-STR-500	273
ARSN3816-S	261	THHN14-GN-STR-5000	269	THHN8-BR-STR-1000	271	THHN6-BK-STR-1000	273
ARSN1213-R	261	THHN14-OR-STR-500	269	THHN8-BR-STR-2500	271	THHN6-BK-STR-2500	273
ARSN1213-S	261	THHN14-OR-STR-1000	269	THHN8-BR-STR-5000	271	THHN6-BK-STR-5000	273
ARSNCN1420	261	THHN14-OR-STR-2500	269	THHN8-GN-STR-500	271	THHN6-BR-STR-500	273
ARSNCN3816	261	THHN14-OR-STR-5000	269	THHN8-GN-STR-1000	271	THHN6-BR-STR-1000	273
				THHN8-GN-STR-2500	271		
				THHN8-GN-STR-5000	271		
				THHN8-GRY-STR-500	271		

THHN6-BR-STR-2500	273	THHN3-RD-STR-2500	275	THHN2/0-WH-STR-1000	277	THHN300-YW-STR-1000	279
THHN6-BR-STR-5000	273	THHN3-WH-STR-1000	275	THHN2/0-WH-STR-2500	277	THHN300-YW-STR-2500	279
THHN6-GN-STR-500	273	THHN3-WH-STR-2500	275	THHN2/0-YW-STR-1000	277	THHN350-BE-STR-1000	279
THHN6-GN-STR-1000	273	THHN3-YW-STR-1000	275	THHN2/0-YW-STR-2500	277	THHN350-BE-STR-2500	279
THHN6-GN-STR-2500	273	THHN3-YW-STR-2500	275	THHN3/0-BE-STR-1000	277	THHN350-BK-STR-1000	279
THHN6-GN-STR-5000	273	THHN2-BE-STR-1000	275	THHN3/0-BE-STR-2500	277	THHN350-BK-STR-2500	279
THHN6-OR-STR-500	273	THHN2-BE-STR-2500	275	THHN3/0-BK-STR-1000	277	THHN350-BR-STR-1000	279
THHN6-OR-STR-1000	273	THHN2-BK-STR-1000	275	THHN3/0-BK-STR-2500	277	THHN350-BR-STR-2500	279
THHN6-OR-STR-2500	273	THHN2-BK-STR-2500	275	THHN3/0-BR-STR-1000	277	THHN350-GN-STR-1000	279
THHN6-OR-STR-5000	273	THHN2-BR-STR-1000	275	THHN3/0-BR-STR-2500	277	THHN350-GN-STR-2500	279
THHN6-RD-STR-500	273	THHN2-BR-STR-2500	275	THHN3/0-GN-STR-1000	277	THHN350-OR-STR-1000	279
THHN6-RD-STR-1000	273	THHN2-GN-STR-1000	275	THHN3/0-GN-STR-2500	277	THHN350-OR-STR-2500	279
THHN6-RD-STR-2500	273	THHN2-GN-STR-2500	275	THHN3/0-OR-STR-1000	277	THHN350-RD-STR-1000	279
THHN6-RD-STR-5000	273	THHN2-OR-STR-1000	275	THHN3/0-OR-STR-2500	277	THHN350-RD-STR-2500	279
THHN6-WH-STR-500	273	THHN2-OR-STR-2500	275	THHN3/0-RD-STR-1000	277	THHN350-WH-STR-1000	279
THHN6-WH-STR-1000	273	THHN2-RD-STR-1000	275	THHN3/0-RD-STR-2500	277	THHN350-WH-STR-2500	279
THHN6-WH-STR-2500	273	THHN2-RD-STR-2500	275	THHN3/0-WH-STR-1000	277	THHN350-YW-STR-1000	279
THHN6-WH-STR-5000	273	THHN2-WH-STR-1000	275	THHN3/0-WH-STR-2500	277	THHN350-YW-STR-2500	279
THHN6-YW-STR-500	273	THHN2-WH-STR-2500	275	THHN3/0-YW-STR-1000	277	THHN400-BE-STR-1000	280
THHN6-YW-STR-1000	273	THHN2-YW-STR-1000	275	THHN3/0-YW-STR-2500	277	THHN400-BE-STR-2500	280
THHN6-YW-STR-2500	273	THHN2-YW-STR-2500	275	THHN4/0-BE-STR-1000	278	THHN400-BK-STR-1000	280
THHN6-YW-STR-5000	273	THHN1-BE-STR-1000	276	THHN4/0-BE-STR-2500	278	THHN400-BK-STR-2500	280
THHN4-BE-STR-500	274	THHN1-BE-STR-2500	276	THHN4/0-BK-STR-1000	278	THHN400-BR-STR-1000	280
THHN4-BE-STR-1000	274	THHN1-BK-STR-1000	276	THHN4/0-BK-STR-2500	278	THHN400-BR-STR-2500	280
THHN4-BE-STR-2500	274	THHN1-BK-STR-2500	276	THHN4/0-BR-STR-1000	278	THHN400-GN-STR-1000	280
THHN4-BE-STR-5000	274	THHN1-BR-STR-1000	276	THHN4/0-BR-STR-2500	278	THHN400-GN-STR-2500	280
THHN4-BK-STR-500	274	THHN1-BR-STR-2500	276	THHN4/0-GN-STR-1000	278	THHN400-OR-STR-1000	280
THHN4-BK-STR-1000	274	THHN1-GN-STR-1000	276	THHN4/0-GN-STR-2500	278	THHN400-OR-STR-2500	280
THHN4-BK-STR-2500	274	THHN1-GN-STR-2500	276	THHN4/0-OR-STR-1000	278	THHN400-OR-STR-1000	280
THHN4-BK-STR-5000	274	THHN1-OR-STR-1000	276	THHN4/0-OR-STR-2500	278	THHN400-RD-STR-2500	280
THHN4-BR-STR-500	274	THHN1-OR-STR-2500	276	THHN4/0-RD-STR-1000	278	THHN400-WH-STR-1000	280
THHN4-BR-STR-1000	274	THHN1-RD-STR-1000	276	THHN4/0-RD-STR-2500	278	THHN400-WH-STR-2500	280
THHN4-BR-STR-2500	274	THHN1-RD-STR-2500	276	THHN4/0-WH-STR-1000	278	THHN400-YW-STR-1000	280
THHN4-BR-STR-5000	274	THHN1-WH-STR-1000	276	THHN4/0-WH-STR-2500	278	THHN400-YW-STR-2500	280
THHN4-GN-STR-500	274	THHN1-WH-STR-2500	276	THHN4/0-YW-STR-1000	278	THHN500-BE-STR-1000	280
THHN4-GN-STR-1000	274	THHN1-YW-STR-1000	276	THHN4/0-YW-STR-2500	278	THHN500-BE-STR-2500	280
THHN4-GN-STR-2500	274	THHN1-YW-STR-2500	276	THHN250-BE-STR-1000	278	THHN500-BK-STR-1000	280
THHN4-GN-STR-5000	274	THHN1/0-BE-STR-1000	276	THHN250-BE-STR-2500	278	THHN500-BK-STR-2500	280
THHN4-OR-STR-500	274	THHN1/0-BE-STR-2500	276	THHN250-BK-STR-1000	278	THHN500-BR-STR-1000	280
THHN4-OR-STR-1000	274	THHN1/0-BK-STR-1000	276	THHN250-BK-STR-2500	278	THHN500-BR-STR-2500	280
THHN4-OR-STR-2500	274	THHN1/0-BK-STR-2500	276	THHN250-BR-STR-1000	278	THHN500-GN-STR-1000	280
THHN4-OR-STR-5000	274	THHN1/0-BR-STR-1000	276	THHN250-BR-STR-2500	278	THHN500-GN-STR-2500	280
THHN4-RD-STR-500	274	THHN1/0-BR-STR-2500	276	THHN250-GN-STR-1000	278	THHN500-OR-STR-1000	280
THHN4-RD-STR-1000	274	THHN1/0-GN-STR-1000	276	THHN250-GN-STR-2500	278	THHN500-OR-STR-2500	280
THHN4-RD-STR-2500	274	THHN1/0-GN-STR-2500	276	THHN250-OR-STR-1000	278	THHN500-RD-STR-1000	280
THHN4-RD-STR-5000	274	THHN1/0-OR-STR-1000	276	THHN250-OR-STR-2500	278	THHN500-RD-STR-2500	280
THHN4-WH-STR-500	274	THHN1/0-OR-STR-2500	276	THHN250-RD-STR-1000	278	THHN500-WH-STR-1000	280
THHN4-WH-STR-1000	274	THHN1/0-RD-STR-1000	276	THHN250-RD-STR-2500	278	THHN500-WH-STR-2500	280
THHN4-WH-STR-2500	274	THHN1/0-RD-STR-2500	276	THHN250-WH-STR-1000	278	THHN500-YW-STR-1000	280
THHN4-WH-STR-5000	274	THHN1/0-WH-STR-1000	276	THHN250-WH-STR-2500	278	THHN500-YW-STR-2500	280
THHN4-YW-STR-500	274	THHN1/0-WH-STR-2500	276	THHN250-YW-STR-2500	278	THHN14-BE-SOL-1000	281
THHN4-YW-STR-1000	274	THHN1/0-YW-STR-1000	276	THHN300-BE-STR-1000	279	THHN14-BE-SOL-500	281
THHN4-YW-STR-2500	274	THHN1/0-YW-STR-2500	276	THHN300-BE-STR-2500	279	THHN14-BK-SOL-1000	281
THHN4-YW-STR-5000	274	THHN2/0-BE-STR-1000	277	THHN300-BK-STR-1000	279	THHN14-BK-SOL-500	281
THHN3-BE-STR-1000	275	THHN2/0-BE-STR-2500	277	THHN300-BK-STR-2500	279	THHN14-BR-SOL-1000	281
THHN3-BE-STR-2500	275	THHN2/0-BK-STR-1000	277	THHN300-BR-STR-1000	279	THHN14-BR-SOL-500	281
THHN3-BK-STR-1000	275	THHN2/0-BK-STR-2500	277	THHN300-BR-STR-2500	279	THHN14-GN-SOL-1000	281
THHN3-BK-STR-2500	275	THHN2/0-BR-STR-1000	277	THHN300-GN-STR-1000	279	THHN14-GN-SOL-500	281
THHN3-BR-STR-1000	275	THHN2/0-BR-STR-2500	277	THHN300-GN-STR-2500	279	THHN14-OR-SOL-1000	281
THHN3-BR-STR-2500	275	THHN2/0-GN-STR-1000	277	THHN300-OR-STR-1000	279	THHN14-OR-SOL-500	281
THHN3-GN-STR-1000	275	THHN2/0-GN-STR-2500	277	THHN300-OR-STR-2500	279	THHN14-RD-SOL-1000	281
THHN3-GN-STR-2500	275	THHN2/0-OR-STR-1000	277	THHN300-RD-STR-1000	279	THHN14-RD-SOL-500	281
THHN3-OR-STR-1000	275	THHN2/0-OR-STR-2500	277	THHN300-RD-STR-2500	279	THHN14-WH-SOL-1000	281
THHN3-OR-STR-2500	275	THHN2/0-RD-STR-1000	277	THHN300-WH-STR-1000	279	THHN14-WH-SOL-500	281
THHN3-RD-STR-1000	275	THHN2/0-RD-STR-2500	277	THHN300-WH-STR-2500	279	THHN14-YW-SOL-1000	281

THHN14-YW-SOL-500	281	THHN4-BE-SOL-1000	285	DR15-BK	297	AR86222	305
THHN12-BE-SOL-1000	282	THHN4-BK-SOL-1000	285	DRSG15-IV	297	AR86442	305
THHN12-BE-SOL-500	282	THHN4-BR-SOL-1000	285	DRSG15-WH	297	AR-WSST	305
THHN12-BK-SOL-1000	282	THHN4-GN-SOL-1000	285	DRSG20-IV	297	AR-WSSD	305
THHN12-BK-SOL-500	282	THHN4-OR-SOL-1000	285	DRSG20-WH	297	AR-WSSB	305
THHN12-BR-SOL-1000	282	THHN4-RD-SOL-1000	285	DRSG15-2-IV	297	AR86522	306
THHN12-BR-SOL-500	282	THHN4-YW-SOL-1000	285	DRSG15-2-WH	297	AR86542	306
THHN12-GN-SOL-1000	282	15IV-ST	289	DRSG20-2-IV	297	AR86552	306
THHN12-GN-SOL-500	282	15WH-ST	289	DRSG20-2-WH	297	AR86572	306
THHN12-OR-SOL-1000	282	20IV-ST	289	DRSGTR20-IV	297	AR86835	306
THHN12-OR-SOL-500	282	20WH-ST	289	DRSGTR20-WH	297	AR86842	306
THHN12-RD-SOL-1000	282	TR-15IV-ST	289	TR15-DHG-WH	298	AR86852	306
THHN12-RD-SOL-500	282	TR-15WH-ST	289	TR20-DHG-WH	298	ARWW-DD	306
THHN12-WH-SOL-1000	282	TR-15WH-ST-RB	289	TR15-DHG-RD	299	AR86533	307
THHN12-WH-SOL-500	282	TRWR-1-IV-ST	289	TR20-DHG-RD	299	ARWW-BBB	307
THHN12-YW-SOL-1000	282	TRWR-1-W-ST	289	RSS50-BK	301	ARWW-DDD	307
THHN12-YW-SOL-500	282	TR-20IV-ST	289	303P3W	301	ARWW-BBBB	307
THHN10-BE-SOL-1000	282	TR-20WH-ST	289	503P4W	301	ARWW-DDDD	307
THHN10-BE-SOL-500	282	TRWR-2-IV-ST	289	302P3W	301	ARWW-RRRR	307
THHN10-BK-SOL-1000	282	TR-USB15-WH	289	502P3W	301	ARWW-TTTT	307
THHN10-BK-SOL-500	282	TR-USB20-WH	289	303P3WSF	301	BWP-WH	308
THHN10-BR-SOL-1000	282	TRWR-2-W-ST	289	502P3WF	301	WPFTS-WH	308
THHN10-BR-SOL-500	282	AR15AADJR	289	503P4WSF	301	DWP1-WH	308
THHN10-GN-SOL-1000	282	DSPS15-IV	290	302P3WSF	301	WP2R-WH	308
THHN10-GN-SOL-500	282	DSPS15-WH	290	503P3WSFM	301	WPSR-WH	308
THHN10-OR-SOL-1000	282	D3WS15-IV	290	503P3WSF	301	M1PF-WH	308
THHN10-OR-SOL-500	282	D3WS15-WH	290	IP650P	301	M2PF-WH	308
THHN10-RD-SOL-1000	282	2DSPS15-IV	290	IP1050P	301	M3PF-WH	308
THHN10-RD-SOL-500	282	2DSPS15-WH	290	IP1030P	301	M4PF-WH	308
THHN10-WH-SOL-1000	282	DSP3WS15-IV	290	IP1450P	301	2BWP-WH	309
THHN10-WH-SOL-500	282	DSP3WS15-WH	290	303P4WSF	301	2BWPTS-WH	309
THHN10-YW-SOL-1000	282	3DSPS15-IV	290	AR-WJD1	302	2BWPTSD-WH	309
THHN10-YW-SOL-500	282	3DSPS15-WH	290	AR-WJR1	302	2DWP-WH	309
THHN8-BE-SOL-1000	283	SPTS15-IV	290	AR-WJT1	302	2WPDR-WH	309
THHN8-BE-SOL-500	283	SPTS15-WH	290	AR-WJTT1	302	WPTSDR-WH	309
THHN8-BK-SOL-1000	283	3WTS15-IV	290	AR-WMB3	302	WPDRD-WH	309
THHN8-BK-SOL-500	283	3WTS15-WH	290	AR-WMD1	302	3WPTS-WH	309
THHN8-BR-SOL-1000	283	DPTS20-IV	290	AR-WMD3	302	3DWP-WH	309
THHN8-BR-SOL-500	283	DPTS20-WH	290	AR-WMR3	302	BWP-IV	310
THHN8-GN-SOL-1000	283	DPTS30-IV	290	AR-WMT1	302	WPFTS-IV	310
THHN8-GN-SOL-500	283	DPTS30-WH	290	AR-WMT3	303	DWP1-IV	310
THHN8-OR-SOL-1000	283	SR120-IV	293	AR-WPR1	303	WP2R-IV	310
THHN8-OR-SOL-500	283	SRT20-WH	293	AR-WPDD3	303	WPSR-IV	310
THHN8-RD-SOL-1000	283	SR220-IV	293	AR-WPRR3	303	M1PF-IV	310
THHN8-RD-SOL-500	283	SR220-WH	293	AR-WPTD3	303	M2PF-IV	310
THHN8-WH-SOL-1000	283	SR115-IV	293	AR-WPTR1	303	M3PF-IV	310
THHN8-WH-SOL-500	283	SR115-WH	293	AR-WPTR3	303	M4PF-IV	310
THHN8-YW-SOL-1000	283	SR220R-IV	293	AR-WPTT1	303	2BWP-IV	311
THHN8-YW-SOL-500	283	SR220R-WH	293	AR-WPTT3	303	2BWPTS-IV	311
THHN6-BE-SOL-1000	284	DDR15-IV	294	WP2G-WH	303	2BWPTSD-IV	311
THHN6-BE-SOL-500	284	DDR15-WH	294	AR-WJD2	304	2DWP-IV	311
THHN6-BK-SOL-1000	284	DRTR15-IV	294	AR-WJD4	304	2WPDR-IV	311
THHN6-BK-SOL-500	284	DRTR15-WH	294	AR-WJT2	304	WPTSDR-IV	311
THHN6-BR-SOL-1000	284	DDTTSGTR20-IV	294	AR-WJT4	304	WPDRD-IV	311
THHN6-BR-SOL-500	284	DDTTSGTR20-WH	294	AR-WJTT2	304	3WPTS-IV	311
THHN6-GN-SOL-1000	284	DRTRUSB15-IV	294	AR-WJTT4	304	3DWP-IV	311
THHN6-GN-SOL-500	284	DRTRUSB15-WH	294	AR-WSB2	304	ARWE1-T	312
THHN6-OR-SOL-1000	284	DRTRUSB20-IV	294	AR-WSD2	304	ARWO1-T	312
THHN6-OR-SOL-500	284	DRTRUSB20-WH	294	AR-WST2	304	ARWG1-T	312
THHN6-RD-SOL-1000	284	DDRTR15-IV	294	AR-WSTD2	304	ARWE2-T	312
THHN6-RD-SOL-500	284	DDRTR15-WH	294	AR86891	305	ARWO2-T	312
THHN6-WH-SOL-1000	284	DR-1-WH	294	ARWW1-2	305	ARWG2-T	312
THHN6-WH-SOL-500	284	AR15AADJR	294	ARWW-C	305	ARWE3-T	312
THHN6-YW-SOL-1000	284	DR15-IV	297	ARWW-D	305	ARWO3-T	312
THHN6-YW-SOL-500	284	DR15-WH	297	AR86092	305	ARWG3-T	312

AR-WR3	313	A19-930	323	ARSEBA5810	332	ARSED500-4	342
AR-WR5	313	A19-950	323	ARSEBA5813	332	ARERV100EC	344
ARLH150-5	316	TM-100W	324	AROD586	332	ARFSE80RVL	345
ARRC-3+2LH150-5	316	TLE/50	325	AROD348	332	ARC02	346
AR-WPRLH	316	TLE/100	325	AROD586D	332	ARC03	346
MSS1	316	TLS/100	325	ARDAB5816	333	ARC04	346
ARXC-1	317	ARYC1	325	ARDAB5818	333	ARC06	346
ARXC-2	317	ARWRC14	328	ARDAB5820	333	ARC10	346
ARRC-1	317	ARWRC38	328	ARDAB5822	333	ARCL01	346
ARRC-2	317	ARGC001	328	ARDAB5824	333	ARCL10	347
ARRC-3	317	ARGC002	328	ARDAIB5818	333	ARCL11	347
ARRC-1-N	317	AR-BDSG	328	AREAB001	334	ARGV-01-SP	347
ARRC-3-N	317	ARPMWH001	329	ARSB-144FO	334	ARGV-BL06	347
ARRE-1	318	ARPMWH002	329	ARENUT58	335	ARGV-BL07	347
ARRE-1-W	318	ARPMWH003	329	ARSN58	335	ARGV-B05	347
ARRE-2	318	ARPMWH004	329	ARSWASHER214	335	ARERV100EC	348
ARRE-2-W	318	ARPMWH005	329	ARFC-1	336	ARFSE80RVL	349
ARRE-3	318	ARPMWH006	329	ARJC-1	336		
ARRE-3-W	318	ARMB5884	330	ARJC-2	336		
ARVPF001	319	ARMB58104	330	ARJC-3	336		
ARVPF002	319	ARMB58126	330	6V4AH	337		
ARLEED2RWEM	320	ARMB58146	330	ARS50	340		
ARLEED2GWEM	320	ARMB58166	330	ARSD50	340		
ARLECD2RW	321	ARMB58186	330	ARS70	340		
ARLEU9L	321	ARCBOLT5884	331	ARSP80	341		
ARLECD2GW	321	ARCBOLT58104	331	ARSPD100-3	341		
ARLTR-G	322	ARCBOLT58126	331	ARSE110P	341		
ARLTR-Y	322	ARSA5836	331	ARSE120P	341		
ARLTR-R	322	ARSA5848	331	ARSEPD140-3	341		
ARLTR-OR	322	ARSA5860	331	ARSEP150	341		
ARLTR-W	322	ARSA3448	331	ARSEP200	341		
A1910WL	323	ARSA3460	331	ARSEPD200	341		
A1912WL5	323	ARSEBS5810	332	ARSEPD300	341		
A1912WL6	323	ARSEBS5812	332	ARSNPD100-3	342		

**www.
ammoelectric.
com**



1 Gang Plaster Ring _____	24, 31
1 Hole Straps, BX _____	208
1 Hole Straps, EMT _____	208
1 Hole Straps, Rigid _____	209
11B 1 Gang Drywall Ring _____	31
11B 1 Gang Plaster Ring _____	31
11B Box _____	29-30
11B Bracket Box _____	30
11B Cover _____	31-33
11B Device Cover _____	31
11B Device Ring _____	31
11B Extension Ring _____	29
11B Junction Box _____	29-30
11B Mud Ring _____	31
11B Plaster Ring _____	31
1900 1 Gang Mud Ring _____	24
1900 1 Gang Plaster Ring _____	24
1900 2 Device Plaster Ring _____	24
1900 2 Gang Plaster Ring _____	24
1900 Box _____	18-23
1900 Box With Bracket _____	20-23
1900 Box With Cable Clamps _____	20-23
1900 Bracket Box With Clips _____	20-23
1900 Cover _____	24-28
1900 Deep Box With Bracket _____	22-23
1900 Deep Box With Clips. _____	22-23
1900 Deep Bracket Box _____	22-23
1900 Deep Bracket Box With Clips _____	22-23
1900 Deep With Bracket _____	20-23
1900 Deep With Metal Stud Bracket _____	20-23
1900 Electrical Box _____	18-23
1900 Extension Rings _____	22-23
1900 Junction Box _____	18-23
1900 Mud Ring _____	24
1900 Plaster Ring _____	24
1900 Square-Round Ring _____	25
2 Hole Strap _____	208-209
2x4 Box _____	47-48
2x4 Box Cover _____	49
4 11/16 Cover _____	31-33
4 11/16 Square-Round Cover _____	33
411/16 Box _____	29-30
4S Box _____	18-23
4S Box Cover _____	24-28
4S Bracket Box _____	20-23
4S Cover _____	24-28
4S Extension Ring _____	22-23
8B Box _____	10, 12-16
8B Box Ceiling Box With Bracket _____	14-15
8B Box with Bracket _____	12-14, 16
8B Box with J Bracket _____	14, 16
8B Ceiling Box With Bracket _____	14-15
8B Cover _____	17
8B Deep Box _____	16
8B Deep Box With Bracket _____	16
8B Deep J Box _____	16
8B Deep Octagon Box _____	16
8B Device Cover _____	17
8B Extension Ring _____	13
8B Octagon Extension _____	13
8B Raised Ring _____	17
90 Degree Compression Connector _____	166
AC Connectors _____	168-171
Acorn Clamps _____	249
Add-A-Depth Ring _____	60
Adjustable Box Mounting _____	
Bar Hangers _____	34-35
Adjustable Box _____	
Mounting Brackets _____	34-35
All Threaded Rod _____	262
Aluminum Conduit Bodies _____	140-141
Aluminum Rigid Conduit _____	105
Aluminum Rigid Couplings _____	119
Aluminum Rigid Elbows _____	112-113
Anchor Rods _____	338
Anchors Expanding _____	340
Anchors Screw Type _____	337
Anti Short Bushings _____	183
Armored Cable Fittings _____	170-171
Bang on Beam Clamp _____	236
Bang on Bushing _____	199
Bar Hangers _____	34-35
Battery _____	343
Beam Clamps _____	236
Biscuit Box _____	11
Black Insulated Connectors _____	212-215
Blank covers _____	61
Blankup Covers _____	319
Boiler Plate _____	318
Bolts _____	336-339
Bolts Double Arming _____	339
Bolts Machine _____	336
Bolts Oval Eye _____	337
Bolts Strand Eye _____	338
Bond Bushings _____	196-197
Bond Clamp _____	250-251
Bonding Bushings _____	196-197
Box Mounting Bar Hangers _____	34-35
Box Mounting Brackets _____	35
Box Mounting Rings _____	35
Bridle Ring Clip _____	244
Bridle Rings _____	243
Bronze Pipe Clamps _____	250-251
Burner Cover _____	318
BX Connectors _____	168-171
BX Strap _____	208
BX to Flex Connectors _____	177
C Purlin Clip _____	236

Cable Connectors _____	168-171
Cable Hangers _____	235
Cable Hooks _____	243
Cable Snap Clips _____	234
Cable Staples _____	211
Cable Storage Bracket _____	340
Cable Support Hook _____	243
Cable Support to Stud _____	245
Cable Ties _____	218-223
Cage Lights _____	328
CAT5 Cable _____	272
CAT6 Cable _____	272-273
Category Cable _____	272-273
Ceiling Blankups _____	319
Ceiling Box Support _____	244
Chain _____	342
Channel Cone Nuts _____	267
Chase Nipples _____	206-207
Clamp Back Spacer _____	210
Coaxial Cable _____	274
Combination Box Conduit Hangers _____	235
Combination Couplings _____	158, 164
Combination Pull Elbows _____	165
Compression Connectors _____	160-161, 163
Compression Couplings _____	162-163
Compression Fittings _____	160-163
Compression Lugs _____	254-257
Conduit _____	92-105, 122-125
Conduit Body _____	126-127, 140-151
Conduit Body Cover _____	147, 149, 152-153
Conduit Bushings _____	198
Conduit Clips _____	226, 232
Conduit Hangers _____	230, 232
Conduit Nipples _____	114-117
Conduit Supports _____	200-203
Connectors Take All _____	182
Covers 4 Square _____	24-25
Covers 4" Industrial _____	26-28
Covers 4-11/16 Square _____	31-33
Covers Multi Gang _____	40-42
Covers Octagon _____	10, 17
Decorative Switches _____	300-301
Drive Straps _____	63
Duplex Connectors _____	168 -176, 178-179
Edge Clamp _____	203
Edge Pipe Clamp _____	203
Elbows _____	108-113, 128-131
Electrical Conduit _____	92-105
Electrical Tape _____	216
Electrical Wire _____	272-287
Emergency Cover Plate _____	318
Emergency LED _____	327
Emergency Wallplates _____	318
EMT Bushings _____	199
EMT Compression Connectors _____	160-161, 153
EMT Compression Couplings _____	162-163
EMT Conduit _____	97
EMT Conduit Bodies _____	146-147
EMT Conduit True Color _____	98-101
EMT Connectors _____	156-157, 159-161, 163
EMT Couplings _____	158, 162-164
EMT Elbow _____	108-109
EMT One Hole Straps _____	208
EMT Set-Screw Connectors _____	156-157, 159
EMT Set-Screw Couplings _____	159
EMT Slip Couplings _____	158
EMT Straps _____	208
EMT to Inside Corner Connector _____	166
EMT to Liquidtight Compression Coupling _____	167
EMT to Rigid Compression Coupling _____	167
EMT Two Hole Straps _____	208
Energy Recovery Ventilator _____	350
ENT Conduit _____	94
Exit Signs _____	326-327
Extension Rings 4 Square _____	23
Extension Rings 4-11/16 _____	29
Extension Rings Multi Device _____	38-39
Extension Rings Octagon _____	13
Fan Accessories _____	352
Fans _____	346-348
Fire Damper _____	354-355
Flange Mount Conduit Clips _____	226, 228-229
Flex Connectors _____	168-171
Flexible Aluminum Conduit _____	93
Flexible Liquid Tight Conduit _____	95-96
Flexible Steel Conduit _____	92
Flourescent Chain _____	340
Form 5 Conduit Bodies _____	148-149
Form 7 Conduit Bodies _____	150-152
Gas Burner Plates _____	318
GFCI _____	298-299
GFCI Device _____	298-299
GFCI Receptacle _____	298-299
GFCI Receptacle _____	298-299
GFI Device _____	298-299
GFI Outlet _____	298-299
Ground Rod _____	248
Ground Rod Clamp _____	249
Ground Screw _____	259
Grounding Busbar _____	258
Grounding Bushings _____	196-197
Grounding Clamps _____	250-251
Grounding Hubs _____	250
Grounding Locknuts _____	205
Grounding Pigtails _____	259
Guy Clamps _____	334
Hammer On Flange Clip _____	237

Hammer On Threaded Rod Hangers	227	Nail Straps	63
Handy Box	47-48	NM Connectors	168-171, 181
Handy Box Cover	49	NM Snap In Connectors	183
Handy Box Extension Ring	47-48	Non-Metallic Liquid	
Handy Box with Bracket	47	Tight Connectors	184-185
Hanger Bars	34-35	Nuts	341
Hexagon Nuts	269	Octagon Box	10, 12-16
Hospital Grade Receptacles	298-299	Octagon Box With Bar Hanger	14-15
IMC Conduit	103	Octagon Bracket Box	12-14
Industrial Plugs	308-309	Octagon Ceiling Box	14-15
Industrial Receptacles	308-309	Octagon Concrete Ring Covers	46
Insulating Bushings	199	Octagon Concrete Rings	45
J Hooks	243	Octagon Conduit Box	10, 12-16
Jack Chain	342	Octagon Cover	10, 17
Job Site Lighting	328, 330-331	Octagon Device Cover	17
Knockout Filler	64	Offset Connectors	166
Knockout Insert	64	Offset Nipples	207
Knockout Plug	64	Oil Burner Plates	318
Knockout Seal	64	Oil Switch Plates	318
Lampholder Covers	323-324	One Gang Lampholder Covers	324
Lampholder Weatherproof	322	Pan Box	11
Lampholders	322	Pancake Box	11
Lamps	329	Parallel Clamp	202
Lay-in Lugs	253	Parallel Conduit Supports	202
LED Exit Signs	326-327	Pipe Mounting Wireholders	335
LED String Lights	331	Plastic Extension Rings	68-69
LED Work Light	330	Plastic Wallplates	314-317
Light Bulbs	329	Plugs Industrial	308-309
Line Supplies	334-343	Porcelain Wire Holders	335
Liquid Tight Connectors	184-191	Portable String Light	330
Locknuts	205	Pull Elbows	165
Lugs	252-257	PVC Box Adapter	134
Machine Bolts	336	PVC Boxes	65-67
Malleable Conduit Bodies	148-151	PVC Combination Pull	137
Malleable Iron Beam Clamps	236	PVC Conduit	122-123
Masonry Box	43	PVC Conduit Bodies	126-127
MC Connectors	168-171	PVC Couplings	133
MC/AC/NM Cable Clips	233	PVC Elbows	128-129
Mechanical Lugs	252	PVC End Cap	133
Metal Wallplates	308-313	PVC Expansion Coupling	133
Meter Offset	136	PVC Male Adapter	135
Minnies	232	PVC New Work Boxes	65-66
Mogul Conduit Body	142-143	PVC Offset Connector	135
Motion Sensors	322	PVC Old Work Boxes	67
Multi Gang Box Covers	42	PVC Reducing Bushing	134
Multi Gang Device Covers	40-41	PVC Service Entrance Cap	89, 136
Multi Gang Switch Box	36-37	PVC Straps	135
Multi Gang Switch Box		PVC Terminal Adapters	132
Extension Rings	38-39	Raintight Compression Connectors	163
Multi-Device Switch Box	36-37, 44	Raintight Compression Couplings	163
Multi-Function Clips	231	Raintight Fittings	163
Nail Drive Straps	63	Receptacles	302-307
Nail Plates	63	Receptacles Industrial	308-309
Nail Safety Plates	63	Red Indicator Plates	318

Reducing Bushings _____	198
Reducing Washers _____	62
Residential Receptacles _____	302-307
Residential Switches _____	300-301
RG6 Cable _____	274
Rigid Compression Connectors _____	192, 194
Rigid Compression Couplings _____	192, 194
Rigid Conduit _____	102
Rigid Conduit Nipples _____	114-117
Rigid Couplings _____	118-119
Rigid Elbows _____	110-113
Rigid IMC Conduit Bodies _____	144-145
Rigid One Hole Straps _____	209
Rigid Raintight Connectors _____	193
Rigid Raintight Couplings _____	193
Rigid Set Screw Couplings _____	194
Rigid Straps _____	209
Rigid Threaded Bushings _____	199
Rigid Three Piece Couplings _____	195
Rigid Two Hole Straps _____	209
Rocker Switches _____	300-301
Rod and Wire Hangers _____	241
Round Lampholder Covers _____	324
Screw in Flex Connectors _____	180
Screw in Flex Couplings _____	182
Sealing Locknuts _____	205
Service Clamp _____	88-89
Service Entrance Caps _____	88-89, 136
Service Entrance Kits _____	89
Service Entrance Mast Kit _____	89
Set Screw Connectors _____	156-157
Set Screw Couplings _____	158-159
Set Screw EMT Connectors _____	156-157
Set Screw Fittings _____	156-159
Single Receptacles _____	302-303
Slip Couplings _____	158
Snap In Bushing _____	183
Snap In Knockout Seals _____	64
Snap In KO Seal _____	64
Snap In Plugs _____	64
Solderless Lugs _____	253
Split Bolts _____	249
Spring Nuts _____	267
Square Washers _____	341
Squeeze Connectors _____	171-175
Steel Rigid Elbows _____	110-111
Strap Hanger for Z Purlin Clip _____	242
String Light _____	331
String Light Cage _____	331
Strut _____	263-264
Strut Channel Covers _____	267
Strut Clamps _____	266
Strut Fittings _____	265
Stud Wall Cable Support _____	245
Support Grip _____	334
Switch Box with Bracket _____	50-51, 54-59
Switch Boxes _____	50-59
T Grid Box Hanger _____	239
T Grid Clip _____	240
Take All Connectors _____	182
Tamper Resistant Devices _____	298-299
Temp Lights _____	328, 330-331
Temporary Work Lights _____	328, 330-331
THHN Wire _____	275-291
Threaded Bushings _____	199
Threaded Rod _____	262
Three Piece Knockout Seals _____	64
Top-Bite Combination Couplings _____	164
Top-Bite Connectors _____	177
True Color EMT Conduit _____	98-101
Twist Clip _____	239-240
Universal Snap In Bushing _____	183
USB Devices _____	298-299, 304-305
Utility Service Caps _____	88-89
Vapor Tight Light Fixture _____	87, 325
Ventilation Fans _____	346-348
Ventilator Energy Recover _____	350
Ventilator Fan Accessories _____	352
Ventilator Fan Grilles _____	352-353
Ventilator Fan Plate _____	351
Ventilator Fans with Bracket _____	347-348
Wallplates _____	310-317
Wallplates Burner _____	318
Wallplates Emergency _____	318
Wallplates Gas _____	318
Wallplates Metal _____	310-313
Wallplates Oil _____	318
Wallplates Plastic _____	314-317
Wallplates Stainless _____	313
Washers Square _____	341
Washers USS Flat _____	268
Watertight Hubs _____	204
Weatherproof Box _____	72-77
Weatherproof Covers _____	80-82
Weatherproof In Use Covers _____	83
Weatherproof Junction Box _____	72-77
Weatherproof Lampholder _____	85, 322
Weatherproof Lampholder Cover _____	87
Weatherproof Round Box _____	84
Weatherproof Round Cover _____	86
Weatherproof Round Extension Ring _____	84
White Blankup Covers _____	319
Wire _____	272-287
Wire Nut Connectors _____	217
Wire Rope Clips _____	334
Work Light _____	328, 330-331
Z Purlin Clips _____	238



CONTACT US:
718 338 1851
info@ammoelectric.com
www.ammoelectric.com
1000 Commerce Center Dr
Elkton MD 21921