



CATEGORY
**ELECTRICAL
FITTINGS**

AMMO ITEM #

ARCCNS-150

Company: _____
Job: _____ #Item: _____
Notes: _____

EMT Compression Connector



FEATURES

- Compression type connector
- Concrete tight
- Assembled with a steel locknut
- Available with insulated throat

MATERIAL

Steel with Zinc Plated

MEASUREMENTS

- Depth: _____ 1-1/2 in
- A: _____ 2.76 in
- B: _____ 2.20 in
- C: _____ 0.55 in

PACKAGING

- Weight: _____ 71 g
- PKG: _____ 20
- UPC Number: _____ 837654088197

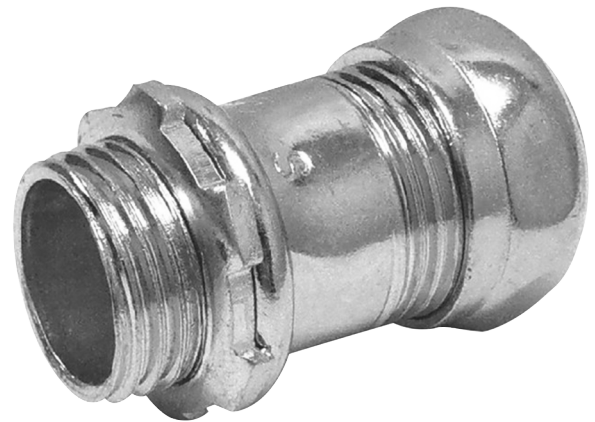
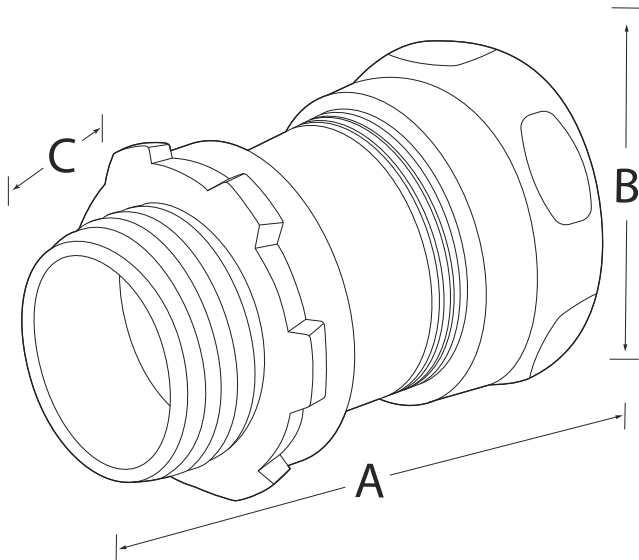

ELECTRICAL FITTINGS



400 MARTIN LUTHER KING JR WAY, BRIDGETON, NJ 08302
PHONE : (718).338.1851 FAX : (718).228.1851
orders@ammoelectric.com

www.ammoelectric.com